



PG.55



PG.30



PG.35



PG.63



PG.118



SINCE 1983



PG.55



PG.55

AIR TOOLS	BOOSTERS	BODY TOOLS	DIAGNOSTIC
HAND TOOLS	SPECIALTY TOOLS	TOOL BOXES	TRUCK EQUIPMENT



Tool & Equipment Warehouse Inc.

TM

MECHANIC'S TOOL CLUB™

JOIN THE CLUB & SAVE!

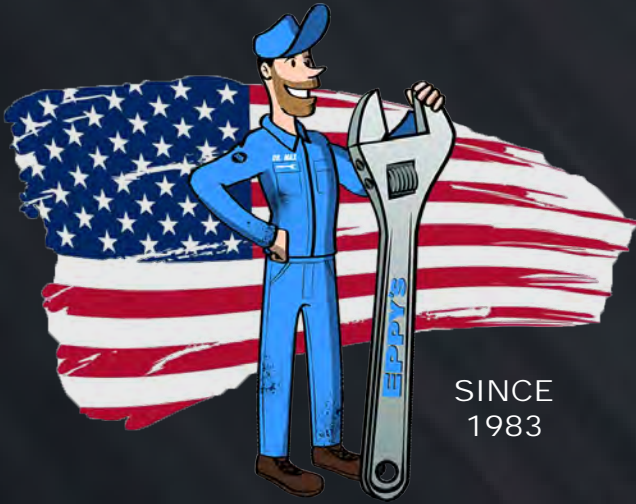

CLUB MEMBER

\$12.00 ANNUAL FEE
SAVE 20% FOR ONE YEAR

LIFE MEMBER

\$60.00 ONE-TIME FEE
SAVE 22% FOREVER

Eppy's offers two types of memberships with everyday savings. Not a member? No problem. We offer a broad range of Automotive Tool & Equipment to all! Stop by our NY or NJ location or shop at www.eppys.com to view 100+ brands and 100,000+ products!

- ✓ FAST DELIVERY
- ✓ COMPETITELY PRICED
- ✓ NY / NJ SHOWROOMS & WAREHOUSE
- ✓ QUALITY SERVICE
- ✓ WARRANTY ASSISTANCE
- ✓ FACTORY AUTHORIZED DISTRIBUTOR



NEW SHIPPING POLICY

\$15 FLAT-FEE RATE

On All Orders Less Than 20lbs.
Some exclusions may apply.

ORDERS SHIP OUT DAILY

On Orders placed before 2PM EST
Via UPS, USPS, or Truck Freight

FREE DELIVERY

Orders \$200.00 + and within a 20 mile radius from NY or NJ store location.
Some exclusions may apply.

WE'RE HIRING!

Looking for a new career? We're hiring! Send your resume to tools@eppys.com

NEW YORK

809 EAST 42ND ST
BROOKLYN, NY 11210
BTWN GLENWOOD RD & FARRAGUT RD

TEL: 718-434-7878
FAX: 718-434-9317
SALES@EPPYS.COM

MONDAY - FRIDAY
SATURDAY
SUNDAY

8:00 AM - 5:00 PM
9:00 AM - 4:00 PM
CLOSED



NEW JERSEY

2777 ROUTE 9 N
HOWELL, NJ 07731
JUST NORTH OF INTERSTATE 195

TEL: 732-942-3700
FAX: 732-942-3707
SALES@EPPYS.COM

MONDAY
TUESDAY - FRIDAY
SATURDAY
SUNDAY

CLOSED
9:00 AM - 6:00 PM
9:00 AM - 4:00 PM
10:00 AM - 4:00 PM

Due to the ongoing material inflation some catalog prices are subject to change before 3/31/2024. Some quantities limited.



SEE INDEX PAGE 123 ->

RATCHETING WRENCHES

GW GEARWRENCH

KDT86727
12pc 12PT
Ratcheting
METRIC
Flex-Head
Wrench Set
Sizes: 8mm - 19mm
Sale \$249.94
Tool Club \$199.95



MM

KDT86928
16pc 12PT
Ratcheting
METRIC
Wrench Set
Sizes: 8mm - 19mm
21mm - 25mm
Sale \$249.94
Tool Club \$199.95



MM

NEW! **GW GEARWRENCH**

KDT86758
10pc 12PT
Ratcheting
SAE Flex-Head
Wrench Set
Sizes: 1/4" - 3/4"
Sale \$187.44
Tool Club \$149.95



SAE

KDT86959
14pc 12PT **SAE**
Ratcheting
Wrench Set
Sizes: 1/4" - 1"
Sale \$224.94
Tool Club \$179.95



SAE



MM

KDT85988
12 Pc. 72-Tooth 12 Pt. Double Box
Ratcheting Metric Wrench Set
8, 9, 10, 11, 12, 13, 14, 15, 16, 17, 18
and 19mm
Sale \$249.94 **Tool Club \$199.95**

GW GEARWRENCH



SAE

KDT86831
4pc Ratcheting Extra
Long Flex Head 12PT Wrench Set
5/16"x3/8", 7/16"x1/2",
9/16"x5/8", 11/16 x3/4"
Sale \$156.19 **Tool Club \$124.95**

GW GEARWRENCH



NEW!

MM

KDT86830
6pc Ratcheting **METRIC** Extra
Flex Head Wrench Set
8mm x 10mm, 9mm x 11mm, 12mm x
14mm, 13mm x 15mm, 16mm x 18mm
& 17mm x 19mm
Sale \$246.19 **Tool Club \$196.95**



MM

KDT9416
16pc Ratcheting Master **METRIC**
Sizes: 8 to 24mm.
Sale \$224.94
Tool Club \$179.95



MM

KDT9901D
12pc Ratcheting **METRIC** Flex
Sizes: 8 to 19mm.
Sale \$249.94
Tool Club \$199.95



MM

KDT9412
12pc Ratcheting **METRIC** Set
Sizes: 8 to 19mm.
Sale \$129.94
Tool Club \$103.95



SAE

KDT9312
12pc Ratcheting Master **SAE**
Sizes: 1/4" to 1".
Sale \$199.94
Tool Club \$159.95



SAE

KDT9701
8pc Ratcheting **SAE** Flex
Sizes: 5/16" to 3/4".
Sale \$237.44
Tool Club \$189.95



SAE

KDT9308D
8pc Ratcheting **SAE** Wrench Set
Sizes: 5/16" - 3/4".
Sale \$137.44
Tool Club \$109.95

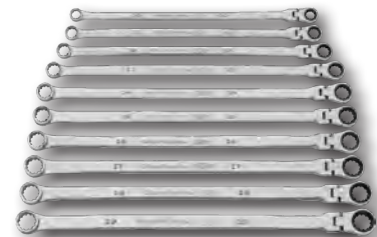

SAE

KDT86142
10pc Ratcheting **SAE** XL Flex
Gearbox Wrench Set
Sizes: 1/4" - 3/4".
Sale \$312.44 **Tool Club \$249.95**

X-FRAME RATCHETING WRENCHES

• 1.7° arc swing - lowest in the industry! • 216 ratcheting positions • 5x ANSI spec for torque • I-Beam handle distributes force evenly • SureGrip open end design • LIFETIME WARRANTY

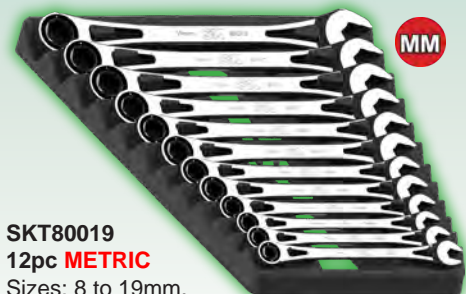

MM

SKT80019
12pc **METRIC**
Sizes: 8 to 19mm.
Sale \$299.94 **Tool Club \$239.95**



SAE

SKT80049
7pc **SAE**
Sizes: 3/8" - 3/4".
Sale \$187.44 **Tool Club \$149.95**

SK
PROFESSIONAL TOOLS

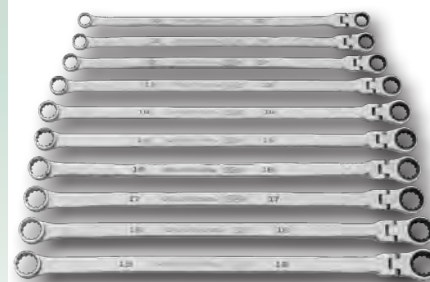

MM

KDT86126
10pc Ratcheting **METRIC**
XL Flex Gearbox Wrench Set
Sizes: 10 - 19mm.
Sale \$337.44 **Tool Club \$269.95**

WRENCHES

METRIC CROWFOOT WRENCHES

SUN9710M
10pc METRIC
Flare Nut
 Sizes: 10 - 19mm
 Sale \$45.94
Tool Club \$36.75



KDT81909
10pc METRIC
Flare Nut
 Sizes: 10 - 19mm
 Sale \$96.19
Tool Club \$76.95



SUN9740
7pc METRIC
Jumbo Sizes:
 34, 35, 36, 38,
 41, 42, & 46mm.
 Sale \$114.06
Tool Club \$91.25



VIMSCF14
1/4" Drive Spring
Loaded Multi Wrench
 Sale \$21.88 **Tool Club \$17.50**



VIMSCF38
3/8" Drive Spring
Loaded Multi Wrench
 Sale \$28.13 **Tool Club \$22.50**



VIMSCF12
1/2" Drive Spring
Loaded Multi Wrench
 Sale \$35.63 **Tool Club \$28.50**



VIMSCF12XL
1/2" DR XL Spring-Loaded
 Sale \$78.13 **Tool Club \$62.50**



SAE CROWFOOT WRENCHES

SUN9708 **SUNEX TOOLS**
8pc SAE
 Sizes: 3/8" to 7/8"
 Sale \$35.63
Tool Club \$28.50



KDT81908
11pc SAE
Flare Nut
 Sizes: 3/8", 7/16",
 1/2", 9/16", 5/8",
 11/16", 3/4",
 13/16", 7/8",
 15/16" & 1".
 Sale \$106.19
Tool Club \$84.95



SUN9721
14pc SAE
Jumbo
Crowfoot
 1-1/16", 1-1/8",
 1-3/16", 1-1/4",
 1-5/16" & 1-3/8", 1-7/16", 1-1/2", 1-5/8",
 1-11/16", 1-3/4", 1-13/16", 1-7/8", 2".
 Sale \$137.44
Tool Club \$109.95



SUN9720
7pc SAE
Jumbo Sizes:
 1", 1-1/16", 1-1/8",
 1-3/16", 1-1/4",
 1-3/8" & 1-1/2".
 All 1/2" drive.
 Sale \$87.44
Tool Club \$69.95



SUN9722
6pc SAE
Jumbo Sizes:
 1-5/8", 1-3/4",
 1-7/8", 2",
 2-1/8" & 2-1/4".
 All 1/2" drive.
 Sale \$137.44
Tool Club \$109.95



FLARE NUT WRENCHES

KDT81911D
6pc METRIC
Swivel Flare Nut
 Sizes: 9-19 & 21mm.
 Sale \$162.44
Tool Club \$129.95

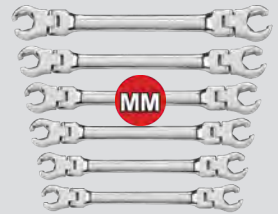

KDT81910
5pc SAE
Swivel Flare Nut
 With flex heads.
 Sizes: 1/4", 5/16", 3/8",
 7/16", 1/2", 9/16", 5/8",
 11/16", 3/4", & 13/16".
 Sale \$137.44
Tool Club \$109.95



SUN9809
9pc SAE & METRIC
Flare Nut Wrench Set
 SAE: 1/4" to 11/16"
 METRIC: 8, 9, 10, 12, 13,
 14, 15, 17, 19 & 21mm.
 Sale \$62.44
Tool Club \$49.95



SUN910MTAS
10pc 3/8" Dr. METRIC
Torque Adapter Set
 10mm - 19mm. 2" long. 12 Point.
 Sale \$102.81 **Tool Club \$82.25**



SUN909TAS
9pc 3/8" Dr. SAE Torque Adapter Set
 Sizes: 1/4" - 3/4". 2" long. 12 Point.
 Sale \$96.19 **Tool Club \$76.95**



VIMRFW100 **NEW!**
6pc 3/8" Ratcheting
Flare Nut Wrench Set
 10mm - 19mm.
 Sale \$156.19
Tool Club \$124.95



VIMRFW200 **NEW!**
5pc 1/2" Ratcheting
Flare Nut Wrench Set
 Sizes: 22, 24, 27, 30, 32mm
 Sale \$249.94
Tool Club \$199.95



THIN WRENCHES



WILW30683
7pc SAE Super Thin Wrench Set
 Sizes: 3/8" - 1-1/4"
 Sale \$47.81 **Tool Club \$38.25**



WILW30684
7pc METRIC Super Thin Wrench Set
 Sizes: 8mm - 32mm
 Sale \$47.81 **Tool Club \$38.25**



VIMSFW100
4pc SAE Flat Wrench Set
 Sizes: 1/4" - 3/4". Long length,
 extended reach. Super thin for limited access.
 Sale \$55.63 **Tool Club \$44.50**



VIMMFW100
7pc Metric Flat Wrench Set
 Sizes: 6mm - 19mm. Long length,
 extended reach. Super thin for limited access.
 Sale \$86.19 **Tool Club \$68.95**



VIMSFW200
4Pc. Large Flat
Wrench Set - SAE
 13/16" - 1-1/4"
 Sale \$174.94 **Tool Club \$139.95**



VIMMFW200
5 Pc. Large Flat
Wrench Set - METRIC
 20mm-32mm
 Sale \$187.44 **Tool Club \$149.95**



METRIC & SAE (INCH) WRENCH SETS

WRENCHES

COMBINATION

WILW1086
8pc **METRIC**
Offset Box
Wrench Set
Sizes: 6mm - 22mm.
Sale \$27.44
Tool Club \$21.95



WILW1085
8pc **SAE**
Offset Box
Wrench Set
Sizes: 1/4 - 7/8".
Sale \$27.44
Tool Club \$21.95



SUN9707M
7pc **METRIC**
Jumbo Sizes
Sizes:
33, 34, 36,
38, 41, 46 & 50mm
Sale \$174.94
Tool Club \$139.95



SUNEX
TOOLS
SUN9715
14pc **METRIC**
Raised Panel
Wrench Set
Sizes: 6 to 19mm
Sale \$87.44
Tool Club \$69.95



SUNEX
TOOLS
SUN9707
7pc **SAE**
JUMBO SIZES
Wrench Set
Sizes:
1-5/16", 1-3/8",
1-1/2", 1-5/8",
1-3/4", 1-7/8" & 2"
Sale \$174.94
Tool Club \$139.95



SUNEX
TOOLS
SUN9714
14pc **SAE**
Wrench Set
Sizes: 3/8", 7/16", 1/2",
9/16", 5/8", 11/16", 3/4",
13/16", 7/8", 15/16", 1",
1-1/16", 1-1/8" & 1-1/4"
Sale \$86.56
Tool Club \$69.25



SUNEX
TOOLS
SUN9915
14pc **SAE**
Long Pattern
Wrench Set
Sizes: 3/8",
7/16", 1/2", 9/16",
5/8", 11/16", 3/4", 13/16",
7/8", 15/16", 1", 1-1/16",
1-1/8" & 1-1/4"
Sale \$106.19
Tool Club \$84.95



LONG PATTERN

SUN9918M
5pc **METRIC**
Long Pattern
Wrench Set
Sizes: 20 to 24mm
Sale \$59.69
Tool Club \$47.75



SUN9917M
12pc **METRIC**
Long Pattern
Wrench Set
Sizes: 8 to 19mm
Sale \$59.69
Tool Club \$47.75



STUBBY WRENCHES

SUN9930M
11pc **METRIC**
Stubby Wrench Set
Sizes: 10 to 19mm
Sale \$47.81
Tool Club \$38.25



SUNEX
TOOLS
SUN9930
10pc **SAE** Stubby Set
Wrench Set
Sizes: 3/8", 7/16", 1/2",
9/16", 5/8", 11/16",
3/4", 13/16", 7/8" & 1"
Sale \$59.06
Tool Club \$47.25



HALF MOON BOX

SUN9935M
5pc **METRIC** Half Moon Wrench Set
Wrench Set
Sizes: 8 - 22mm
Sale \$43.13 **Tool Club \$34.50**



SUNEX
TOOLS
SUN9935
5pc **SAE** Half Moon Wrench Set
Wrench Set
Sizes: 5/16" to 7/8"
Sale \$43.13 **Tool Club \$34.50**



V-GROOVE

SUN9917MPRA
25pc **METRIC** V-Groove
Wrench Set
Wrench Set
Sizes: 8 - 32mm
Sale \$237.44
Tool Club \$189.95



SUN9919MA
8pc **METRIC** V-Groove
Wrench Set
Wrench Set
Sizes: 25mm - 32mm
Sale \$137.44 **Tool Club \$109.95**

ANGLED HEAD OPEN END

SUN9914
14pc **SAE**
Angled Head Open End
Wrench Set
Sizes: 3/8",
7/16", 1/2",
9/16", 5/8",
11/16", 3/4",
13/16", 7/8",
15/16", 1", 1-1/16",
1-1/8" & 1-1/4"
Sale \$103.13
Tool Club \$82.50



SUNEX
TOOLS
SUN9916
6pc **SAE**
JUMBO
SIZES:
1-3/8", 1-1/2",
1-5/8", 1-3/4",
1-7/8" & 2"
Sale \$183.13
Tool Club \$146.50



SUNEX
TOOLS
SUN9926
6pc **METRIC**
JUMBO Wrench Set
Wrench Set
Sizes: 20, 21, 22,
23, 24, 25mm.
Sale \$60.63
Tool Club \$48.50



SUNEX
TOOLS
SUN9927
7pc **METRIC**
JUMBO
Wrench Set
Wrench Set
Sizes: 26, 27,
28, 29, 30, 31,
32mm.
Sale \$110.94
Tool Club \$88.75



VIMWE15
15" Wrench Extender
Sale \$59.94 **Tool Club \$47.95**



SUNEX[®] TOOLS 12 POINT

SUN97010
10pc **SAE** JUMBO
Combination Wrench Set
• Raised panel design
• Forged from high quality carbon steel
• Meets or exceeds ANSI specs
• Includes canvas pouch
• Lifetime Warranty
• Sizes: 1-5/16", 1-3/8", 1-7/16", 1-1/2",
1-5/8", 1-11/16", 1-3/4", 1-7/8", 1-13/16", 2"
Sale \$274.06 **Tool Club \$219.25**



JUMBO SAE

SUN9604
4pc **SAE** JUMBO Combination Wrench Set
• Raised panel design
• Forged from high quality carbon steel
• Meets or exceeds ANSI specs
• Includes canvas pouch
• Lifetime Warranty
• Sizes: 2-1/8", 2-3/8", 2-1/4", 2-1/2"
Sale \$288.69 **Tool Club \$230.95**





IRT752017
66pc 1/4" Dr.
SAE/Metric Master Mechanics Tool Set
 1/4" Dr. ratchet, 6" extension, SAE Short & Deep: 3/16" - 1/2". Metric Short: 4mm - 12mm; Deep: 4mm - 13mm.
 Sale \$99.94 **Tool Club \$79.95**



IRT752018
68pc 3/8" Dr.
SAE/Metric Master Mechanics Tool Set
 3/8" Dr. 72 tooth sealed head ratchet, 3" & 6" extensions, U-Joint & bit adapter.
 6PT SAE Short: 3/8" - 7/8"; Deep: 3/8" - 7/8"
 12PT Metric Short: 8mm - 19mm.
 6PT Metric Deep: 8mm - 19mm.
 Sale \$112.44 **Tool Club \$89.95**



IRT752020
101pc SAE/Metric Master Mechanics Tool Set
 1/4", 3/8", 1/2", Drive Tools, Metric & SAE Short & Deep, Hex Bit Sockets, Tamper-Proof Torx extensions, U-Joint
 Sale \$179.94 **Tool Club \$143.95**



IRT752000
47pc 1/4" Dr.
SAE/METRIC Socket & Accessory Set
 1/4" Dr. ratchet, 3 in. and 6 in. extensions, 6PT SAE Short: 5/32" - 1/2". 6PT SAE Deep: 5/32" - 1/2". 6PT Metric Short: 4, 4.5, 5, 5.5, 6 - 13mm 6PT Metric Deep: 4, 5, 5.5, 6 - 13mm
 Sale \$134.94 **Tool Club \$107.95**



IRT752001
49pc 3/8" Dr. SAE/METRIC Master Socket & Accessory Set
 3/8" Dr. ratchet, 3", 6" & 10" extensions 12PT SAE Short: 3/8" - 7/8". 6PT SAE Deep: 3/8" - 7/8". 12PT Metric Short: 8mm - 19mm. 6PT Metric Deep: 8mm - 19mm.
 Sale \$174.94 **Tool Club \$139.95**

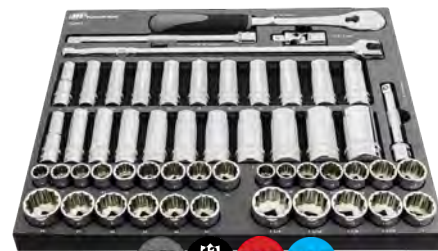

IRT752002
54pc 1/2" Dr. SAE/METRIC Master Socket & Accessory Set
 1/2" Dr. 90 tooth sealed head ratchet, 17" flex handle, 5" & 10" extensions & U-Joint. 12PT SAE Short: 9/16" - 1-1/4". 6PT SAE Deep: 9/16" - 1-1/8". 12PT Metric Short: 14mm - 27mm, 30mm. 6PT Metric Deep: 14mm - 24mm.
 Sale \$268.69 **Tool Club \$214.95**



IRT752025
19pc Master Ratchet & Socket Accessory Kit
 1/4", 3/8" & 1/2" Dr. Ratchets. 1/4" Dr.: 3" & 6" extensions, & U-Joint. 3/8" Dr.: 10" flex handle, 3", 6", & 10" extensions, U-Joint & 3/8" F x 1/4" M adapter. 1/2" Dr.: 17" flex handle, 3", 5" & 10" extensions, U-Joint & 1/2" F x 3/8" M adapter. Includes laser-cut foam organizer tray.
 Sale \$247.44 **Tool Club \$197.95**



IRT752057
11pc Long Pattern Metric Set
 Sizes: 8, 10, 11, 12, 13, 14, 15, 16, 17, 18 & 19mm
 Sale \$89.94 **Tool Club \$71.95**

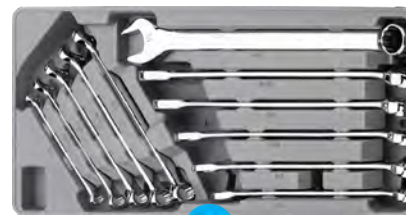

IRT752058
16pc Long Pattern SAE Set
 Sizes: 1/4, 5/16, 3/8, 7/19, 1/2, 9/16, 5/8, 11/16, 3/4, 13/16 & 7/8"
 Sale \$89.94 **Tool Club \$71.95**



IRT752003
66pc Master Torx & Specialty Bit Socket Set
 E-Torx, Tamper-Proof, Torx Long Reach 4" 3/8" Dr. Hex Sockets, SAE & Metric 4" Long Hex Sockets, Triple Square XZN Sockets
 Sale \$224.94 **Tool Club \$179.95**

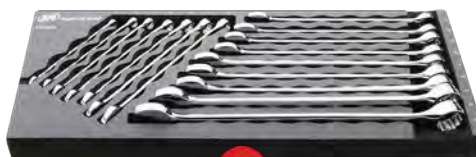

IRT752009
16pc Master Metric Set
 Sizes: 6, 7, 8, 9, 10, 11, 12, 13, 14, 15, 16, 17, 18, 19, 21, & 22mm
 Sale \$174.94 **Tool Club \$139.95**

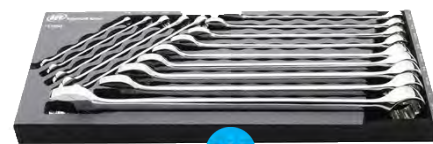

IRT752008
14pc Tech Solutions Master Non-Slip Combination Wrench Set - SAE
 1/4, 5/16, 3/8, 7/16, 1/2, 9/16, 5/8, 11/16, 3/4, 13/16, 7/8, 15/16, 1, 1-1/8
 Sale \$174.94 **Tool Club \$139.95**





KDT80300
51pc 1/4" Drive SAE & Metric
 Short: 3/16" - 9/16"; 4 - 15mm
 Deep: 3/16" - 9/16"; 4 - 15mm
 Ratchet, Thumbwheel, U-Joint,
 2" & 5" extensions.



Sale \$131.19 **Tool Club \$104.95**



KDT80550
57pc 3/8" Drive SAE & Metric
 Short: 1/4" - 1"; 4 - 19mm
 Deep: 1/4" - 7/8"; 4 - 19mm
 Regular & Stubby Ratchets,
 U-Joint, 3" & 6" extensions.



Sale \$181.19 **Tool Club \$144.95**



KDT80700D
49pc 1/2" Drive SAE & Metric
 Short: 7/16" - 1-1/8"; 10 - 24mm
 Deep: 1/2" - 15/16"; 4 - 19mm
 Ratchet, U-Joint,
 3" & 5" extensions.



Sale \$274.94 **Tool Club \$219.95**



KDT86529
83pc 1/4", 3/8", 1/2" 90-Tooth SAE & Metric
Mechanics Tool Set with EVA Foam Tray
 90-tooth gear delivers a 4° swing arc to turn a
 fastener in tight confines. 6pt full polish chrome
SAE & Metric 1/4, 3/8" and 1/2" standard
 Sale \$374.94 **Tool Club \$299.95**



KDT80942
219pc Mechanic's Tool Set
 1/4", 3/8" & 1/2" Drive, 6 & 12 PT **SAE & Metric.**
 Includes ratchets, drivers, wrenches,
 extensions and allen keys.
 Sale \$474.94 **Tool Club \$379.95**



KDT80966
243pc Mechanic's Tool Set
 1/4", 3/8" & 1/2" Dr. 6PT **SAE & Metric.**
 Includes short & 1/4" & 3/8" Dr.
 Deep Sockets, ratchets, wrenches,
 torx, extensions, bit driver w/ bits!
 Sale \$524.94 **Tool Club \$419.95**

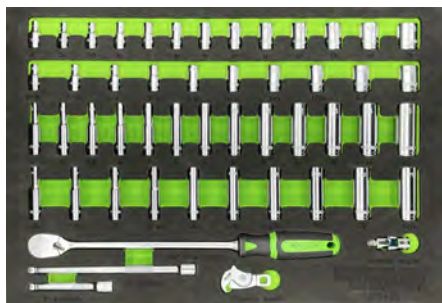

VIMSMS400
51pc 1/4" Dr. Socket Master Set
 Set includes: Shallow and deep sockets in
 sizes 4mm to 15mm and 3/16" to 9/16", a Pro
 10" 90-Tooth 1/4" Dr. Heavy Duty ratchet, two
 extensions, a spring loaded crowfoot wrench
 and a spring loaded universal joint
 Sale \$156.19 **Tool Club \$124.95**



VIMSMS600
52pc 3/8" Dr. Socket Master Set
 Set includes shallow and deep sockets in
 sizes 8mm through 19mm and 1/4" through
 7/8", and 14" 90-Tooth 3/8" Dr. Heavy Duty
 Ratchet
 Sale \$231.19 **Tool Club \$184.95**



CTA1189
17pc Deep Metric Socket Set
 Sizes: 6mm - 21mm. Sockets are 120mm long
 & deep broched for extra-deep reach. Provides
 access to recessed areas with extra long bolts, as
 found on some bumpers, rear lamps, glow plugs &
 door ginge fittings. Sockets are 3/8" & 1/2" drive.
 Includes 1/2"Fx3/8"M & 3/8"Fx1/4"M adapters.
 Sale \$237.44 **Tool Club \$189.95**



MLW48-22-9004
50pc 1/4" Dr. SAE/Metric Ratchet & Socket Set
 Short Sizes: 5/32" - 9/16"; 5mm - 15mm;
 Deep Sizes: 5/32" - 9/16"; 5mm - 15mm;
 Includes: 1/4" Dr. ratchet, 3" & 6" extensions,
 U-Joint & storage case w/ removable tray.
 Sale \$149.94 **Tool Club \$119.95**



MLW48-22-9008
56pc 3/8" Dr. SAE/Metric Ratchet & Socket Set
 Short Sizes: 1/4" - 1"; 6mm - 19mm;
 Deep Sizes: 1/4" - 7/8"; 6mm - 19mm;
 Includes: 3/8" Dr. Ratchet, 3" & 6" extensions,
 U-Joint & storage case w/ removable tray.
 Sale \$189.38 **Tool Club \$151.50**



MLW48-22-9486
106pc 1/4" & 3/8" SAE/Metric Ratchet & Socket Set
 Includes: 1/4" Dr. Ratchet, 3" & 6" ext., & U-Joint;
 3/8" Dr. Ratchet, 3" & 6" ext., & U-Joint.
 1/4" Short Sizes: 5/32" - 9/16"; 5mm - 15mm.
 1/4" Deep Sizes: 5/32" - 9/16"; 5mm - 15mm.
 3/8" Short Sizes: 1/4" - 1"; 6mm - 19mm.
 3/8" Deep Sizes: 1/4" - 7/8"; 6mm - 19mm.
 Comes in a PACKOUT™ Low-Profile organizer.
 Sale \$393.69 **Tool Club \$314.95**

MASTER SETS



SKT91848
48pc 1/4" Drive SAE & Metric
 Short: 3/16" - 9/16"; 4 - 15mm
 Deep: 1/4" - 9/16"; 6 - 15mm
 Ratchet, 2 adapters, Thumbwheel, U-Joint, & 2 Extensions
 Sale \$262.44 **Tool Club \$209.95**



SKT91860
60pc 1/4" Drive SAE & Metric
 Short: 1/8" - 5/8"; 4 - 16mm
 Deep: 1/8" - 9/16"; 4 - 15mm
 Ratchet, 2 adapters, U-Joint, & 2 Extensions
 Sale \$374.94 **Tool Club \$299.95**



SKT94562
41pc 1/4" Drive Metric
1/4" Drive
 Short: 4 - 15mm; Deep: 5.5-15mm
 Ratchet, Extensions, & Adapter
3/8" Drive
 Short: 6 - 22mm; Deep: 8 - 19mm
 Ratchet, Extensions, & Adapter, & U-Joint
 Sale \$387.44 **Tool Club \$309.95**



SKT4147
47pc 1/2" Drive SAE & Metric
 Short: 1/2" - 1-1/8"; 10 - 24mm
 Deep: 1/2" - 15/16"; 10 - 19mm
 Ratchet, 2" & 5" extensions
 Sale \$499.94 **Tool Club \$399.95**



SKT4147-6
47pc 1/2" Drive SAE & Metric
 Short: 1/2" - 1-1/8"; 10 - 24mm
 Deep: 1/2" - 15/16"; 10 - 19mm
 Ratchet, 2" & 5" extensions
 Sale \$499.94 **Tool Club \$399.95**



SKT94549
49pc 3/8" Drive SAE & Metric
 Short: 1/4" - 7/8"; 6 - 19mm
 Deep: 3/8" - 7/8"; 10 - 19mm
 Ratchet, Thumbwheel, U-Joint, & 2 extensions
 Sale \$299.94 **Tool Club \$239.95**



SK 1/4" DRIVE

SK 3/8" DRIVE

SK 1/2" DRIVE

SKT1312
13pc 1/4" Dr. METRIC Deep Set
 Sizes: 4, 5, 5.5, 6, 7, 8, 9, 10, 11, 12, 13, 14 & 15mm
 Sale \$146.88 **Tool Club \$117.50**

SKT1313
13pc 1/4" Dr. METRIC Short Set
 Sizes: 4, 5, 5.5, 6, 7, 8, 9, 10, 11, 12, 13, 14 & 15mm
 Sale \$90.44 **Tool Club \$72.35**

SKT1340
10pc 1/4" Dr. METRIC Short Set
 Sizes: 5, 6, 7, 8, 9, 10, 11, 12, 13 & 14mm.
 Sale \$65.31 **Tool Club \$52.25**

SKT4910
10pc 1/4" Dr. SAE Short Set
 Sizes: 3/16" to 9/16".
 Sale \$62.44 **Tool Club \$49.95**

SKT4911
10pc 1/4" Dr. SAE Deep Set
 Sizes: 3/16" to 9/16".
 Sale \$112.44 **Tool Club \$89.95**

SKT133
13pc 3/8" Dr. METRIC Short Set
 Sizes: 7, - 19mm.
 Sale \$111.19 **Tool Club \$88.95**

SKT89023
13pc 3/8" Dr. 12PT METRIC Short Set
 Sale \$81.19 **Tool Club \$64.95**

SKT1854
14pc 3/8" Dr. METRIC Deep Set
 Sizes: 6 - 19mm.
 Sale \$174.06 **Tool Club \$139.25**

SKT1871
11pc 3/8" Dr. METRIC Deep Set
 Sizes: 9 - 19mm.
 Sale \$139.06 **Tool Club \$111.25**

SKT4613
13pc 3/8" Dr. SAE Short Set
 Sizes: 1/4" to 1".
 Sale \$116.88 **Tool Club \$93.50**

SKT4413
13pc 3/8" Dr. SAE Deep Set
 Sizes: 1/4" to 1".
 Sale \$162.44 **Tool Club \$129.95**

SKT1924
24pc 1/2" Dr. METRIC Short Set
 Sizes: 10 - 32 & 36mm
 Sale \$343.69 **Tool Club \$274.95**

SKT1945
15pc 1/2" Drive Deep METRIC Socket Set
 Sizes: 10 to 24mm
 Sale \$268.69 **Tool Club \$214.95**

SKT1951
21pc 1/2" Dr. METRIC Deep Set
 Sizes: 10 to 28, 30, 32mm.
 Sale \$424.94 **Tool Club \$339.95**

SKT4113-6
13pc 1/2" Dr. SAE Short Set
 Sizes: 7/16" to 1-1/4".
 Sale \$162.44 **Tool Club \$129.95**

Eppy's is an Authorized SK Distributor!
 We stock all Sockets & Wrenches
 with a full LIFETIME WARRANTY!



PROFESSIONAL REVERSIBLE RATCHETS



Completely enclosed ratchet mechanism. Diamond knurled grip.



DOUBLE TOOTH RATCHET



120 tooth ratcheting mechanism

Part #	Drive	Length	Sale	Club
SKT40970	1/4"	4.5"	\$54.38	\$43.50
SKT40971	1/4"	6.5"	\$65.63	\$52.50
SKT45170	3/8"	7.6"	\$68.75	\$55.00
SKT45179	3/8"	10.3"	\$93.69	\$74.95
SKT42470	1/2"	10.3"	\$87.44	\$69.95
SKT40170	1/2"	15"	\$115.63	\$92.50
SKT45174	3/8"	4.8"	\$62.44	\$49.95

Part #	Drive	Sale	Club
SKT800700	1/4"	\$62.44	\$49.95
SKT800720	3/8"	\$78.69	\$62.95
SKT800740	1/2"	\$103.69	\$82.95

LOW PROFILE RATCHET



Part #	Drive	Length	Sale	Club
SKT80180	1/4"	5"	\$70.63	\$56.50
SKT80182	1/4"	12"	\$99.94	\$79.95
SKT80200	3/8"	8"	\$95.63	\$76.50
SKT80202	3/8"	11"	\$106.19	\$84.95
SKT80203	3/8"	15"	\$124.94	\$99.95
SKT80220	1/2"	10"	\$123.69	\$98.95
SKT80221	1/2"	15"	\$156.19	\$124.95
SKT80222	1/2"	24"	\$187.44	\$149.95



- 90 tooth ratcheting mechanism
- Low 4° arc swing for tight spaces
- **Thin, low profile head for tight spaces**
- Quick change forward/reverse lever
- Redesigned ergonomic handle

EXTENDABLE RATCHETS

Features:

- Providing additional reach for tough applications
- Push button quick release design
- Contoured cushion grip handle.



Part #	Drive	Length	Sale	Club
TIT12070	3/8"	8.75" - 12.75"	\$30.63	\$24.50
TIT12073	1/2"	18" - 24"	\$53.13	\$42.50
TIT12072	3/4"	19.5" - 30.5"	\$112.44	\$89.95

ALUMINUM RATCHETS

- 90 TOOTH SEALED HEAD
- 4° SWEEP
- ANODIZED ALUMINUM HANDLE



Part #	Drive	Length	Sale	Club
TIT12160	1/4"	6"	\$34.38	\$27.50
TIT12161	3/8"	12"	\$45.63	\$36.50
TIT12162	1/2"	16"	\$59.38	\$47.50



Part #	Drive	Length	Sale	Club
TIT12167	1/4"	6.5"	\$51.56	\$41.25
TIT12168	3/8"	10"	\$64.38	\$51.50



FLEX HEAD RATCHETS

SKT40972
1/4" Dr. Professional Flex Head Ratchet
Sale \$73.13 **Tool Club \$58.50**
6.3" LONG



SKT80280
1/4" Dr. LP90 Flex Head Teardrop Ratchet - 5"
Sale \$97.44 **Tool Club \$77.95**



SKT45178
3/8" Dr. Professional Stubby Flex Head Ratchet
Sale \$84.38 **Tool Club \$67.50**
5" LONG



SKT80290
3/8" Dr. LP90 Flex Head Teardrop Ratchet - 11"
Sale \$124.94 **Tool Club \$99.95**



SKT3770
3/8" Dr. Professional Bent Flex Head Ratchet
Sale \$91.19 **Tool Club \$72.95**
10.8" LONG



SKT80300
1/2" Dr. LP90 Flex Head Teardrop Ratchet - 15"
Sale \$162.44 **Tool Club \$129.95**



SKT45183
3/8" Dr. Professional Flex Head Ratchet
Sale \$93.69 **Tool Club \$74.95**
10.9" LONG



SKT80310
1/2" Dr. LP90 Teardrop Flex Head Ratchet - 24"
Sale \$186.88 **Tool Club \$149.50**



SKT42472
1/2" Dr. Professional Flex Head Ratchet
Sale \$124.94 **Tool Club \$99.95**
17.6" LONG



TIT11314
1/4" Dr. Swivel Head Micro Ratchet - 4"
90-Tooth reversible. 4° swing arc.
Sale \$26.56 **Tool Club \$21.25**



TIT11315
1/4" Dr. Swivel Head Micro Bit Holder - 4"
90-Tooth reversible. 4° swing arc.
Sale \$26.56 **Tool Club \$21.25**



TIT12175
5pc 90 Tooth Aluminum Ratchet Set
1/4", 3/8", & 1/2" sealed head ratchets.
1/4" & 3/8" flex head ratchets.
Sale \$199.94 **Tool Club \$159.95**



VIMHDR410
Super Long 1/4" Dr. Ratchet
10" Long rubber grip handle 90°. **NEW!**
Sale \$35.63
Tool Club \$28.50



VIMHDR614
Super Long 3/8" Dr. Ratchet
14" Long rubber grip handle 90°. **NEW!**
Sale \$52.81
Tool Club \$42.25



VIMHDR818
Super Long 1/2" Dr. Ratchet
18" Long rubber grip handle 90°. **NEW!**
Sale \$74.94
Tool Club \$59.95



TIT11328
Long 1/4" Dr. Swivel Head
7" Long 250 4° swing arc. **NEW!**
Sale \$27.44
Tool Club \$21.95



SK RATCHETS ARE MADE IN THE USA

RATCHETS

BREAKER BARS

SKT45155
3/8" Dr. Flex Head XXL - 15" Length
Sale \$62.44 **Tool Club \$49.95**



SK MADE IN USA **3/8**

SKT41654
1/2" Dr. Flex Head - 24" Length
Sale \$110.63 **Tool Club \$88.50**



SK MADE IN USA **1/2**

SKT41656
1/2" Dr. Flex Head XXL - 30" Length
Sale \$118.13 **Tool Club \$94.50**



SK MADE IN USA **1/2**

TIT12047
1/2" Dr. Breaker Bar - 30" Length
Sale \$41.88 **Tool Club \$33.50**



TITAN **1/2**

XL BREAKER BARS

TIT12048
3/4" Dr. Breaker Bar - 40" Length
Sale \$92.81 **Tool Club \$74.25**



TITAN **3/4**

TIT12049
1" Dr. Breaker Bar - 40" Length
Sale \$109.38 **Tool Club \$87.50**



TITAN **1"**

RATCHETING BREAKER BARS

Ratcheting swivel heads for tight access



TIT12024
1/2" Dr. Ratcheting - 24" Length
Sale \$52.94 **Tool Club \$42.35**

TITAN **1/2**

RATCHET SETS

KDT81271
2pc 120XP™ Extra Long Handle Ratchet Set
Includes 1/4" & 3/8" ratchets
Sale \$108.69 **Tool Club \$86.95**



KDT81207T
3pc Dual Material Teardrop Ratchet Set
Includes 1/4, 3/8" & 1/2" ratchets.
Sale \$174.94 **Tool Club \$139.95**



KDT81206P
3pc 120XP Ratchet Set
1/4", 3/8", & 1/2" drive.
120 positions for 3° ratcheting arc.
Sale \$162.44 **Tool Club \$129.95**



GEARWRENCH

KDT81298T
3pc Dual Material Locking Flex Head Ratchet Set
Includes 1/4", 3/8" & 1/2" ratchets.
90 Tooth gear with a 4° swing arc.
Sale \$223.13 **Tool Club \$178.50**



NEW!

IRT759991
1/4" Dr. 90T Ratchet w/ Double Injection Handle
90 Tooth precision machined gears.
4° swing angle. Sealed head for increased durability. Ergonomic comfort grip handle.
Sale \$31.24 **Tool Club \$24.99**



NEW! **IR**

IRT759992
3/8" Dr. 90T Ratchet w/ Double Injection Handle
90 Tooth precision machined gears.
4° swing angle. Sealed head for increased durability. Ergonomic comfort grip handle.
Sale \$42.44 **Tool Club \$33.95**



NEW! **IR**

IRT759993
1/2" Dr. 90T Ratchet w/ Double Injection Handle
90 Tooth precision machined gears.
4° swing angle. Sealed head for increased durability. Ergonomic comfort grip handle.
Sale \$53.74 **Tool Club \$42.99**



NEW! **IR**

IRT752026
3pc 90 Tooth Ratchet Master Set
Sizes: 1/4" Drive, 3/8" Drive & 1/2" Drive.
90 Tooth precision machined gears.
4° swing angle. Sealed head for increased durability. Ergonomic comfort grip handle.
Includes brushed aluminum accented EVA organization tray.
Sale \$124.94 **Tool Club \$99.95**



NEW! **IR**

KDT81223
2pc 72-Tooth Dual Material Roto Ratchet Set
Includes 1/4" & 3/8" ratchets.
270° rotating head & 5° swing arc.
Sale \$93.69 **Tool Club \$74.95**



KDT81204T
2pc Dual Material Flex Head Ratchet Set
Includes 1/4" & 3/8" ratchets.
6 position flex head & 4° ratcheting arc
Sale \$131.19 **Tool Club \$104.95**



KDT81203T
3pc Dual Material Ratchet Set
Includes (1) 1/4" & (1) 3/8" ratchets & (1) 3/8" flex ratchet.
Sale \$177.44 **Tool Club \$141.95**



KDT81230P
4pc 120XP Flex Head Ratchet Set
Includes 1/4", 3/8", & 1/2" ratchets.
6 position flex head and 3° ratcheting arc.
Sale \$233.13 **Tool Club \$186.50**



RATCHETS

TIT12045
3/8" Dr. X-Long Offset Ratchet
10.5" long.
Sale \$28.44 **Tool Club \$22.75**



TITAN **3/8**

TIT12046
1/2" Dr. X-Long Offset Ratchet
13.25" long.
Sale \$32.44 **Tool Club \$25.95**



TITAN **1/2**

GEARWRENCH

Features:

- 3° Ratcheting Arc
- 6 Position Flex Head
- Enclosed Head Design for Extreme Resistance to Dirt Infiltration

NEW!



Part #	Drive	Length	Sale	Club
KDT81011P	1/4"	5"	\$39.38	\$31.50
KDT81212T	3/8"	5"	\$58.69	\$46.95
KDT81211T	3/8"	8"	\$51.88	\$41.50
KDT81211P	3/8"	8-1/4"	\$71.56	\$57.25
KDT81304P	1/2"	11"	\$78.13	\$62.50

120XP™ FLEX HEAD TEARDROP RATCHETS



Part #	Drive	Length	Sale	Club
KDT81012P	1/4"	6"	\$44.69	\$35.75
KDT81215P	3/8"	11"	\$74.94	\$59.95
KDT81306P	1/2"	17"	\$88.69	\$70.95

EXTRA LONG HANDLE TEARDROP RATCHETS

Features:

- 3° Ratcheting Arc
- Extra-Long Handle for Hard-to-Reach Spots
- 120XP™ Ratchet Head
- Flush-Mounted Forward/Reverse Lever

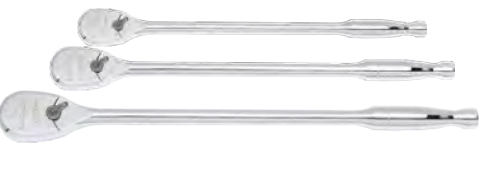

Part #	Drive	Length	Sale	Club
KDT81034	1/4"	9"	\$47.81	\$38.25
KDT81269	3/8"	18"	\$80.44	\$64.35
KDT81364	1/2"	24"	\$116.19	\$92.95



Features: Patented 120XP Head, Formed Low Profile Tubing, HD Scale in SAE & Metric, & Case

Part #	Drive	Range	Sale	Club
KDT85171	1/4"	30-200 in/lbs.	\$212.44	\$169.95
KDT85176	3/8"	10-100 ft/lbs.	\$224.94	\$179.95
KDT85181	1/2"	30-250 ft/lbs.	\$281.19	\$224.95
KDT85065	3/4"	100-600 ft/lbs.	\$862.44	\$689.95



Features: Quick release socket retention. Knurled metal handle. Easy to read dual scale. Positive lock collar.

Part #	Drive	Range	Sale	Club
SKT77002	1/4"	20-150 in/lbs.	\$312.44	\$249.95
SKT77025	3/8"	30-250 in/lbs.	\$249.94	\$199.95
SKT77100	3/8"	10-100 ft/lbs.	\$249.94	\$199.95
SKT77150	1/2"	20-120 ft/lbs.	\$274.94	\$219.95
SKT77250	1/2"	30-250 ft/lbs.	\$287.44	\$229.95
SKT77600	3/4"	100-600 ft/lbs.	\$999.94	\$799.95

FLEX HEAD TORQUE WRENCHES



Features: Torque-setting adjustment requires only fingertip force. No need to wind down after use.

Part #	Drive	Range	Sale	Club
PREC2FR100F	3/8"	20-100 ft/lbs.	\$237.44	\$189.95
PREC3FR250F	1/2"	40-250 ft/lbs.	\$299.94	\$239.95

E-SPEC TORQUE WRENCHES



Features: 100 available preset torque settings, simple 2 button menu w/ reversible screen, includes rechargeable Li-ion Battery & AAA Battery Cartridge

Part #	Drive	Range	Sale	Club
KDT85235	1/4"	5 - 25Nm	\$687.44	\$549.95
KDT85237	3/8"	20 - 100Nm	\$687.44	\$549.95
KDT85238	1/2"	68 - 340Nm	\$749.94	\$599.95

HD ELECTRONIC TORQUE WRENCHES



Features: "Target Torque Alert" gives a warning as you approach your target torque, 24 Tooth Head.

Part #	Drive	Range	Sale	Club
KDT85082	3/4"	70 - 750 ft/lbs.	\$1,499.94	\$1,199.95
KDT85085	1"	150 - 1,000 ft/lbs.	\$1,749.94	\$1,399.95



Features: Patented 120XP 15° Flex Head, Formed Low Profile Tubing, Vibrating handle, buzzer, and LCD screen alert when target torque is reached. Digital Scale in ft-lb, in-lb, Nm, Kg-m, and Kg-cm, & Case

Part #	Drive	Range	Sale	Club
KDT85194	1/4"	2-20 ft/lbs.	\$305.63	\$244.50
KDT85195	3/8"	10-100 ft/lbs.	\$318.69	\$254.95
KDT85196	1/2"	25-250 ft/lbs.	\$362.44	\$289.95



AFF41055
1" Ratcheting Torque Wrench
Range: 100 - 700 ft/lbs. 48" long. Perceptible jolt & audible click.
Sale \$837.44 **Tool Club \$669.95**

TORQUE MULTIPLIERS

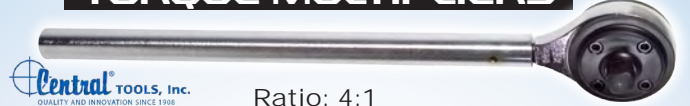

Ratio: 4:1
Increases the altitude of your wrench by torque. Designed with four pinion gears in a compact housing.

CEN6380
22" Torque Multiplier - 1,000 Ft. Lbs.
Input: 1/2" Drive; Output: 3/4" Drive
Sale \$563.13 **Tool Club \$450.50**

CEN6387
25" Torque Multiplier - 2,000 Ft. Lbs.
Input: 3/4" Drive; Output: 1" Drive
Sale \$722.44 **Tool Club \$577.95**

KTA34688
5:1 Torque Multiplier
Accuracy better than ±5%
Input: 3/4" Drive; Output: 1" Drive.
Reaction bar supplied in two styles for maximum versatility.
Sale \$662.44 **Tool Club \$529.95**



AST78810
10pc 1/2" Drive Torque Aluminum Extension Set
8" Extensions Sizes: 65, 75, 80, 90, 100, 110, 120, 130, 140 & 150ft/lbs.
Sale \$118.13 **Tool Club \$94.50**



AST78818
8pc Torque Limiting Extension Socket Set With Impact Sockets
4 Torque Limiting Extensions: 90 100 110 and 120ft/lbs
4 Protective Lug Nut Impact Sockets: 17mm, 19mm, 21mm, and 7/8", 1/2" Dr.
Sale \$106.18 **Tool Club \$84.95**



LIS28100
Torque Angle Meter
Use with 1/2" drive to tighten head bolts and other bolts where a torque angle is required.
Sale \$54.06 **Tool Club \$43.25**



1/4" DRIVE EXTENSIONS SETS

3/8" DRIVE EXTENSIONS SETS

1/2" DRIVE EXTENSIONS SETS

SKT4916T
6pc 1/4" Dr. SuperKrome® Extension Set
Sizes: 2", 3", 6", 8", 10" & 14"
Sale \$96.19 **Tool Club \$76.95**







SKT4514
4pc 3/8" Dr. Extension Set
Sizes: 1-1/2", 3", 6" & 12"
Sale \$74.38 **Tool Club \$59.50**







SKT4114
3pc 1/2" Dr. Extension Set
Sizes: 5", 10" & 20"
Sale \$95.63 **Tool Club \$76.50**

SKT40936
6pc 1/4" Dr. SuperKrome® Wobble Extension Set
Sizes: 1-1/2", 2", 4", 6", 10" & 14"
Sale \$104.38 **Tool Club \$83.50**





SKT4524
4pc 3/8" Dr. Wobble Extension Set
Sizes: 3", 6", 8" & 12"
Sale \$87.44 **Tool Club \$69.95**





SKT40165
5pc 1/2" Dr. Extension Set
Sizes: 2", 3", 5", 10" & 15"
Sale \$118.69 **Tool Club \$94.95**





SKT4941
3pc 1/4" Dr. SuperKrome® Locking Extension Set
Sizes: 3", 7" & 15"
Sale \$131.19 **Tool Club \$104.95**





SKT4538
8pc 3/8" Dr. Extension Set
Sizes: 1-1/2", 3", 4", 6", 8", 10", 18" & 24"
Sale \$174.94 **Tool Club \$139.95**





SKT40208
5pc 1/2" Dr. Wobble Extension Set
Sizes: 2", 3", 5", 10" & 15"
Sale \$143.69 **Tool Club \$114.95**





TIT66940
3pc 1/4" Dr. Extension Set
Sizes: 2", 4" & 6"
Sale \$12.44 **Tool Club \$9.95**





SKT4516
3pc 3/8" Dr. Locking Extension Set
Sizes: 7-1/2", 13-1/2" & 19-1/2"
Sale \$174.94 **Tool Club \$139.95**





TIT12081
3pc 1/2" Dr. Extra Long Extension Bar Set
Sizes: 18", 24" & 30" for increased access.
Sale \$31.19 **Tool Club \$24.95**





VIMDSE46
1/4" Dr. 6" Dual Swivel Extension
6" Long With Locking Square Drive.
Made from durable rust-resistant material for long-lasting performance.
Sale \$37.44 **Tool Club \$29.95**





TITAN



TITAN



VIMMEK400
7 Piece 1/4" Drive Master Extension Kit
2 Step wobble extension 8 inch locking, 6 inch spring loaded dual swivel extension, spring loaded, universal joint adapter. Set includes a 3 inch, 6 inch, 8 inch & 10 inch.
Sale \$87.44 **Tool Club \$69.95**





TIT68152
4pc 3/8" Dr. Extension Set
Sizes: 1-3/4", 3", 6" & 8"
Sale \$17.19 **Tool Club \$13.75**





TIT62140
3pc 1/2" Dr. Extension Set
Sizes: 3", 5" & 8"
Sale \$21.19 **Tool Club \$16.95**





VIMDSE68
3/8" Dr. 8" Dual Swivel Extension
8" Long With Locking Square Drive.
Made from durable rust-resistant material for long-lasting performance.
Sale \$46.19 **Tool Club \$36.95**





TITAN

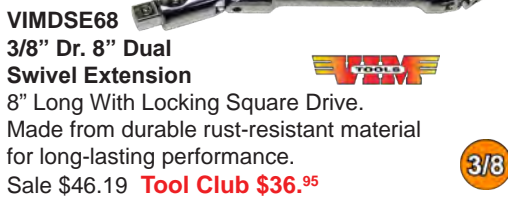

TITAN



BIT EXTENSIONS SETS

TIT12082
3pc Socket Adapters
Sale \$6.56 **Tool Club \$5.25**



TIT15206
3pc X-Long Socket Adapters - 12"
Sale \$24.38 **Tool Club \$19.50**

TIT62141
3pc 1/2" Dr. Wobble Set
Sizes: 3", 5" & 8"
Sale \$24.94 **Tool Club \$19.95**





TIT15214
3pc 6" Locking Socket Adapter Set
1/4", 3/8" & 1/2" drive
Sale \$28.69 **Tool Club \$22.95**



TIT12089
9pc Impact Socket Adapter Set
Sizes - 1/4" Dr.: 2-1/2", 6" & 12"; 3/8" Dr.: 2-1/2", 6" & 12"; 1/2" Dr.: 2-3/4", 6" & 12".
Sale \$39.69 **Tool Club \$19.50**



VIMDSE812
1/2" Dr. 12" Dual Swivel Extension
12" Long With Locking Square Drive.
Made from durable rust-resistant material for long-lasting performance.
Sale \$49.94 **Tool Club \$39.95**





CALIPERS

CEN3M430A
Electronic Digital Rotor
Gauge: 0 - 5.6"
Sale \$83.69
Tool Club \$66.95

CEN3B351
Electronic
Brake Drum Micrometer:
6-20.65" Range
.0005" Graduations
Sale \$262.44
Tool Club \$209.95

CEN6420
Caliper:
0 - 6"
.001"/.02mm graduations.
Sale \$122.44
Tool Club \$97.95

CEN3C351
Carbon Fiber Digital
Caliper with Fractional Display
Range: 0-6"/0-150mm; Inch, Metric and
Fractional reading.
Sale \$24.38 **Tool Club \$19.50**



CEN3M336
STORM™ Wheels On Rotor Gage
Low profile to check rotors with wheel on.
Interchangeable pointed/flat anvil,
Sale \$131.19 **Tool Club \$104.95**

CEN3D302
Cylinder Bore
Gauge: 2" - 6"
Sale \$183.69
Tool Club \$146.95

CEN3D102
Dial Indicator Set with
On/Off Magnetic Base
Measures 0" to 1"
graduations. Flex-arm.
Sale \$144.38
Tool Club \$115.50

CEN3D105
Dial Indicator Set with
On/Off Magnetic Base
Measures 0" to 1"
in .001" graduations.
Sale \$188.13
Tool Club \$150.50

CEN3D103
Rotor Runout/
Ball Joint Gauge Set
Includes: Dial indicator,
locking plier clamp with
adjustable flex-arm.
Sale \$115.63
Tool Club \$92.50

MICROMETERS

CEN3M314
4pc Digital Micrometer Set
Easy to readout large digital display. Carbide
measuring faces. Includes calibration
standards. Complete in plastic case. Set
covers from zero to 4".
Sale \$499.94 **Tool Club \$399.95**



CEN3M116
Conventional Micrometer 6pc Set: 0-6"
Sale \$351.88 **Tool Club \$281.50**



Part #	Range	Sale	Club
CEN3M101	0 - 1"	\$53.13	\$42.50
CEN3M102	1" - 2"	\$54.38	\$43.50
CEN3M104	3" - 4"	\$75.31	\$60.25
CEN3M105	4" - 5"	\$79.06	\$63.25

CEN3M114
3pc Micrometer Set
Includes:
0 - 1" micrometer,
1" - 2" micrometer,
2" - 3" micrometer.
Sale \$220.31
Tool Club \$176.25



CEN3M130
Disc Brake Micrometer:
0.3" - 1.3"
Sale \$101.19
Tool Club \$80.95



CEN3S116
Telescoping Gauge Set
Sizes: 5/16" - 6"
Sale \$46.19
Tool Club \$36.95



STRAIGHT EDGES



Part #	Length	Sale	Club
CEN6475	18"	\$119.38	\$95.50
CEN6429	24"	\$129.94	\$103.95
CEN6431	35"	\$158.69	\$126.95

NEW SOCKET SETS

NEW!
CTA3805
10pc 10mm Socket Set
5 most popular styles of 10mm socket sin
1/4" & 3/8" Dr. Includes stubby, standard,
deep, flex, & magnetic impact sockets.
Sale \$37.44 **Tool Club \$29.95**



KDT81394 **GW GEARWRENCH**
12pc 1/4"Dr. 6 Point Stubby Socket Set **Metric**
Ultra shallow height 4mm, 5mm, 6mm, 7mm, 8mm,
9mm, 10mm, 11mm, 12mm, 13mm, 14mm, 15mm
design. Sale \$45.63 **Tool Club \$36.50**



KDT81395 **GW GEARWRENCH**
10pc 1/4"Dr. 6 Point Stubby Socket Set **SAE**
Ultra shallow height design. 3/16", 7/32", 1/4",
9/32", 5/16", 11/32", 3/8", 7/16", 1/2", 9/16"
Sale \$41.88 **Tool Club \$33.50**



KDT81396 **GW GEARWRENCH**
14Pc. 3/8" Dr. 6pt **Metric** Stubby Socket Set
Ultra shallow height design 6mm, 7mm, 8mm,
9mm, 10mm, 11mm, 12mm, 13mm, 14mm,
15mm, 17mm, 18mm, 19mm.
Sale \$74.38 **Tool Club \$59.50**



KDT81397 **GW GEARWRENCH**
10pc 10mm Socket Set
Ultra shallow height design.
1/4", 5/16", 3/8", 7/16", 1/2", 9/16", 5/8", 11/16",
3/4", 13/16", 7/8", 15/16", 1"
Sale \$74.69 **Tool Club \$59.75**



NEW RATCHETS

KDT81055 **GW GEARWRENCH**
1/4" Drive 120XP Dual Material Handle Locking
Flex Head Ratchet 9"
9 position push button locking flex head design.
Sale \$74.94 **Tool Club \$59.95**



KDT81321 **GW GEARWRENCH**
3/8" Drive 120XP Dual Material Handle Locking
Flex Head Ratchet 15.5"
9 position push button locking flex head design.
Sale \$112.44 **Tool Club \$89.95**



KDT81375 **GW GEARWRENCH**
1/2" Drive 120XP Dual Material Handle Locking
Flex Head Ratchet 19"
9 position push button locking flex head design.
Sale \$124.94 **Tool Club \$99.95**





VIMFRBS89
89pc Bit Set with 1/4" Flex Ratchet
 Set includes a wide array of popular bits: metric & SAE hex, Phillips, ACR, slotted, triple square (XZN), TORX®, TORX® Plus, TORX® tamper resistant, TORX® Plus tamper resistant, MORTORQ, square (Robertson) & clutch.
 Sale \$141.19 **Tool Club \$112.95**



VIMVHC77
77pc Half Cut Stubby Bit Set
 Includes: 5/8" Bits For Torx, Torx Plus, Tamper Proof Torx, Triple Square, 5 Pt. Tamper Proof, SAE & Metric Hex, Flathead & Phillips.
 Sale \$137.44 **Tool Club \$109.95**

CTA1220
16pc 5PT EPR Torx Socket Set
 Sizes: 6, 7, 8, 10, 11, 12, 14, 16, 18, 20, 22, 24, 26, 28, 30 & 32 ERP.
 Sale \$119.38 **Tool Club \$95.50**

CTA3038
10pc 12PT XZN Socket Set
 Sizes: 4mm - 18mm
 Sale \$37.44
Tool Club \$29.95

CTA9025
4pc XZN "L" Wrench Set
 Sizes: 10, 12, 14 & 16mm
 Sale \$43.13 **Tool Club \$34.50**

VIMTX100XI
6pc XL Torx Screwdriver Set
 Sale \$62.44 **Tool Club \$49.95**



VIMIRS100
39Pc Interchangeable Ratcheting Screwdriver set.
 Sale \$90.63 **Tool Club \$72.50**



VIMHMS26
26pc SAE & METRIC Master Hex Socket Bit Set
METRIC: 2 - 19mm, **SAE:** 3/32" - 3/4"
 Sale \$106.19 **Tool Club \$84.95**



VIMTMS34PF
34pc Master Torx Set
 Torx sizes: T8 to T60
 Female Torx: E4 to E20
 Tamperproof: T10 to T55
 Sale \$121.19 **Tool Club \$96.95**

VIMV458LSET
18pc X-Long Torx Set
 Sizes: T10, T15, T20, T25, T27, T30, T40, T45 & T50.
 Each size comes 4.5" and 8" long.
 Sale \$124.94 **Tool Club \$99.95**

VIMVDE418
11pc "E" Torx Set
 Sizes: E4, E5, E6, E7, E8, E10, E11, E12, E14, E16 & E18 deep sockets.
 Sale \$53.69 **Tool Club \$42.95**

VIMMMS450
50pc 1/4" Dr. Mechanics Master Set Hex Drivers
 5/64" - 3/8"
 Hex Drivers 2mm - 10mm, P1 & P2 phillips drivers, 1/4" & 3/8" Blade drivers, XZN drivers XZN4 through XZN12, TORX PLUS drivers IP15 through IP50, TORX drivers T8 - T50
 Sale \$149.94 **Tool Club \$119.95**

VIMIMP600K
Reversible 3/8" Dr. Impact Driver & 6 Impact Bit Sets
 Includes 8pc Impact Hex, 8pc Torx Impact, 8pc 5/16" Shank Impact Hex, 8pc 5/16" Shank Hex Metric, 8pc Triple Square & 8pc Torx Plus.
 Sale \$124.94 **Tool Club \$99.95**

NEW!
VIMXZN100A
13pc Triple Square
 4,5,6,7,8,9,10,11, 12,13,14,16h,18h
 Foam Tray
 Sale \$69.38 **Tool Club \$55.50**



VIMXZN400A
13pc X-Long Triple Square Bits
 Sizes: 4, 5, 6, 7, 8,9,10,11,12,13, 14, 16 & 18mm. 4" long
 Sale \$99.94 **Tool Club \$79.95**



VIMHCT1050-03
10pc Stubby Torx Set
 Sizes: T10, T15, T20, T25, T27, T30, T40, T45, T47 & T50. Only 3/4" long.
 Sale \$41.19 **Tool Club \$32.95**



NEW!
VIMTORXTBS
Torx Truck Bed Set
 T40, T45, T50 & T55 IP45, IP50 & IP55 TORX PLUS SOCKET EP24
 Sale \$39.94 **Tool Club \$31.95**



VIMDD2
1/4" Dual Drive Micro Ratchet
 Removable 1/4" square drive & 1/4" offset square in handle. Thumb wheel for finger tip control in tight areas. 60° fine tooth ratchet for high torque applications.
 Sale \$37.44 **Tool Club \$29.95**



VIMDD3
3/8" Dual Drive Micro Ratchet
 Removable 3/8" square drive & 3/8" offset square in handle. Thumb wheel for finger tip control in tight areas. 60° fine tooth ratchet for high torque applications.
 Sale \$41.19 **Tool Club \$32.95**



VIMHXL100
14pc SAE Long Hex Driver Set
 Ball Hex Sizes: 1/8" - 3/8"
 Hex Sizes: 1/8" - 3/8"
 Sale \$91.56
Tool Club \$73.25



NEW!
VIMHXL100
14pc Metric Long Hex Driver Set
 Ball Hex Sizes: 3mm - 8mm & 10mm
 Hex Sizes: 3mm - 8mm & 10mm
 Sale \$87.44
Tool Club \$69.95





TIT16122
13pc Torx Bit Set
 Sizes: T10, T15, T20, T25, T27, T30, T40, T45, T47, T50, T55, T60 & T70.
 Sale \$46.88 **Tool Club \$37.50**



TIT16121
12pc Tamperproof Torx Bit Set
 1/4" Drive: T10 - T30;
 3/8" Drive: T40 - T60
 Sale \$45.63 **Tool Club \$36.50**



TIT17403
13pc E Torx Socket Set
 E4, E5, E6, E7, E8, E10, E12, E14, E16, E18, E20, E22, E24.
 Sale \$55.63 **Tool Club \$44.50**

TIT16123
13pc SAE Hex Bit Socket Set
 5/64", 3/32", 7/64", 1/8", 9/64", 5/32", 3/16", 7/32", 1/4", 5/16", 3/8", 7/16", 1/2"
 Sale \$46.88 **Tool Club \$37.50**



TIT16130
6pc 1/2" Dr SAE Hex Bit Socket Set
 Sizes: 9/16", 5/8", 11/16", 3/4", 13/16" & 7/8"
 Sale \$53.13 **Tool Club \$42.50**



TIT16124
13pc METRIC Hex Bit Socket Set
 2, 2.5, 3, 4, 5, 5.5, 6, 7, 8, 9, 10, 11, 13mm
 Sale \$46.88 **Tool Club \$37.50**



TIT16131
7pc METRIC Hex Set
 Sizes: 13, 14, 15, 17, 19, 21 & 22mm.
 All 1/2" Drive.
 Sale \$55.63 **Tool Club \$44.50**



TIT16132
8pc SAE/Metric Large Hex Bit Socket Set
 Sizes: 9/16" - 3/4" & 14mm - 19mm.
 1/2" Drive. Includes magnetic socket rail.
 Sale \$55.63 **Tool Club \$44.50**





TIT16144
9pc Triple Square Set
 M4, M5, M6, M8, M10, M12, M14, M16, M18
 Sale \$41.88 **Tool Club \$33.50**





TIT68965
3/8" Dr. Mortorq Socket Set
 Sizes: MST-0, MST-1, MST-2, MST-3, & MST-4
 Sale \$29.94 **Tool Club \$23.95**



TIT12768
8pc SAE T-Handle Hex Key Set
 Sizes: 3/32", 7/64", 1/8", 9/64", 5/32", 3/16", 7/32", & 1/4".
 Sale \$19.06 **Tool Club \$15.25**



TIT12769
6pc METRIC T-Handle Hex Key Set
 Sizes: 2, 2.5, 3, 4, 5, & 6mm.
 6" long handles.
 Sale \$18.69 **Tool Club \$14.95**

TIT12734
10pc Tamper-Proof 5 PT Torx Key Set
 Sizes: T6, T7, T8, T9, T10, T15, T20, T25, T27, T30, T40, T45 & T50
 Sale \$33.69 **Tool Club \$26.95**



TIT12715
13pc Tamperproof Torx Set
 Sizes: T6, T7, T8, T9, T10, T15, T20, T25, T27, T30, T40, T45 & T50.
 Sale \$39.69 **Tool Club \$31.75**

TIT12713
13pc Long SAE Ball Hex Set
 Sizes: 0.05", 1/16", 5/64", 3/32", 7/64", 1/8", 9/64", 5/32", 3/16", 7/32", 1/4", 5/16" & 3/8"
 Sale \$33.69 **Tool Club \$26.95**



TIT12714
9pc Long METRIC Ball Hex Set
 Sizes: 1.5, 2, 2.5, 3, 4, 5, 6, 8, 9 & 10mm
 Sale \$29.38 **Tool Club \$23.50**



TIT12733
8pc Triple Square L-Wrench Set
 Sizes: M3, M4, M5, M6, M8, M9, M10, M12.
ONLY SET WITH M9!
 Sale \$33.69 **Tool Club \$26.95**



TIT54137
43pc Master Torx Bit Socket Set
 E Torx: E4 - E24
 Torx: T10 - T70
 Tamperproof Torx: T10 - T60
 Torx Bits: T4 - T9
 Blow molded case.
 Sale \$68.13 **Tool Club \$54.50**





TIT17209
7pc Tamperproof Torx Screwdriver Set
 Sizes: T8, T10, T15, T20, T25, T27, T30.
 Sale: \$41.88 **Tool Club \$33.50**



WILW80287
3pc Folding Key Set
 SAE sizes: 1/16 - 5/16-Inch
 Metric sizes: 1.5 - 8 mm
 Star sizes: T9- T40
 Sale \$21.19 **Tool Club \$16.95**





KDT83505
26pc Long Ball End Hex Key Set
 SAE sizes: .05 - 3/8-Inch
 Metric sizes: 1.5 - 10 mm
 Sale \$31.19 **Tool Club \$24.95**



KDT86538
80pc Master Bit Socket Set
 • 12 SAE Hex Bit Sockets
 • 12 Metric Hex Bit Sockets
 • 7 Ball End Hex Bit Sockets
 • 13 Torx Bit Sockets
 • 10 Long Torx Bit Sockets
 • 13 Tamper Proof Torx Bit Sockets
 • 13 External Torx Bit Sockets
 Sale \$218.69 **Tool Club \$174.95**









CTA9650L
8pc External Torx Plus® Socket Set
 Sizes: EP6 - EP18. New design services elliptical-shaped fasteners now found on many vehicle applications. Black finish & impact quality.
 Sale \$43.13 **Tool Club \$34.50**



CTA5420
15 Pc. EP Torx Plus Socket Set
 Sizes: EP6 - EP32.
 Services elliptical-shaped Torx Plus® fasteners found on many vehicles
 Sale \$112.44 **Tool Club \$89.95**



KDT9224D
4pc Ratcheting Female Torx Set
 Sizes: E6 - E24.
 Sale \$131.19
Tool Club \$104.95



SUN2690S
8pc Torx Impact Socket Set
 1/2" drive.
 Sizes: T30, T40, T45, T47, T50, T55, T60, T70.
 Sale \$53.44
Tool Club \$42.75



SUN3841
11pc 3/8" Dr. Pipe Plug Socket Set
 Internal: 3/16", 1/4", 9/32", 5/16", 11/32" & 3/8"
 External: 1/4", 9/32", 5/16", 11/32" & 3/8"
 Sale \$86.56
Tool Club \$69.25



KDT80726
36pc Master Hex, Torx & E-Torx Set
 Torx: T10 - T55,
 Hex: 2mm - 10mm,
 5/32" - 3/8" & E-Torx: E5 - E18
 Sale \$222.44 **Tool Club \$177.95**



SUN2690SE
9pc E-Torx Impact Socket Set
 1/2" drive.
 Sizes: E10, E11, E12, E14, E16, E18, E20, E22, E24.
 Sale \$57.81
Tool Club \$46.25



SUN2639L
10pc METRIC Hex Impact Set
 6" Long
 Sizes: 6, 7, 8, 10, 12, 14, 15, 17, 18, & 19mm.
 Sale \$123.69
Tool Club \$98.95



KDT80742
84pc Master Bit Set
 Includes: 1/4", 3/8", & 1/2" Standard and Long Hex, Ball End Hex, Tamper-proof Torx, E-Torx, & Torx. SAE & Metric Hex sizes.
 Sale \$237.44 **Tool Club \$189.95**



SUN2637
20pc 1/2" Dr. SAE & METRIC Master Impact Hex Driver Set
 Sizes: 1/4", 5/16", 3/8", 7/16", 1/2", 9/16", 5/8", 11/16", 3/4", 9/32", 6, 7, 8, 10, 12, 14, 15, 17 - 19mm.
 Sale \$156.69
Tool Club \$125.35



SUN2638L
10pc SAE Hex Impact Set
 6" Long
 Sizes: 1/4", 9/16", 5/16", 3/8", 7/16", 3/4", 11/16", 5/8", 9/16", & 1/2".
 Sale \$125.00
Tool Club \$100.00



SUN2637L
20pc 1/2" Dr. SAE & METRIC Master Impact X-Long Hex Driver Set
 6" long.
 Sizes: 1/4" - 1/2". 6 - 19mm.
 Includes carrying case.
 Sale \$230.94
Tool Club \$184.75



SUN2639
10pc METRIC Hex Driver Set
 Sizes: 6, 7, 8, 10, 12, 14, 15, 17, 18 & 19mm
 Sale \$82.44
Tool Club \$65.95



SUN2638
10pc SAE Impact Hex Driver Set
 Sizes: 1/4", 9/32", 5/16", 3/8", 7/16", 1/2", 9/16", 5/8", 11/16" & 3/4"
 Sale \$93.13
Tool Club \$74.50



SUN4507
5pc METRIC Impact Hex Set
 Large Sizes: 14, 17, 19, 22 & 24mm
 Sale \$119.94
Tool Club \$95.95



SUN4506
5pc SAE Impact Hex Set
 Large Sizes:
 3/4", 7/8", 1", 1-1/8" & 1-1/4"
 Sale \$119.94
Tool Club \$95.95



SUN9921
14pc Long METRIC Ball Hex & Hex Bit Set
 Sizes: 3, 4, 5, 6, 7, 8 & 10mm
 Sale \$86.56 **Tool Club \$69.25**



WILW54287
15pc Drain Plug Socket Set
 Sizes: (Hex) 9, 10, 12, 14 and 17mm; (Square) 7, 8, 11, 13mm, 5/16", 3/8"; (Female Square) 10mm; (Male Triangle) 10mm, (Tamper-proof Triple Square) 16mm
 Sale \$42.44 **Tool Club \$33.95**



SUNEX TOOLS
SUN3569
84pc 3/8" Dr. Master Impact Bit Set
 Hex Bits: SAE & Metric stubby, regular, long.
 Torx Bits: T20 - T55
 E-Torx: E5 - E15
Tamperproof Torx: T10 - T50
Triple Square: M4 - M16
 Sale \$262.44 **Tool Club \$209.95**

12 PT AXLE SOCKETS

SUN2835
8pc 12pt Spindle Nut Socket Set
Sizes: 29, 30, 32, 34, 35, 36, 38 & 39mm.
Sale \$173.13



SUN2837
4pc Set
Sizes: 30, 32, 34 & 36mm.
Sale \$105.63



Part #	Size	Sale	Club
LIS39510	30mm	\$23.13	\$18.50
SUN230ZMD	30mm	\$17.44	\$13.95
SUN232ZMD	32mm	\$18.69	\$14.95
SUN234ZMD	34mm	\$20.63	\$16.50
SUN2802ZD	36mm	\$34.06	\$27.25
LIS39650	39mm	\$24.38	\$19.50

CTAA433
46mm 1/2" Dr. Front Wheel Bearing Retaining Nut Socket
For BMW E24, E28, E32, & E34, & Audi & VW Type 2.
Sale \$32.19 **Tool Club \$25.75**



CTA4146
BMW Front Wheel Hub Bearing Nut Socket
46mm x 12 PT x 3/4" drive.
Sale \$37.44 **Tool Club \$29.95**



LUG NUT FLIP SOCKET



Part #	Size	Sale	Club
CTA4221	18.5 x 19.5mm	\$19.06	\$15.25
CTA1799	21 x 21.5mm	\$17.81	\$14.25
CTA4222	22 x 22.5mm	\$19.94	\$15.95

CTA4218
Mercedes Lug Nut Socket
17mm x 6 PT "Flower Design". '09 and up. Plastic sleeve protects rims.
Sale \$27.19 **Tool Club \$21.75**



SUN2714
17mm Covex Extra Thin Mercedes Wheel Lug Socket
For flower head design on late model Mercedes S, GLK, and CL class.
Sale \$25.94 **Tool Club \$20.75**



CTA7307
7pc Flip Socket Set
Sizes: 17mm x 17.5mm, 18.5mm x 19.5mm, 19mm x 21mm, 21mm x 21.5mm, 22mm x 22.5mm, 27mm x 27.7mm, 1/2" Dr. Ext.
Sale \$99.94 **Tool Club \$79.95**



AST7870
7pc Chrome Protective Plastic Sleeve Socket Set
Sizes Include: 13/16", 7/8", 1", 1-1/16", 17mm, 19mm, 21mm. Hollow design creates room for removing longer bolts by pushing out plastic insert
Sale \$71.88 **Tool Club \$57.50**



BUDD WHEEL

SUN4626
3/4" Dr. Combination Budd Wheel Set
41 x 21mm (4121C), 33mm Deep Impact Socket (433MD), 35 x 17mm Budd Wheel (43517B), 1-1/2 x 13/16" Budd Wheel
Sale \$149.94 **Tool Club \$119.95**



SUN5626
1" Dr. Budd Wheel Set
1-1/2" x 13/16", 35mm x 17mm, 38mm x 20mm, 41mm x 21mm, & deep 33mm socket.
Sale \$201.88



6 PT AXLE SOCKETS

SUN2839
7pc Spindle Nut Set
Sizes: 29, 30, 32, 34-36 & 38mm.
Sales Price \$127.19
Tool Club \$101.75



AME67301
Nut Buddy Junior
Rated output torque: 885 ft/lbs. Includes sockets (17, 19, 21mm).
Sale \$131.19 **Tool Club \$104.95**



AME67300
Nut Buddy Lugnut Buster
Busts loose stubborn lugnuts. Rated output torque: 2,950 ft/lbs. Includes two sockets (1-1/2" & 1-5/16") and extension.
Sale \$174.94 **Tool Club \$139.95**



WHEEL LOCK REMOVER

CAL75510
16pc Wheel Lock Master Key Set
Reduces chances of damaging lug nuts
Designed for removing many OEM & aftermarket specific locking wheel lug nuts.
Sale \$109.38 **Tool Club \$87.50**



AME67800
3pc Spline Plus "Six-Way" Socket Set
Sizes: 17mm, 19mm & 21mm. Works on at least 6 different fastener types.
Sale \$49.94 **Tool Club \$39.95**



AME68025
3pc SUV & Light Truck Spline Plus Socket Set
Sizes: 22mm, 7/8" & 15/16". 1/2" drive impact rated. Color coded protective sleeves. Works on at least 6 different fastener types.
Sale \$76.88 **Tool Club \$61.50**



SUN5690A
10pc SAE & METRIC
Deep: 33mm, 1", 1-3/16" & 1-3/4"; Thin wall deep: 1-1/16", 1-1/8" & 1-1/4"; Square: 13/16" & 15/16"; Controlled depth: 1-1/2".
Sale \$254.06 **Tool Club \$203.25**



SUN433MXL
3/4" Dr. 33mm X-Long Socket - 9" Long
Sale \$70.00 **Tool Club \$56.00**



SUN533MEL
1" Dr. 33mm X-Long Socket - 10" Long
Sale \$118.13 **Tool Club \$94.50**



SPINDLE NUT

GW GEARWRENCH



KDT41660D
6pc 1/2" Dr. Spindle Nut Service Kit
For most 4WD SUV and light truck axle locknut applications.
Sale \$124.94 **Tool Club \$99.95**

KDT2467
4WD Spindle Nut Wrench
Ford, Chevy, GMC & Dodge.
Sale \$33.69 **Tool Club \$26.95**



KDT3246D
4WD Spindle Nut Wrench
For Ford F250 / F350.
Sale \$61.56 **Tool Club \$49.25**



CTA1083
Ford Transit Rear Hub 4 pt socket for removing the rear hub 2014 & up Ford Transit
Sale \$71.63 **Tool Club \$57.30**



CTA1212
12 Pin Hub Nut Socket - RAM
For Ram 2019+ 3500, 4500, 5500 (D2, DD, DP)
Sale \$79.69 **Tool Club \$63.75**



CTA1084
Mercedes Benz Axle Nut Socket
6 tabs Services Sprinter Rear Axle Ball Joint
Sale \$58.89 **Tool Club \$47.11**



AME37330
Hub Buddy Impact Lug / Hub Surface Cleaner
Use with 1/2" impact wrench. Removes rust and corrosion.
Sale \$46.88 **Tool Club \$37.50**



AME37335
Disc Refill Pack
Sale \$49.94 **Tool Club \$39.95**

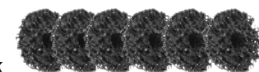

SUNEX TOOLS

SUN1812
9pc Deep **METRIC** Set
Sizes: 5.5 - 13mm
Sale \$42.81
Tool Club \$34.25



SUN1830
10pc 1/4" Dr. 6PT **SAE**
Deep Magnetic
SAE: 3/16" - 9/16"
Sale \$112.44
Tool Club \$89.95



SUN1848
48pc Master Impact Set
SAE: 3/16" - 9/16"
Metric: 4 - 15mm
Both in standard and deep.
Sale \$124.94
Tool Club \$99.95



SUN1814
12pc **METRIC** Swivel Set
Sizes: 5 - 15mm
Sale \$160.31
Tool Club \$128.25



SUNEX TOOLS

SUN1874
74pc 1/4" Dr. Master Set
Short: 4 to 15mm, 3/16" to 9/16"
Deep: 5.5 to 15mm, 3/16" to 9/16"
Swivel: 5 to 15mm, 1/4" to 9/16"
Torx: T10, T15, T20, T25, T27 & T30
Universal joint, 2", 4" & 6" extensions
3/8" adapter.
Sale \$374.94 **Tool Club \$299.95**



1/4" MAGNETIC



SUN1820
10pc 1/4" Dr. 6PT **SAE**
Magnetic Impact Socket Set
Sizes: 3/16" - 9/16"
Sale \$54.94 **Tool Club \$43.95**



SUN1822
12pc 1/4" Dr. 6PT **METRIC**
Magnetic Impact Socket Set
Sizes: 5mm - 15mm
Sale \$60.31 **Tool Club \$48.25**



SUN1825
11pc 1/4" Dr. 12PT **METRIC**
Magnetic Universal Impact Socket Set
Sizes: 5mm - 15mm
Sale \$187.44 **Tool Club \$149.95**

3/8" DRIVE IMPACT

SUN3358
13pc **METRIC**
Sizes: 7 - 19mm
Sale \$37.44
Tool Club \$29.95



SUN3675
13pc **METRIC**
ALL 12PT
Sizes: 7 - 19mm
Sale \$47.44
Tool Club \$37.95



SUN3359
13pc **METRIC**
Sizes: 7 - 19mm
Sale \$60.63
Tool Club \$48.50



SUN3657
10pc **METRIC**
Swivel
Sizes: 10 - 19mm
Sale \$144.06
Tool Club \$115.25



SUN3691
13pc **METRIC**
Swivel - 12pt
Sizes: 7 - 19mm
Sale \$163.44
Tool Club \$130.75



SUN3329
29pc **METRIC**
Standard/DEEP
Sizes: 8 - 19, 21 & 22mm plus
Universal Joint
Sale \$144.06
Tool Club \$115.25



SUN3330
29pc **METRIC**
ALL 12PT
Standard/DEEP
Sockets: 8 - 22mm
Includes universal joint.
Sale \$141.56
Tool Club \$113.25



SUN3325
25pc **SAE**
Master Set
5/16" - 1" &
U-Joint
Sale \$144.06
Tool Club \$115.25



SUN3326
25pc **SAE**
Master Set
ALL 12PT
5/16" - 1" &
U-Joint
Sale \$144.06
Tool Club \$115.25



SUN3360DD
28pc
Master Deep
Impact Set
Metric: 8 to 22mm
SAE: 5/16" - 1"
Sale \$141.56
Tool Club \$113.25



SUN3342
42pc
Master
Impact Set
SAE: 5/16" - 3/4"
Metric: 8 to 19mm
Short & Deep. Universal joint & 3" Extension
Sale \$144.06 **Tool Club \$115.25**



SUNEX TOOLS BIGGEST 3/8" IMPACT SET IN ONE BOX!

SUN3580
80pc 3/8" Drive
Master Impact Socket Set
Includes SAE, Metric, Short, Deep, Swivel,
Torx, E-Torx, Extensions, & Universal Joint.
Sale \$331.88 **Tool Club \$265.50**



1/2" DRIVE IMPACT

SUN2653
14pc METRIC
 Sizes: 10 - 19, 21, 22, 26 & 27mm
 Sale \$100.94
Tool Club \$80.75



SUN2646
26pc METRIC
 Sizes: 10 - 36mm
 Sale \$250.94
Tool Club \$200.75



SUN2851
12pc 1/2" Dr. 5" Metric Extra Long Impact Set
 Sizes: 13, 14, 15, 16, 17, 18, 19, 20, 21, 22, 23, 24mm.
 Sale \$274.94
Tool Club \$219.95



SUN2652
14pc METRIC
 Sizes: 10 - 19, 21, 22, 26 & 27mm
 Sale \$61.19
Tool Club \$48.95



SUN2672
15pc METRIC 12PT SET
 Sizes: 10 - 24mm
 Sale \$115.44
Tool Club \$92.35



SUN2852
9pc 1/2" Dr. 5" Metric Extra Long Impact Set
 Sizes: 26, 27, 28, 29, 30, 31, 32, 33, 34mm.
 Sale \$316.19
Tool Club \$252.95



SUN2679
13pc METRIC 12PT SET
 Sizes: 10 - 19, 21, 22 & 24mm
 Sale \$61.19
Tool Club \$48.95



SUN2669
39pc METRIC
 Sizes: 9 - 30mm short and deep.
 Sale \$219.94
Tool Club \$175.95



SUN2658
10pc METRIC Deep Swivel
 Sizes: 10 - 19mm
 Sale \$187.81
Tool Club \$150.25



SUN2826
26pc METRIC 12PT SET
 Sizes: 10 - 36mm
 Sale \$158.75
Tool Club \$127.00



SUN2665
13pc METRIC Swivel
 Sizes: 12 - 24mm
 Sale \$259.69
Tool Club \$207.75



SUN5153DD
29pc METRIC & SAE Deep Impact Set
Metric: 10 - 27mm,
SAE: 7/16" to 1-1/4" plus 2 flip sockets.
 Sale \$199.94
Tool Club \$159.95



LOW PROFILE SOCKETS

- Hex shank drive for hand tool use **NEW!**
 - Low profile design for limited clearance



AST78310
10pc 3/8" Drive SAE Nano Impact Sockets
 Sizes: 1/4" - 3/4". All sockets feature a 17mm outside hex access when used with a wrench.
 Sale \$36.24 **Tool Club \$29.00**



AST78314
14pc 3/8" METRIC Drive Nano Impact Sockets
 Sizes: 6MM - 19MM. All sockets feature a 17mm outside hex access when used with a wrench.
 Sale \$43.69 **Tool Club \$34.95**



AST78211
11pc 1/2" Drive SAE Nano Impact Sockets
 Sizes: 3/8" - 1". All sockets feature a 22mm outside hex access when used with a wrench.
 Sale \$51.56 **Tool Club \$41.25**



AST78215
15pc 1/2" METRIC Drive Nano Impact Sockets
 Sizes: 10MM - 24MM. All sockets feature a 22mm outside hex access when used with a wrench.
 Sale \$64.38 **Tool Club \$51.50**



SUN2655
7pc METRIC Swivel
 Sizes: 13 - 19mm
 Sale \$115.44
Tool Club \$92.35



SUN2678
14pc SAE 12PT SET
 Sizes: 7/16", 1/2", 9/16", 5/8", 11/16", 3/4", 13/16", 7/8", 15/16", 1", 1-1/16", 1-1/8", 1-3/16" & 1-1/4"
 Sale \$80.63
Tool Club \$64.50



SUN2651
13pc SAE
 Sizes: 7/16", 1/2", 9/16", 5/8", 11/16", 3/4", 13/16", 7/8", 15/16", 1", 1-1/16", 1-1/8" & 1-1/4"
 Sale \$99.69
Tool Club \$79.75



SUN2668
39pc SAE Set
 Sizes: 3/8" to 1-1/2" plus universal joint.
 Sale \$267.44
Tool Club \$213.95



SUN2698
39pc 1/2" Dr. 12PT SAE Master Impact Socket Set
 Standard Sizes: 3/8" - 1-1/2"
 Deep Sizes: 3/8" - 1-1/2"
 Sale \$295.31 **Tool Club \$236.25**



SUN2699
39pc 1/2" Dr. 12PT METRIC Master Impact Socket Set
 Standard Sizes: 9mm - 30mm
 Deep Sizes: 9mm - 30mm
 Sale \$274.94 **Tool Club \$219.95**





3/8" DRIVE IMPACT

SKT4062
12pc METRIC
Short Set
 Sizes: 8, 9, 10, 11, 12, 13, 14, 15, 16, 17, 18 & 19mm
 Sale \$93.69
Tool Club \$74.95



SKT4058
8pc SAE Short Set
 Sizes: 5/16", 3/8", 7/16", 1/2", 9/16", 5/8", 11/16" & 3/4"
 Sale \$69.38
Tool Club \$55.50



SKT4082
12pc METRIC
Deep Set
 Sizes: 8, 9, 10, 11, 12, 13, 14, 15, 16, 17, 18 & 19mm
 Sale \$117.44
Tool Club \$93.95



SKT4078
8pc SAE 6pt. Deep Set
 Sizes: 5/16", 3/8", 7/16", 1/2", 9/16", 5/8", 11/16" & 3/4"
 Sale \$74.94
Tool Club \$59.95



SKT4090
METRIC/SAE 40pc Master Set
SAE: 5/16", 3/8", 7/16", 1/2", 9/16", 5/8", 11/16", & 3/4" short and deep sockets
METRIC: 8, 9, 10, 11, 12, 13, 14, 15, 17, 18 and 19mm short and deep sockets
 Sale \$287.44 **Tool Club \$229.95**

SKT33351
10pc METRIC
Swivel Set
 Sizes: 10, 11, 12, 13, 14, 15, 16, 17, 18 & 19mm
 Sale \$212.44
Tool Club \$169.95



SKT33300
8pc SAE
Swivel Set
 Sizes: 5/16", 3/8", 7/16", 1/2", 9/16", 5/8", 11/16" & 3/4"
 Sale \$199.94
Tool Club \$159.95



1/2" DRIVE IMPACT

KDT84918N
15pc Metric
Swivel Set
 Sizes: 8, 9, 10, 11, 12, 13, 14, 15, 16, 17, 18, 19, 20, 21 & 22mm.
 Sale \$174.94
Tool Club \$139.95



KDT84939N
15pc Metric
Swivel Set
 Sizes: 10, 11, 12, 13, 14, 15, 16, 17, 18, 19, 20, 21, 22, 23 & 24mm
 Sale \$199.94 **Tool Club \$159.95**



SKT4035
15pc SAE
Short Set
 Sizes: 3/8", 7/16", 1/2", 9/16", 5/8", 11/16", 3/4", 13/16", 7/8", 15/16", 1", 1-1/16", 1-3/16" & 1-1/4"
 Sale \$162.44 **Tool Club \$129.95**



SKT4036
17pc METRIC
Short Set
 Sizes: 8, 9, 10, 11, 12, 13, 14, 15, 16, 17, 18, 19, 20, 21, 22, 23 & 24mm
 Sale \$162.44 **Tool Club \$129.95**



SKT4048
15pc METRIC
Deep Set
 Sizes: 10mm - 24mm
 Sale \$219.38
Tool Club \$175.50



SKT4039
19pc SAE
Short Set
 Sizes: 3/8", 7/16", 1/2", 9/16", 5/8", 11/16", 3/4", 13/16", 7/8", 15/16", 1", 1-1/16", 1-1/8", 1-3/16", 1-1/4", 1-5/16", 1-3/8", 1-7/16" & 1-1/2"
 Sale \$262.44 **Tool Club \$209.95**



SKT4038
23pc METRIC
Short Set
 Sizes: 10mm - 27mm, 29, 30, 32, 36 & 46mm
 Sale \$281.19 **Tool Club \$224.95**



SKT4047
26pc METRIC
Deep Set
 Sizes: 10 - 30mm, 32, 33, 34, 35 & 36mm
 Sale \$462.44 **Tool Club \$369.95**



SKT4049
19pc SAE Deep Set
 Sizes: 3/8", 7/16", 1/2", 9/16", 5/8", 11/16", 3/4", 13/16", 7/8", 15/16", 1", 1-1/16", 1-1/8", 1-3/16", 1-1/4", 1-5/16", 1-3/8", 1-7/16", 1-1/2".
 Sale \$349.94 **Tool Club \$279.95**



SKT4037
25pc METRIC
Short Set
 Sizes: 8mm - 32mm & 36mm.
 Sale \$274.94 **Tool Club \$219.95**



SKT34350
15pc METRIC
Swivel Set
 Sizes: 10mm - 24mm
 Sale \$437.44
Tool Club \$349.95



SKT4053
30pc METRIC
Master Set
 Short: 8mm - 24mm
 Deep: 10mm - 24mm
 Sale \$306.19 **Tool Club \$244.95**



SKT4051
28pc SAE Master Set
 Short & Deep: 3/8", 7/16", 1/2", 9/16", 5/8", 11/16", 3/4", 13/16", 7/8", 15/16", 1", 1-1/16", 1-1/8", 1-1/4"
 Sale \$312.44 **Tool Club \$249.95**



3/4" DRIVE IMPACT

SUNEX[®] TOOLS
IMPACT SOCKETS
LIFETIME WARRANTY!

IMPACT SETS

SUN4684
 17pc 3/4" Dr. H.D.
METRIC Socket Set
 Sizes: 26mm - 46mm
 Sale \$343.69
Tool Club \$274.⁹⁵



6 PT MM

SUN4687
 9pc 3/4" Dr. 12pt **SAE** Impact Socket Set
 Sizes: 3/4", 13/16", 7/8", 15/16",
 1", 1-1/8", 1-3/16" and 1-1/4".
 Sale \$158.75 **Tool Club \$127.⁰⁰**



6 PT SAE

SUN4692
 26pc **METRIC** Short
 Sizes: 19 - 36,
 46 & 50mm.
 Sale \$412.44
Tool Club \$329.⁹⁵



6 PT MM

SUN4683
 17pc **SAE**
 Large Sizes
 1" to 2"
 Sale \$412.44
Tool Club \$329.⁹⁵



6 PT SAE



3/4 6 PT SAE

SUN4696
 29pc 3/4" **SAE** Short Set
 3/4, 13/16, 7/8, 15/16, 1, 1-1/16, 1-1/8, 1-3/16,
 1-1/4, 1-5/16, 1-3/8, 1-7/16, 1-1/2, 1-9/16, 1-5/8,
 1-11/16, 1-3/4, 1-13/16, 1-7/8, 1-15/16, 2, 2-1/16,
 2-1/8, 2-3/16, 2-1/4, 2-5/16, 2-3/8, 2-7/16, 2-1/2".
 Sale \$707.44 **Tool Club \$565.⁹⁵**

SUN4686
 17pc 3/4" Dr. Deep
METRIC Socket Set
 Sizes: 26mm - 44mm
 Sale \$549.94
Tool Club \$439.⁹⁵



6 PT MM

SUN4681
 8pc **SAE** Deep
 Sizes: 1", 1-1/16",
 1-1/8", 1-1/4",
 1-5/16", 1-3/8",
 1-7/16" & 1-1/2"
 Sale \$137.44
Tool Club \$109.⁹⁵



6 PT SAE

SUN4693
 26pc **METRIC** Deep
 Sizes: 19 - 36,
 46 & 50mm. 6 point.
 In blow molded case.
 Sale \$537.44
Tool Club \$429.⁹⁵



6 PT MM



6 PT SAE

SUN4685
 17pc **SAE** Deep large Sizes
 Sizes 1" to 2"
 Sale \$544.38 **Tool Club \$435.⁵⁰**

3/4 6 PT SAE

SUN4695
 29pc 3/4" **SAE**
 All deep sockets.
 3/4, 13/16, 7/8, 15/16, 1, 1-1/16, 1-1/8, 1-3/16,
 1-1/4, 1-5/16, 1-3/8, 1-7/16, 1-1/2, 1-9/16, 1-5/8,
 1-11/16, 1-3/4, 1-13/16, 1-7/8, 1-15/16, 2, 2-1/16,
 2-1/8, 2-3/16, 2-1/4, 2-5/16, 2-3/8, 2-7/16, 2-1/2".
 Sale \$852.44 **Tool Club \$681.⁹⁵**



WHEEL IMPACT SOCKET

SUN5697M
 1" Dr. Metric Deep
Impact Socket Set
 Sizes: 27mm, 33mm, 35mm
 36mm, 41mm, 17mm Square
 21mm Square.
 Sale \$199.94 **Tool Club \$159.⁹⁵**



6 PT MM

SUN4632
 11pc Wheel
**Service Impact
 Socket Set**
 6PT: 3/4", 13/16", 7/8", 1", 1-3/16", 33mm
 Thin Wall Deep: 1-1/16", 1-1/8", 1-1/4"
 Deep Budd Wheel: 1-1/2"
 Square Drive: 13/16"
 Sale \$216.56 **Tool Club \$173.²⁵**



SAE MM

SUN4011M
 3/4" Drive Metric
**Truck Service
 Impact Socket Set**
 27 mm, 30 mm, 32 mm, 33 mm,
 35 mm, 36 mm, 38 mm, 41 mm,
 Square 17 mm, 20 mm, 21 mm
 Sale \$249.95 **Tool Club \$199.⁹⁵**



6 PT MM

1" DRIVE IMPACT

SUN5693
 21pc 1" Dr. **SAE** Deep Impact
 Set includes in SAE - inches: 3/4, 13/16, 7/8,
 15/16, 1, 1-1/16, 1-1/8, 1-3/16, 1-1/4, 1-5/16,
 1-3/8, 1-7/16, 1-1/2, 1-9/16, 1-5/8, 1-11/16,
 1-3/4, 1-13/16, 1-7/8, 1-15/16, 2
 Sale \$624.94 **Tool Club \$499.⁹⁵**



SUNEX[®]
 TOOLS

CASE
 WITH
 WHEELS

1" 6 PT SAE

SUN5692
 21pc 1" Dr. **SAE**
Impact Socket Set
 Set includes in SAE - inches: 3/4, 13/16, 7/8,
 15/16, 1, 1-1/16, 1-1/8, 1-3/16, 1-1/4, 1-5/16,
 1-3/8, 1-7/16, 1-1/2, 1-9/16, 1-5/8, 1-11/16,
 1-3/4, 1-13/16, 1-7/8, 1-15/16, 2
 Sale \$449.94 **Tool Club \$359.⁹⁵**



1" 6 PT SAE

SUN5616
 1" Dr. 14pc **SAE** Impact Socket Set
 Set includes Standard Size 1" Dr.
 2-1/16", 2-1/8", 2-3/16", 2-5/16", 2-3/8", 2-1/2",
 2-9/16", 2-5/8", 2-11/16", 2-3/4", 2-13/16",
 2-7/8", 2-15/16", 3"
 Sale \$962.44 **Tool Club \$769.⁹⁵**



1" 6 PT SAE

IMPACT UNIVERSAL JOINTS

SUN3305

5pc, 3/8" & 1/2" Drive Adapter & Impact Universal Joint Set
1/2" & 3/8" Dr. Universals,
3/8"F x 1/2"M Adapter,
1/2"F x 3/8"M Adapter, &
1/2"F x 3/4"M Adapter
Sale \$64.94
Tool Club \$51.95



SUN2343

Super Reducer Adapter Set
1/2"F x 3/8"M,
3/8"F x 1/4"M
& 3/4"F x 1/2"M
Sale \$43.69
Tool Club \$34.95



WILW83183

5pc Head Bolt Socket Set
4-1/2" Length 12pt
1/2 in. 10mm, 12mm,
13mm, and 14mm for
Nissan, Toyota, Honda,
and Ford/GM vehicles
Sale \$49.94 **Tool Club \$39.95**

NEW!



1/2 12-PT

Performance Tool

TIT42173

3pc 1/2" Dr. X-Long Impact Extension Set
Sizes: 18", 24", & 36".
Sale \$85.94
Tool Club \$68.75



1/2

TITAN

SUN2504

4pc 1/2" Drive Wobble Extension Impact Set
Sizes: 3", 5", 10" & 15".
Wobble drive provides
15° offset.
Sale \$61.25
Tool Club \$49.00



1/2

SUNEX TOOLS

TIT40000

8pc Impact Adapter Set
1"F x 3/4"M,
3/4"F x 1/2"M,
1/2"F x 3/8"M, 1/4"F x 3/8"M,
3/8"F x 1/2"M, 1/2"F x 3/4"M & 3/4"F x 1"M
Sale \$62.44 **Tool Club \$49.95**



NEW!

TITAN

TIT81483
17pc Impact Adapter & Wobble Extension Set
1/4", 3/8" & 1/2" U-Joints,
9 extensions & multiple
1/4", 3/8" & 1/2" adapters.
Sale \$69.94 **Tool Club \$55.95**



NEW!

EXTENSION SETS

SUN3500

4pc 3/8" Dr. Extension Set
Sizes: 3", 5", 10" & 15"
Sale \$74.38
Tool Club \$59.50



3/8

SUNEX TOOLS

SUN2500

4pc 1/2" Dr. Extension Set
Sizes: 3", 5", 10" & 15"
Sale \$84.38
Tool Club \$67.50



1/2

SUN3501

3pc 3/8" Drive Locking Impact Extension Kit
Sizes: 3", 6", 12".
Sale \$71.56 **Tool Club \$57.25**



3/8

SUNEX TOOLS

IMPACT UNIVERSAL JOINTS

SK
PROFESSIONAL TOOLS

SUNEX
TOOLS

Part #	Size	Sale	Club
SKT33990	3/8"	\$41.19	\$32.95
SKT34990	1/2"	\$45.63	\$36.50
SUN1800	1/4"	\$12.81	\$10.25
SUN3301	3/8"	\$19.19	\$15.35
SUN2300	1/2"	\$26.88	\$21.50
SUN4304	3/4"	\$57.81	\$46.25
SUN5304	1"	\$80.00	\$64.00

DRIVELINE SOCKETS

SUN2696

7pc SAE Driveline
Sizes: 5/16", 3/8",
7/16", 1/2", 9/16",
11/16" & 3/4"
Sale \$201.88
Tool Club \$161.50



12-PT SAE

SUN2695

9pc Metric Driveline
Sizes: 8mm,
10mm - 17mm
Sale \$243.13
Tool Club \$194.50



12-PT MM

SUN212ZUMDL
12mm Ford Driveline Impact Socket
Sale \$41.19
Tool Club \$32.95



12-PT

1/2" DR. EXTENSIONS

Part #	Length	Sale	Club
SKT46169	2"	\$18.69	\$14.95
SKT46170	3"	\$22.44	\$17.95
SKT46171	5"	\$28.13	\$22.50
SKT46172	10"	\$33.13	\$26.50
SKT46174	23"	\$46.19	\$36.95
SKT46175	35" for transmission	\$64.94	\$51.95
SUN2503	3"	\$11.25	\$9.00
SUN2505	5"	\$15.94	\$12.75
SUN2510	10"	\$26.69	\$21.35
SUN2515	15"	\$40.00	\$32.00
SUN2524	24"	\$57.81	\$46.25
SUN2536	36"	\$71.88	\$57.50
SUN2536T	36" for transmission	\$78.69	\$62.95

SK SUNEX TOOLS

3/4" DR. EXTENSIONS

Part #	Length	Sale	Club
SUN4302	6"	\$28.75	\$23.00
SUN4310	10"	\$38.44	\$30.75
SUN4313	13"	\$50.63	\$40.50



1" DR. EXTENSIONS

Part #	Length	Sale	Club
SUN5300	6"	\$51.19	\$40.95
SUN5310	10"	\$57.81	\$46.25
SUN5313	13"	\$65.63	\$52.50

IMPACT ADAPTERS

Part #	Size	Sale	Club
SKT45684	3/8"F x 1/2"M	\$23.13	\$18.50
SKT45685	1/2"F x 3/8"M	\$21.88	\$17.50
SKT46184	1/2"F x 3/4"M	\$22.44	\$17.95
SKT46186	1/2"F x 3/4"M w/ball retainer	\$22.44	\$17.95
SKT84609A	3/4"F x 1/2"M	\$49.94	\$39.95
SUN3303	3/8"F x 1/4"M	\$11.69	\$9.35
SUN3300	3/8"F x 1/2"M	\$10.94	\$8.75
SUN2303	1/2"F x 3/8"M	\$19.38	\$15.50
SUN4305	3/4"F x 1/2"M	\$31.88	\$25.50
SUN4300	3/4"F x 1"M	\$26.56	\$21.25
SUN5305	1"F x 3/4"M	\$45.94	\$36.75



CORDED

BAYSL2135
1,200 Lumen Corded LED
Work Light with Magnetic Hook
 Two Brightness Settings: 1,200 & 600 Lumens. Two built in magnets. Included magnetic hook can be attached to either of the built in magnets. 25ft cord.
 Sale \$93.13 **Tool Club \$74.50**



WILW2240
1200+ Lumen LED Drop Light
 Over 1,200 Lumens of bright white light. Impact resistant handle with rubber grip & magnetic bracket. Powder coated metal lamp shield with swivel hang hook.
 Sale \$43.69 **Tool Club \$34.95**



WILW2237
120V LED Drop Light
 1000 Lumens. 25ft 18GA grounded cord. Impact resistant handle w/ non-slip rubber grip. Powder coated lamp shield w/ swivel hang hook.
 Sale \$37.44 **Tool Club \$29.95**



WILW2402
Wide Angle LED Work Light
 2,000+ Lumens. SMD LED technology - stays cool to the touch! Wide angle LEDs. 16ft power cable.
 Sale \$73.13 **Tool Club \$58.50**



BAYSL1514
LED Single Fixture Work Light with Magnetic Base
 2,200 Lumens. 20W LED. Powerful magnetic base. Multi-angle tilt and swivel. Multi-heat sink keeps light cool to the touch. 50,000 Hours of life. Tempered glass lens. 12ft cord.
 Sale \$95.94 **Tool Club \$76.75**



UNDERHOOD LIGHTS

MLW2125-21XC
M12 Underhood Light
 1,350 lumens. Extends from 47" - 78" long. Up to 8 hours runtime. Includes light, M12 extended battery, & charger.
 Sale \$312.44 **Tool Club \$249.95**



MLW2125-20
M12 Underhood Light - TOOL ONLY
 Sale \$249.94 **Tool Club \$199.95**



AST151SL
Rechargeable Slim Aluminum Underhood Light
 1510 lumens. Hooks adjust from 45.5" - 82". Independent swivel tension hooks allows you to point the light where you need it. 500 - 1510 lumens w/ power button dimming function. 2.5-6 hour run time. Impact & water resistant IK07 & IP54.
 Sale \$144.38 **Tool Club \$115.50**



REELS

BAYSL851
Incandescent Work Light with Metal Guard on 50ft Metal Reel
 Metal bulb guard with integrated rubber-tipped hook. Rated to handle up to a 75W incandescent bulb (not included). Flame retardant polypropylene handle. Attached to a 50ft retractable cord inside of a metal reel. Includes mounting brackets for attaching the reel to the wall or ceiling.
 Sale \$84.69 **Tool Club \$67.75**



BAYSL866
1,200 Lumen LED Work Light with Magnetic Hook on Retractable Reel
 Two brightness settings: 1,200 & 600 Lumens. Attached to 50ft of 18/2 SVT cord inside a retractable metal reel.
 Sale \$149.94 **Tool Club \$119.95**



BAYSL425A
Incandescent Work Light with Metal Guard & Single Outlet
 Polarized plug with 12-amp grounded receptacle. Rated for up to a 75W incandescent bulb (not included). 25ft cord.
 Sale \$31.56 **Tool Club \$25.25**



BAYSL426A
Incandescent Work Light with Metal Guard & Single Outlet
 Polarized plug with 12-amp grounded receptacle. Rated for up to a 75W incandescent bulb (not included). 50ft cord.
 Sale \$53.44 **Tool Club \$42.75**



BAYSL204
Replacement Incandescent Work Light Head w/ Metal Guard
 Replacement incandescent work light head w/ metal guard & single outlet that fits the following models: 450 & 840.
 Sale \$9.69 **Tool Club \$7.75**



WILW2279
1000 Lumens 120-Volt Workbench Power Station
 (6) 120V electrical outlets, (2) USB ports and (2) swivel LED lights that put out a total of 1000 lumens. Measures 27.75" x 4.75"
 Sale \$74.94 **Tool Club \$59.95**



LIGHT BULBS

WILW2282
12W 120V LED Light Bulb
 1,200 Lumens. Equivalent to a 75W bulb and fits most standard sockets.
 Sale \$9.38 **Tool Club \$7.50**



NEB-ARE-0001
9000 Garage Light HIGH BRIGHT™
 9,000 lumens. 4 LED light panels up to 90° movement. 60-watt power draw.
 Sale \$62.49
Tool Club \$49.99



EXTENSION CORD

BAYSL725
25' Extension Cord w/ Single Outlet
 25 foot length cord with a 16/3 gauge SJTW cold weather-rated cord rated at 13 amps
 Sale \$23.13 **Tool Club \$18.50**



BAYSL750
50' Extension Cord w/ Single Outlet
 50 foot length cord with a 16/3 gauge SJTW cold weather-rated cord rated at 13 amps
 Sale \$43.69 **Tool Club \$34.95**



WILW2256
25' Blue Extension Cord
 Indoor/ Outdoor 16ga with Lighted LED outlet
 Sale \$24.94 **Tool Club \$19.95**



WILW2257
50' Blue Extension Cord
 Indoor/ Outdoor 16ga with Lighted LED outlet
 Sale \$37.44 **Tool Club \$29.95**



WILW2270
25ft Extension Cord
 High Visibility 16ga Orange with single outlet
 Sale \$24.94 **Tool Club \$19.95**



WILW2271
50ft Extension Cord
 High Visibility 16ga Orange with single outlet
 Sale \$37.44 **Tool Club \$29.95**



WILW2273
50' Retractable Cord Reel
 50ft 16GA cord with polarized plug and 3 grounded 10 AMP outlets
 Sale \$124.94 **Tool Club \$99.95**



WILW2266
8-in-1 Multi-Tap Outlet
 120-volt outlets 3 standard USB ports and 1 USB-C port. 5ft Cord
 Sale \$34.94
Tool Club \$27.95





Astro Pneumatic

AST80SL
800 Lumen Rechargeable Slim Light with Quick-Swap System
 Dual COB LED 800 Lumen main light with thumb wheel adjustment. 150 Lumen top flashlight. Includes (1) 2,600mAh battery & (1) 4,500mAh battery, high output wall adapter, cable and charging base.
 Sale \$112.44 **Tool Club \$89.95**

AST52SL
500x2 Lumen Wirelessly Rechargeable Folding Double-Sided LED Slim Light
 Front & Back Lights each 500 Lumens, total 1000 Lumens. 4,400mAh battery for 3.25+ hours on high. Includes USB-C charging cable and adapter. Features 180° folding design.
 Sale \$68.69 **Tool Club \$54.95**

AST90SL
900 LM Wirelessly Rechargeable LED Slim Light w/ Top Flashlight
 900 Lumens USB-C Charger Press and hold to adjust from 70-720 lumens. Swivel Magnetic Base.
 Sale \$72.44 **Tool Club \$57.95**

WILW2231
30 LED Slim Work Light
 Dial adjust light output from 150 to over 600 lumens. Swivel Magnetic Base
 Sale \$24.94 **Tool Club \$19.95**

MXN01010
3 Way Folding Inspection Light
 10" Led Rechargeable 600Lumens USB-C, Front,Back,Top Light. Best for inspections
 Sale \$58.69 **Tool Club \$46.95**

KKLC1541
COB LED Work Light
 500 lumens. 60 lumen focus beam. Swivel handle rotates 180° and features a magnetic backing.
 Sale \$66.19 **Tool Club \$52.95**



WorkStar Cyclops LED Light - Square array of 9 LEDs & a wide angle lens for a perfectly round beam pattern. 420 lumens. USB-C rechargeable.
MXN00810 - Red
MXN00811 - Green
MXN00812 - Yellow
MXN00814 - Blue
 Sale \$43.69 **Tool Club \$34.95**



MXN00900
MAXXBEAM Zoom Work Light
 300, 600 or 1200 Lumens. USB-C rechargeable battery. 2 - 11 hour run time. 6X zoom adjustable focus. Max range of 656ft.
 Sale \$93.69 **Tool Club \$74.95**

NEB-WLT-1007 Slim+ 1200
1200Lumen Powerful Rechargeable Pocket Light with Laser Pointer and Power Bank. USB-C charger.
 Sale \$62.49 **Tool Club \$49.99**

NEB-FLT-1042 Slim Mini Rechargeable Pocket Light
 250 or 25 lumens pushbutton switch and a USB-C charging port
 Sale \$24.99 **Tool Club \$19.99**

AST98SL Mini Flood Worklight
980 Lumen Rechargeable Dual-Beam. Small 3" x 4.3" worklight with LED spot & COB lights
 Sale \$49.94 **Tool Club \$39.95**

AST100SL
1,000 Lumen Wirelessly Rechargeable Mini LED Flood Light
 100-1,000 lumens. Massive 4,500mAh capacity Li-ion battery for 3-18 hours of runtime. Includes USB-C charging.
 Sale \$62.44 **Tool Club \$49.95**

NEB-WLT-1008 OMNI™ 3K
3,000 Lumen Light
 360 COB 4,000mAh Magnetic hand Kickstand. 6 light mode USB-C Charger
 Sale \$81.24 **Tool Club \$64.99**

MAXXEON

NEW!

EZRNK10 ANYWHERE™ Neck Light
 200 Lumens. 2 AA Batteries. 70° Arc flexible adjusting. 2.5 hour run time.
 Sale \$33.13 **Tool Club \$26.50**



EZRNK15 ANYWHERE™ Neck Light
 300 Lumens. USB rechargeable. 70° Arc flexible adjusting. 2.5 hour run time.
 Sale \$62.44 **Tool Club \$49.95**



MXN00510 LeechLight
 Low 120 lm / 6 hours High 320 lm / 2 hours. One switch button to control both heads
 Sale \$62.44 **Tool Club \$49.95**



MXN00630 WorkStar® Technician's Rechargeable Headlamp
 700 daylight-white lumens. 6X Zoom lens. Rear safety light. Head tilts 90° with 4 indented positions. Front mounted power/brightness switch. 4 LED battery status indicator.
 Sale \$58.69 **Tool Club \$46.95**



MXN00500 Workstar® Droid Technician's Rechargeable LED Mini Headlamp
 High: 400 lumens, Low: 160 Lumens. Light head aims forward & securely pivots down 72° through 6 indented positions
 Sale \$39.38 **Tool Club \$31.50**



NEB-POC-1000 Inspector 500+ Rechargeable Flashlight
 500 lumen, rechargeable, waterproof (IPX7) penlight and expandable area light
 Sale \$56.24 **Tool Club \$44.99**



NEB-FLT-1006 TORCHY™ 2K
2000 Lumen Rechargeable Pocket Flashlight
 Sale \$62.49 **Tool Club \$49.99**



NEB-FLT-1015 DAVINCI® 18000
18,000 Lumen Flash Light
 USB-C Charger, Waterproof IP67 Brightest Flashlight Eppys Stocks
 Sale \$287.49 **Tool Club \$229.99**



**SLT61520
BearTrap Rechargeable
Area Light**

2,000 Lumen Flood Light.
1,000 Lumen Spot Light.
Clamps virtually anywhere,
magnetic base, hang hook or
stands on its own. Rechargeable,
continue using while plugged in.
IPX4 Water resistant & 1m impact resistance.
Sale \$196.88 **Tool Club \$157.⁵⁰**

**SLT61510
Syclone® Compact
Rechargeable Work Light**

400 Lumens.
Spot and Flood Light features.
Cool White LEDs and 90 CRI LEDs.
IPX4 water-resistant. 2 meter impact-resistant.
Beam Distance: 141 meters. Head swivels
360° and is adjustable with one hand.
Hands-free features: magnetic base
or stowable hang-hook.
Sale \$72.81 **Tool Club \$58.²⁵**

**SLT88810
Wedge™ Slim
Everyday Carry
Flashlight - Black**

**SLT88811
Wedge™ Slim Everyday Carry
Flashlight - Coyote**
Features 2 lighting modes: Constant on &
THRO® mode for maximum brightness.
300 Lumens high; 1,000 Lumens THRO® mode.
USB-C rechargeable Lithium Polymer battery.
IPX7 waterproof to 1m; 1m impact resistance.
Sale \$118.13 **Tool Club \$94.⁵⁰**

**SLT66148
Stylus Pro USB UV Penlight**

400nm UV LED w/ 325 mW output.
Runs 2.5 hours. Rechargeable lithium ion battery.
Water-resistant. IPX4 water resistant.
1 meter impact resistance tested
Sale \$81.19 **Tool Club \$64.⁹⁵**

**SLT51063
Twin-Task
USB Rechargeable
Headlamp**

Elastic head strap. IPX4 water resistant.
120° tilting head. Spot & flood capability.
Sale \$82.62 **Tool Club \$66.¹⁰**

**SLT76801
Stinger Switchblade
Rechargeable
Multi-Function
Worklight**

5 lights in 1!
Drop light, hands
free, white light,
color-rite light,
and UV light. 180° rotating light bar.
Ultra thin design for tight spaces.
Sale \$138.13 **Tool Club \$110.⁵⁰**



**STINGER® 2020 Rechargeable
LED Flashlight with Charging Holder**
2,000 Lumens. High, Medium, Low and
Strobe modes. IPX7 waterproof. 2m impact
resistance tested. Mode switch for easy
selection of High, Medium & Low.
Includes "Y" USB cord & lanyard.

SLT78101 - (Black)
SLT78121 - (RED)
SLT78131 - (BLUE)
Sale \$207.44 **Tool Club \$165.⁹⁵**



**SLT78100
STINGER® 2020 Rechargeable
LED Flashlight - Tool Only**
2,000 Lumens. High, Medium, Low and
Strobe modes. IPX7 waterproof. 2m impact
resistance tested. Mode switch for easy
selection of High, Medium & Low.
Includes "Y" USB cord & lanyard.
Sale \$179.38 **Tool Club \$143.⁵⁰**



Stylus Pro USB Rechargeable Penlight
70 lumens. 3.5 hour runtime. USB Rechargeable
Li-ion battery. Water resistant.

SLT66140 - (BLUE)
SLT66144 - (GREEN)
Sale \$72.44 **Tool Club \$57.⁹⁵**

**SLT66118
Stylus Pro® Penlight**
Projects 48 lumens 70 yards.
Shockproof C4 LED. IPX4 for water resistance.
Sale \$31.19 **Tool Club \$24.⁹⁵**

**SLT66318
MicroStream LED Penlight**
C4 LED technology. IPX4 for water resistance.
52-meter beam lasts up to two hours.
Sale \$26.19 **Tool Club \$20.⁹⁵**

**SLT66601
Ultra-Compact Flashlight**
250 Lumen Rechargeable Flashlight.
1.5 hours of runtime on high.
Sale \$49.94 **Tool Club \$39.⁹⁵**



SLT75494 SLT75486 SLT75488 SLT75492
SLT75486 (BLUE)
SLT75488 (GREEN)
SLT75494 (RED)
SLT75492 (PURPLE)
**Stinger DS LED HL with AC/DC
Piggy Back Charger 640 Lumens**
• Dual switch technology.
• Three lighting modes, including strobe
• 297 meters of beam distance.
• C4® LED technology, impervious
to shock with a 50,000 hour lifetime.
• 3-cell, 3.6 Volt Ni-MH sub-C battery
• 10 hr. steady charge, 2.5 hr. fast charge,
or PiggyBack charger options.
• IPX4 water-resistant.
• Unbreakable polycarbonate lens
with scratch-resistant coating.
Sale \$229.38 **Tool Club \$183.⁵⁰**



SLT74769 - Lime Green
SLT74752 - Black
SLT74773 - Purple
SLT74767 - Blue
SLT74771 - Orange
SLT74775 - Red

Strion LED Rechargeable Flashlight
Three modes and strobe. Lithium Ion battery.
Clamp style charger. 500 lumens.
Up to 3.5 hours of runtime on low setting.
High mode range up to 200m.
Weighs only 5.2oz with battery.
Fully recharges in 3 hours.
Includes wall and 12v chargers.
Sale \$197.44 **Tool Club \$157.⁹⁵**



**SLT75863
Stinger® DS LED
HP Rechargeable Flashlight**
Made of aircraft-grade aluminum and coated
with slip-resistant rubber. 50,000 hours of life.
Dual switch intensity levels and strobe feature.
C4 LED technology. 3.6-volt battery is
rechargeable up to 1,000 times.
Sale \$209.94 **Tool Club \$167.⁹⁵**



HD REGULATORS

RELIEVING TYPE REGULATORS

- Offset 1/4" gauge ports serving as two 1/4" supply lines, allowing up to 3 regulated full flow out ports.
- Inlet pressure: 250 PSI • Max SCFM: 80
- Operating temperature: 40°F to 120°F

Part #	NPT	Sale	Club
MIL1113	1/4" NPT	\$69.38	\$55.50
MIL1114	3/8" NPT	\$69.38	\$55.50
MIL1115	1/2" NPT	\$83.13	\$66.50



FILTERS



METAL BOWL FILTERS ARE FOR HIGH PRESSURE, OVER 140 PSI.

Part #	Size	Sale	Club
MIL1018-8	1/4" NPT	\$93.69	\$74.95
MIL1019-8	3/8" NPT	\$93.69	\$74.95
MIL1020-8	1/2" NPT	\$93.69	\$74.95
MIL1120-8	1/2" NPT	\$112.44	\$89.95
MIL1022-8	3/4" NPT	\$168.69	\$134.95
MIL1122-8	1" NPT	\$187.44	\$149.95



AIR FILTRATION

AST2618

Air Control Unit

Large Filter with regulator. 50CFM capacity. 5 Micron filtration. Sale \$124.94

Tool Club \$99.95



AST2615

3/8" Filter/Regulator with Gauge

2" face. 1/4" or 3/8" NPT with Max 135psi. Sale \$59.69

Tool Club \$47.75



MIL1100M

1/4" NPT Deluxe FRL Trio

Filter, regulator and lubricator all in one. 150 PSI and 16 SCFM. 40 micron filter element. Sale \$274.94

Tool Club \$219.95



MIL1101M

3/8" NPT Deluxe FRL Trio

Filter, regulator and lubricator all in one. 200 PSI and 82 SCFM. 40 micron filter element. Sale \$324.94

Tool Club \$259.95



MIL1102M

1/2" NPT Deluxe FRL Trio

Filter, regulator and lubricator all in one. 250 PSI and 100 SCFM. 40 micron filter element. Sale \$331.19

Tool Club \$264.95



HIGH FLOW COUPLERS



PREMIUM HOSES, TOOLS & EQUIPMENT

DOUBLE

THE AMOUNT OF AIR FLOW TO YOUR TOOL!



Part #	Size	Sale	Club
LEGA53440FZ-2PK	1/4" 2pc	\$8.13	\$6.50
LEGA53452FZ	1/4" 3pc	\$21.19	\$16.95
LEGA53457FZ	1/4" 7pc	\$39.06	\$31.25
LEGA53458FZ	1/4" 14pc	\$80.63	\$64.50
LEGA53657FZ	3/8" 7pc	\$49.99	\$39.99

MILS685-4

3 in 1 Air Manifold

1/4" Air Inlet & 3 Outlets. Sale \$16.19

Tool Club \$12.95



TA99000

Air Tool Filter

Sale \$20.63

Tool Club \$16.50



TA98300

Air Regulator w/ Gauge

For paint spraying. Sale \$21.88

Tool Club \$17.50



TIT19442

In-Line Air Flow Regulator

1/4" NPT. Sale \$8.69

Tool Club \$6.95



MILS657

1/4" Swivel Connector

Sale \$16.19

Tool Club \$12.95



DYN95460

1/4" Aluminum Swivel

Sale \$33.69

Tool Club \$26.95



TIT19327

1/4" NPT Swivel Plug

30° Swivel action. Sale \$8.44

Tool Club \$6.75



MILS711

1/4" M-Style Air Coupler & Plug Set

Sale \$9.94

Tool Club \$7.95



MILS745

1/4" NPT Female AMT Style 3-Way Coupler

Sale \$14.38

Tool Club \$11.50



MIL1750

5 in ONE™ Universal Safety Exhaust Quick-Connect Industrial Coupler

1/4" NPT. Accepts all major interchanges: Industrial, High Flow, Automotive, ARO & Lincoln. Safely bleeds off air pressure before releasing connector. Max: 120 PSI. Sale \$23.69

Tool Club \$18.95



IPA8055

3pc Specialty Blow-Gun Asst. Includes 90° Blow-Gun, Scraper Blow-Gun & Straight Blow-Gun w/ perforated end for bolt holes. Sale \$82.44

Tool Club \$65.95



IPA8091

Flow-Thru System w/ Brush & Venturi

For cleaning, degreasing & application of various solvents. Interchangeable twist-wire stainless steel & industrial-strength nylon brushes. Sale \$199.06

Tool Club \$159.25



IPA8052

Air Comb® Filter & Radiator Cleaner - 36"

90° Multi-Port Air Gun

Sale \$54.94

Tool Club \$43.95

IPA8053

Air Comb® Filter & Radiator Cleaner - 48"

90° Multi-Port Air Gun

Sale \$60.44

Tool Club \$48.35

RE-KOIL AIR HOSE

- Maximum working pressure: 200 PSI @ 70°F
- Working temp: -40°F to 180°F
- Resists abrasions
- Material: Equivalent to nylon 12
- Full flow male NPT swivel fittings on both ends to avoid twisting and kinking



Part #	ID	Lgth.	Swivel Male NPT	Sale	Club
MIL1669	1/4"	25'	1/4"	\$29.38	\$23.50
MIL1670	1/4"	50'	1/4"	\$49.94	\$39.95
MIL1674	3/8"	25'	3/8"	\$56.19	\$44.95
MIL1674-4	3/8"	25'	1/4"	\$64.38	\$51.50
MIL1675	3/8"	50'	3/8"	\$95.31	\$76.25
MIL1675-4	3/8"	50'	1/4"	\$98.44	\$78.75

LEGHFZ3806YW2B

3/8" x 6' Swivel Whip Hose 1/4" MNPT

Sale \$18.69

Tool Club \$14.95



LEGHFZ1206YW3S

1/2" x 6' Swivel Whip Hose 3/8" NPT

Sale \$33.69

Tool Club \$26.95



RAP-M3800

1/2" Compressed Air Tubing Commercial / Shop Piping Kit

Semi flexible tubing 100 ft roll with adapters. Sale \$244.99

Tool Club \$195.99



BLOW GUNS

AST1717 - Green
AST1718 - Orange
4" Blow Gun
Sale \$12.81
Tool Club \$10.25



With removable rubber tip

AST1715
13" Blow Gun
Sale \$14.94
Tool Club \$11.95

AST1716
20" Blow Gun
Sale \$18.13
Tool Club \$14.50

TIT19994
48" Air Gun & Wand
Zinc Alloy Gun with 30 degree angled aluminum nozzle & rubber tip.
Air inlet: 1/4" NPT
Sale \$22.44
Tool Club \$17.95

LEGAG1500FZKIT
10pc Blow Gun Kit
Ergonomic gun body for max comfort & control
Sale \$49.99
Tool Club \$39.99

MILS699
1/4" Female Air Chuck
Sale \$3.13
Tool Club \$2.50

CTA1930
Straight Lock-On Air Chuck
Sale \$12.44
Tool Club \$9.95

WILW60309
Digital Dual Head Tire Gauge
Measures 5 - 99 PSI. LED spot for nighttime use. Measures in PSI, BAR, & KPA.
Sale \$24.94 **Tool Club \$19.95**

MILS153
1/4" NPT Lever Style Blow Gun
11.4 cubic feet per minute.
Straight rubber tip.
Sale \$18.69 **Tool Club \$14.95**

MILS148
1/4" NPT Lever Style Blow Gun
Includes safety nozzle & rubber tip.
Sale \$12.44 **Tool Club \$9.95**

MILS157
Siphon Spray Blow Gun Kit
For use with liquids only.
Includes 8' of tubing. 1/4" NPT.
Sale \$31.19 **Tool Club \$24.95**



MILS690-12
12" Dual-Head Air Chuck
12-1/4" overall length. Max. pressure: 150 PSI.
Sale \$19.94 **Tool Club \$15.95**

MILS693-12
12" Dual-Head Straight Foot Air Chuck
12-3/4" overall length. Max. pressure: 150 PSI
Sale \$24.94 **Tool Club \$19.95**

CTA1936
14" Dual-Head Straight Foot Air Chuck
Maximum Pressure 150 Pound
Sale \$18.44 **Tool Club \$14.75**

MILS690
Dual Head Chuck
Sale \$17.44 **Tool Club \$13.95**

MILS449
Tire Valve Tool
Sale \$13.69 **Tool Club \$10.95**

MILS976
Dual Head Tire Gauge
Range: 10 to 160 lb. Length: 12 3/4"
Sale \$29.94 **Tool Club \$23.95**

MILS928
Tractor Tire Gauge
2 sides 5 to 50 PSI & 40 to 350
Sale \$12.44 **Tool Club \$9.95**

MILS986
Service Gauge - Straight Foot Dual Head
Length: 13 1/4"
Sale \$33.69 **Tool Club \$26.95**

CTA1937
Automotive Tire Gauge
Range: 10 - 50 PSI or 75 - 325 kPa
Sale \$5.31 **Tool Club \$4.25**

MILEX516DIG
Digital Tire Gauge
360° swivel chick. Backlit display. Range: 5 - 100psi.
Sale \$27.44 **Tool Club \$21.95**



WILW10011
11 Gallon Portable Air Tank
Standard Schrader-type fill valve. On/Off air adjustment valve. Safety pressure bypass with manual override. Industrial-grade air hose with standard tire air chuck.
Sale \$98.69 **Tool Club \$78.95**

TIRE INFLATORS

AST3018
Digital Inflator Astro Pneumatic
New dual AAA battery powered design.
New 21" Stainless braided hose for increased durability.
Maximum accuracy & 0.1psi resolution. Displays KG, PSI or BAR measurement.
Large face backlit LCD display.
Unit covered with rubber sleeve for extra comfort and durability.
Two position lever. Easy Change Chuck System. Works with nitrogen systems and CO². Batteries included.
Sale \$110.63 **Tool Club \$88.50**



AST3081
Dial Tire Inflator
Inflate, deflate & measure tire pressure.
80mm pressure gauge (0-12 Bar/174PSI).
Aluminum die-casting unit covered with a rubber sleeve for extra comfort & durability.
2 position inflate/deflate lever.
Sale \$65.31 **Tool Club \$52.25**



MILS568
H.D. Digital Tire Pressure Gauge & Inflator w/ Lock-On Chuck
Range: 0-255 PSI. Resolution of 0.1 PSI, kPa (0-1800), kg/cm² (0-18), and Bar (0-18).
Digital backlit display. Includes lock-on chuck. Batteries included.
Durable 20" rubber air hose.
Sale \$100.94 **Tool Club \$80.75**

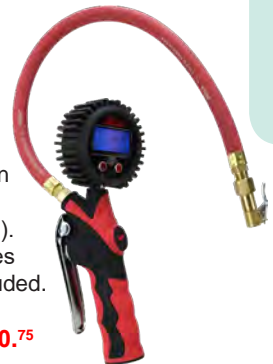

TIT19347
Tire Inflator with Gauge
36" Long hose.
Straight-on dual foot chuck.
10-120 psi.
Sale \$74.94 **Tool Club \$59.95**



MIL501
Dual Head Straight Chuck Inflator Gauge
Includes 5' hose & deflator valve. 1/4" NPT inlet. Range: 10 - 160 PSI.
Full swivel chuck head.
Sale \$109.94 **Tool Club \$87.95**



MILS506
Dual Head Inflator
With 10 - 120 lb. gauge, 15" hose & swivel head.
Sale \$66.88
Tool Club \$53.50



MILS516
Straight Head Inflator
With lock-on threads, 15" hose, 10 - 120 lb. gauge & swivel head.
Sale \$74.38
Tool Club \$59.50





AIR HOSE REELS

LEGL8652FZ
3/8" x 100' FLEXZILLA
Manual Air Hose Reel
 3/8" NPT discharge hose.
 Working temp -40° to 150° F.
 Sale \$187.44 **Tool Club \$149.95**



LEGL8611FZ
3/8" x 50' FLEXZILLA
Automatic Air Hose Reel
 1/4" NPT discharge hose.
 Working temp -40° - 150° F.
 Metal latching pawl.
 5' long lead in hose.
 Sale \$349.94 **Tool Club \$279.95**



LEGL8250FZ
3/8" x 50' FLEXZILLA
Enclosed Air Hose Reel
 Auto retract/ latch mechanism.
 Swivel mounting bracket.
 Adjustable hose stopper.
 Hose locks automatically in 18" intervals.
 Sale \$181.88 **Tool Club \$145.50**



LCN83753
3/8" x 50' Automatic Air Hose Reel
 • All steel construction
 • Slotted mounting base
 • Spring powered automatic recoil
 • 8 position ratchet system
 • 5 position adjustable outlet arm
 Sale \$262.44 **Tool Club \$209.95**



LCN83754
1/2" x 50' Automatic Air Hose Reel
 Sale \$288.69 **Tool Club \$230.95**

• Dual arm frame prevents bending & distortion.
 • EPDM rubber air hose with Nylon braid reinforcement.

MIL2760-50D
3/8" x 50' Automatic Air Hose Reel
 Sale \$287.44 **Tool Club \$229.95**

MIL2780-50D
1/2" x 50' Automatic Air Hose Reel
 Sale \$324.94 **Tool Club \$259.95**



Premium hybrid PVC/RUBBER air hose with a 300 PSI RATING.
 Working temp -40°F - 150°F.



Part #	ID x Long	Sale	Club
LEG3825	3/8" x 25'	\$42.44	\$33.95
LEG3850	3/8" x 50'	\$62.44	\$49.95
LEG1225	1/2" x 25'	\$55.63	\$44.50
LEG1250	1/2" x 50'	\$94.38	\$75.50



Premium Red Rubber EPDM. Resistance to heat, ozone & abrasion.

Part #	ID x Long	Sale	Club
APA3825	3/8" x 25'	\$41.19	\$32.95
APA3850	3/8" x 50'	\$71.19	\$56.95
APA1225	1/2" x 25'	\$62.44	\$49.95
APA1250	1/2" x 50'	\$99.94	\$79.95



High strength
 400 PSI working pressure
 1600 PSI burst pressure
 Fitting pull pressure at 240 pounds
 Ergonomic handle grips on both ends
 Patented built-in swivels on both ends

Part #	ID x Long	Sale	Club
WHH02173825	3/8" x 25'	\$45.63	\$36.50
WHH02173850	3/8" x 50'	\$68.13	\$54.50
WHH02173800	1/2" x 25'	\$118.75	\$95.00



WHH-REEL3850
3/8" x 50' Air Hose Retractable Reel
 High strength.
 400 PSI working pressure.
 1600 PSI burst pressure.
 Fitting pull pressure at 240 pounds.
 Ergonomic handle grips on both ends.
 Patented built-in swivels on both ends.
 Sale \$170.63 **Tool Club \$136.50**



COX-P-LP-350
Performance Spring Driven
Hose Reel 3/8" x 50'
 Sale \$687.44 **Tool Club \$549.95**



COX-P-LP-450
Performance Spring Driven
Hose Reel 1/2" x 50'
 Sturdy single pedestal reel with space saving design facilitates workplace organization. Guide arm adjusts to wall, floor, vehicle & overhead positions. Professional grade heavy duty steel construction.
 Sale \$749.94 **Tool Club \$599.95**



WATER HOSE NOZZLES

TIT11090
Water Hose Nozzle
 Fireman style.
 Sale \$12.44 **Tool Club \$9.95**



TIT11091
Adjustable Water
Hose Nozzle
 Sale \$19.94 **Tool Club \$15.95**



LEGNFZG02-N
Flexzilla Pro Pistol Grip
Water Hose Nozzle
 Multiple Spray Patterns
 Sale \$58.69 **Tool Club \$46.95**



WATER HOSES



LEGHFZG550YW
5/8" x 50' Flexzilla Garden Hose
 All weather flexibility. Lays flat. Kink resistant inner core design. 150 PSI working pressure.
 Sale \$59.69 **Tool Club \$47.75**





AIR COMPRESSORS

DELIVERS NON-STOP PERFORMANCE!

CALL FOR BEST PRICE

GAS-POWERED

ROTARY SCREW

ELECTRIC START



All Compressors Include:

- Two Stage Cast Iron Pumps
- 175 PSI Operation
- Copper Intercooler

Features:

- 100% Cast-iron for durability
- 100% Continuous duty rating
- Designed to run during peak demand
- Two year pump warranty with purchase of start - up kit
- Nationwide service coverage

Part #	HP	Package Description	CFM @ 175 PSI	Tank Size	Voltage or Engine
IR2340L5-V	5	2 stage cast iron pump, finned copper intercooler	14.0	60 gallons	230V
IR7.5HPLOADED	7.5	Automatic drain, low oil level switch, aftercooler, 2 stage cast iron pump, copper intercooler (Deluxe)	24.0	80 gallons	220/230V
IR10HPLOADED	10	Automatic drain, low oil level switch, aftercooler, 2 stage cast iron pump, copper intercooler, magnetic starter (Deluxe), 175 PSI Operation	35.0	120 gallons	220/230V
IR13HPGASHONDA	13	2 stage cast iron pump, copper intercooler	25.0	30 gallons	13HPGAS

IROILKIT
Electric Compressor Oil Kit
Sale \$224.94
Tool Club \$179.95



IROILMULTIG
Gas Compressor Oil Kit
Sale \$337.44
Tool Club \$269.95



MIL1002-32
Air Compressor Oil
Quart
Sale \$22.44
Tool Club \$17.95



MIL1002
Air Compressor Oil - Gallon
Sale \$46.19
Tool Club \$36.95



WILW60402
Tire Inflator w/LED
100 PSI high pressure air compressor.
15" high pressure hose with screw on chuck.
10' power cord with fused 12V power plug.
Sale \$37.44 **Tool Club \$29.95**

QUIET COMPRESSORS

FEATURES:

- Quiet Technology - low RPM pumps and motors that reduce high frequency noise levels
- Silencer - noise suppression system
- Cool Flow Technology
- Timed Water Drain
- Airstream spacing
- Continuous run (Dual control)
- Totally enclosed fan cooled motor
- Includes 1 year warranty
- Additional warranties available for purchase

NEW!



Part #	HP	Tank Size	Sale	Club
LEGFS505V080I1	5	80 gallons	\$5,623.75	\$4,499.00
LEGFXS07V080V1	7.5	80 gallons	\$6,249.94	\$4,999.95
LEGFXS10V080V1	10	80 gallons	\$7,123.75	\$5,699.00
LEGFXS10V120V1	10	120 gallons	\$8,123.75	\$6,499.00

PORTABLE COMPRESSORS



IRP1.5IU-A9
20 Gallon Portable
Electric Air Compressor
Heavy-duty ergonomic handle and semi-pneumatic tires for easy handling, ideal for DIYers or the professional.
Sound Level 80 dB
Sale \$1,312.44
Tool Club \$1,049.95



LEGCB20200F
20 Gallon Portable
Electric Air Compressor
2 HP. 125 Max PSI.
Quiet Technology™.
Industrial Grade Pump. Front mounted controls. Manual tank drain. 8" over-sized wheels. 6' power cord.
Sale \$849.94
Tool Club \$679.95



3/8" IMPACT

IR15QMAX
3/8" Quiet
Ultra-Compact Impactool
475 ft/lbs nut busting torque.
Weighs 2.4 lbs. Quiet
technology. Only 4.6" long!
Sale \$231.19
Tool Club \$184.95



ACA1059-VXL
3/8" Vibrotherm Drive
Compact Impact Wrench
950 ft/lbs of max torque.
1,300 ft/lbs of loosening torque.
New Impact Mechanism
reduces vibration by 30%.
Weighs 2.8 lbs.
Sale \$212.44
Tool Club \$169.95



ACA1300-TH-A
3/8" Impact Wrench
500 ft/lbs nut busting
torque. 450 ft/lbs max
torque. Composite housing.
Sale \$237.44
Tool Club \$189.95



1/2" IMPACT

IR THE NEW
2235 SERIES!

IR36MAX
1/2" Ultra-Compact
Impactool
625 ft/lbs nut busting torque.
450 ft/lbs of max torque.
Weighs 2.4 lbs. Only 4.6"
long for tight areas!
Sale \$249.94
Tool Club \$199.95



IR2235TiMAX
1/2" Titanium
Impact Wrench
1,350 ft/lbs of nut-busting torque.
Weighs only 4.6 lbs!
Sale \$462.44
Tool Club \$369.95



ACA1058-VXL
1/2" Vibrotherm Drive
Compact Impact Wrench
500 ft/lbs of max torque.
Weighs 2.8 lbs. New Impact
Mechanism recudes vibration
by 30% & increases life by 50%.
Sale \$212.44
Tool Club \$169.95



IR2235TiMAX-G
1/2" Titanium
Impact Wrench
1,350 ft/lbs of nut-busting torque.
Weighs only 4.6 lbs!
Sale \$468.69
Tool Club \$374.95



IR231C
1/2" "The Classic"
Super Duty Impact
500 ft/lbs torque forward
600 ft/lbs reverse.
Sale \$199.94
Tool Club \$159.95



IR2235TiMAX-R
1/2" Titanium
Impact Wrench
1,350 ft/lbs of nut-busting torque.
Weighs only 4.6 lbs!
Sale \$468.69
Tool Club \$374.95



CORDLESS TOOLS

1/2"



IRW7152-K22
1/2" IQv20 Impact Wrench Kit
with (2) Batteries, Charger and Tool Bag
• Includes (2) 20V 5.0 aH batteries
• Nut-Busting Torque: 1,500 ft/lbs
• Weight: 7.6 lbs
Sale \$762.44 **Tool Club \$609.95**



ACA1125
1/2" Composite
Impact Wrench
rovides 1,250 ft-lb
of loosening torque.
Quiet tuned exhaust (86 dBA)
Sale \$262.44
Tool Club \$209.95



IR2235TiMAX-O
1/2" Titanium
Impact Wrench
1,350 ft/lbs of nut-busting torque.
Weighs only 4.6 lbs!
Sale \$468.69
Tool Club \$374.95



CPT7748
1/2" Composite
Impact Wrench
Provides 1,300 ft-lb
of loosening torque.
Lightweight 4.65 lbs
One-hand reverse system
Ring system for better ergonomics
Sale \$262.44
Tool Club \$209.95



IR2235QTiMAX
1/2" "Quiet" Titanium
Impact Wrench
Sound reducing design.
1300 ft/lbs.
Sale \$462.44
Tool Club \$369.95



CPT7741-2
1/2" Composite
Impact Wrench
2" extended anvil Twin Hammer,
Max Torque Output 715 ft
Sale \$199.94
Tool Club \$159.95



IR2235TiMAX-2
1/2" Extended
Titanium Impact
Wrench
2" extended anvil.
Sale \$468.69
Tool Club \$374.95



IRW9691-K4E
1" Extended Anvil IQv20 Impact Wrench Kit
• 3,000 ft/lbs of nut busting torque
• Brushless motor
• Two (2) batteries operate the gun
• Three (3) torque settings
• 360° adjustable D-Handle.
• Includes 1 Dual Bay Charger &
(4) BL2022 batteries
Sale \$1,962.44 **Tool Club \$1,569.95**



CPT7741
1/2" Composite
Impact Wrench
Twin Hammer,
Max Torque Output 715 ft
Sale \$187.44
Tool Club \$149.95



IR2135QXPA
1/2" Air Impact Wrench
1,100 ft/lbs of max torque.
4 lbs. Quiet technology.
Sale \$337.44
Tool Club \$269.95



3/4" IMPACT



ACA1600-TH-A
3/4" Super Duty Impact Wrench
 1,600 ft/lbs of max torque.
 Hard hitting "Super Clutch"
 Sale \$499.94
Tool Club \$399.95



IR2146QIMAX
3/4" HD Impact Gun
 2,000 ft-lbs Nut-busting torque.
 Pressure gauge improves productivity
 Twin hammer, 7.8Lbs
 Sale \$874.94
Tool Club \$699.95



IR261
3/4" H.D. Impact
 1,200 max ft/lbs torque.
 Sale \$699.94
Tool Club \$559.95



Part #	Anvil	Torque	Sale	Club
IR261	1,200	\$699.94	\$559.95	
IR261-3	3"	1,200	\$787.44	\$629.95
IR261-6	6"	1,200	\$837.44	\$669.95



CP7763D-6
3/4" Impact Gun 6" Ext- D Handle
 1,300 FtLbs of HD torque. 16.Lbs D- Handle
 Sale \$674.94 **Tool Club \$539.95**



1" IMPACT

IR295A
1" Air Impact Wrench
 Max Torque: 1,450ft/lbs
 Deliver Fast Torque
 at 1,000ft/lbs in 2 seconds
 Sale \$962.44
Tool Club \$769.95



IR2175MAX
1" Impact Wrench
 Max Torque: 2,000 ft/lbs
 Steel core design lasts longer
 Sale \$962.44
Tool Club \$769.95



IR285B-6
1" Impact
 Features 6" extended anvil.
 1,475 max ft/lbs torque.
 Sale \$787.44 **Tool Club \$629.95**



IR2850MAX
1" Titanium Impact Wrench
 "D" handle. Stubby
 Max Reverse Torque: 2,100 ft/lbs.
 Free Speed: 5,500 RPM. 13.1" long.
 Steel core design. 25% lighter than industry's
 leading 1" wrench. 360° adjustable handle.
 Sale \$924.94 **Tool Club \$739.95**



IR2850MAX-6
1" Titanium Impact
 "D" handle. 6" extended anvil.
 Max Reverse Torque: 2,100 ft/lbs.
 Free Speed: 5,500 RPM. 19.1" long.
 Steel core design. 25% lighter than industry's
 leading 1" wrench. 360° adjustable handle.
 Sale \$962.44 **Tool Club \$769.95**



ACA1993-VXL
1" Vibrotherm Dr. Impact Wrench w/ 7" Anvil
 Provides 2,100 ft-lbs Max Torque. 2,300 ft-lbs of
 loosening torque. VIBROTHERM DRIVE®
 impact wrenches incorporates the new patented
 AIRCAT® design impact wrench mechanism.
 6,000 RPM Free Speed.
 Sale \$749.94 **Tool Club \$599.95**



1/4" RATCHETS



IR1105MAX-D2
1/4" Composite Slim Head
 Max Torque: 30 ft/lbs.
 Free Speed: 300 RPM.
 Sale \$205.63 **Tool Club \$164.50**



ACA800R
1/4" Composite Air Ratchet
 Max Torque: 45 ft/lbs. Free Speed: 320 RPM.
 Feather trigger for control. Strongest 1/4"
 ratchet in it's class!
 Sale \$116.88 **Tool Club \$93.50**



ACA808-15-25
1/4" Dr. 15.3" Long Reach Ratchet
 30 ft-lb Maximum torque (15.3" long).
 Extended drive shafts provide access for hard to
 reach fasteners. High grade materials and
 additional support bearings provide reliability
 Sale \$149.94 **Tool Club \$119.95**



3/8" RATCHETS

IR1105MAX-D3
3/8" Titanium Slim Head
 Max Torque: 30 ft/lbs.
 Free Speed: 300 RPM.
 Sale \$218.69 **Tool Club \$174.95**



IR107XPA
3/8" Air Ratchet
 Max Torque: 54 ft/lbs. Free Speed: 160 RPM.
 11" long. Variable speed throttle.
 Sale \$147.81 **Tool Club \$118.25**



IR1211MAX-D3
3/8 HD Air Ratchert
 80 ft-lbs. of torque from reactionless High
 Speed 625 RPM Free Speed
 Sale \$287.44 **Tool Club \$229.95**



ACA802R
3/8" Composite Ratchet
 Max Torque: 70 ft-lbs. Free Speed: 280 RPM.
 Feather Trigger for control. Patented quiet tuned
 exhaust at only 82dBa.
 Sale \$124.94 **Tool Club \$99.95**



ACA808-15
3/8" Dr. 15.3" Long Reach Ratchet
 30 ft-lb Maximum torque (15.3" long).
 Extended drive shafts provide access for hard to
 reach fasteners. High grade materials and
 additional support bearings provide reliability
 Sale \$149.94 **Tool Club \$119.95**



IMPACT RATCHETS

AST1833
3/8" Nano Flex-Head Angle Impact Wrench
 Max Torque: 400ft/lbs.
 180° flex-head w/ 360° swivel handle.
 Sale \$216.88 **Tool Club \$173.50**



AST1834
1/2" Nano Flex-Head Angle Impact Wrench
 Max Torque: 400ft/lbs.
 180° flex-head w/ 360° swivel handle.
 Sale \$216.88 **Tool Club \$173.50**



CUTTING TOOLS

SPA7231R

3" Reversible Flex Head Cut-Off Tool
3 position locking flexible head. Reversible throws sparks downward. 12,000 RPM. 8.8" long. Sale \$230.31



Tool Club \$184.25

AST209

ONYX In-Line 3" Cut-Off Tool
15,000 RPM. Sale \$114.38



Tool Club \$91.50

IR326

Cut Off Tool
18,000 RPM. Sale \$90.63



Tool Club \$72.50

IR426

3" Reversible Cut Off Tool
20,000 RPM and only 2 lbs! Sale \$156.19



Tool Club \$124.95

ACA6275-A

4" Composite Inside Cut-Off Tool
14,000 RPM. 11 position rotational guard. Sale \$274.94



AIR SAWS

SPA7610

Air Recipro Saw
Motor driven saw with a powerful stroke. 5,300 strokes per minute. Stroke: 0.47". Sale \$262.44



IR529

Low Vibration \ Air Reciprocating Saw
Small & lightweight design. Adjustable rear exhaust. Sale \$249.94



Includes: **3 fine & 3 coarse tooth blades**

IR429

Air Saw
10,000 Strokes/min. Includes 6 Blades. Sale \$162.44



ACA6355

Universal Blade Air Saw
5,000 SPM. Accepts any saw blade, including "Sawzall" type blades. Can cut up to 1/4" steel or 3" steel pipe. Dual Speed Design. Rear Exhaust. Sale \$237.44



SANDERS & POLISHERS

IR4151

6" Super Duty Dual Action Sander
12,000 RPM. Sale \$218.69



Tool Club \$174.95

IR311A

6" Geared Orbital Sander
12,000 RPM. Built-in silencer. Sale \$111.19



Tool Club \$88.95

IR328B

8" Dual Action Sander
825 RPM. Sale \$212.44



Tool Club \$169.95

TIT19225

6" Orbital Palm Sander
For fine finishing. Sale \$93.69



Tool Club \$74.95

AST322P

6" Finishing Palm Sander
High power. 3/16" stroke. Orbital action. Sale \$121.19



Tool Club \$96.95

ACA6700-6-336-PSA

6" Orbital Palm Sander
Lubrication free air motor. Double sealed motor to prevent dust contamination. Anti-Vibration motor design reduces vibration level to 0.8m/sec². Sale \$174.94



Tool Club \$139.95



IR315

Straight Line Sander
3,000 strokes per minute. Sale \$181.19

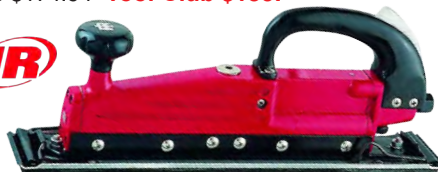

SHEARS

IR7802SA

Air Shear
Cuts up to 20 gauge without chips. Shears plastics, aluminum, tin & steel. Sale \$268.69



Tool Club \$214.95

AIR GRINDER

IR3445MAX

4.5" Wheel HD Air Angle Grinder
MAX Power: 0.88 horsepower motor 12,000 RPM. Weighs only 3.5lbs! Sale \$374.94



Tool Club \$299.95

ACA6320

Spot Sander
13,000 RPM Only 1lb! Sale \$172.44



Tool Club \$137.95



IR360-313

3/8" Pneumatic Belt Sanders
3/8" x 13" 0.6HP motor Sale \$174.94



Tool Club \$139.95



IR360-418

1/2" Pneumatic Belt Sanders
1/2" x 18" Air Belt Sander 0.6HP motor 1900 RPM Sale \$199.94



Tool Club \$159.95



IR320PGK

Air Pencil Grinder Kit
5 assorted mounted points & 5 assorted carbide burrs in a hard case Sale \$262.44



Tool Club \$209.95



IR140EP

Pneumatic Engraving Pen
Engrave many different applications and surfaces makes it one of the most versatile tools. Sale \$199.94



Tool Club \$159.95

3/8" AIR DRILLS



IR7802RA
3/8" Reversible HD Air Drill
 2,000 RPM. Only 2.5lbs! Quick reverse level, variable speed throttle. Handles smoothly.
 Sale \$207.44 **Tool Club \$165.95**



AST525C
3/8" Reversible Air Drill
 Lightweight - 2.5lbs. Built-in muffler. 90-120PSI.
 Sale \$65.31 **Tool Club \$52.25**



IR7807R
3/8" Reversible Angle Drill
 1,800 RPM; Angled for hard to reach places.
 Sale \$149.94 **Tool Club \$119.95**



AST510AHT
3/8" Reversible Angle Drill
 For hard to reach places. 1,800 RPM. 2 gear drive system.
 Sale \$104.94 **Tool Club \$83.95**

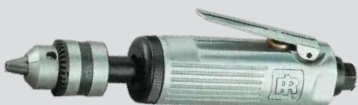

IR327
3/8" Air Drill - Tire Buffer
 Extra high speed - 22,000 RPM. For recapping, tire scuffing and cleaning tire moldings.
 Sale \$121.19 **Tool Club \$96.95**

1/2" AIR DRILLS



IR7803RA
1/2" Reversible Air Drill
 400 RPM. 4CFM Average Air Consumption. Only 3.3lbs!
 Sale \$299.94 **Tool Club \$239.95**



Side Handle for Greater Control

AST527C
1/2" Reversible Air Drill
 Variable Speed up to 500 RPM. 9-1/4" Length. 7CFM Average Air Consumption. 90-120 PSI.
 Sale \$104.94 **Tool Club \$83.95**



DIE GRINDERS

IR5102MAX
Angle Die Grinder
 0.4 HP air motor. 20,000 RPM free speed. Multi-position head. Spindle lock.
 Sale \$237.44 **Tool Club \$189.95**



ACA6295
115° Angle Die Grinder
 0.6 HP air motor. 18,000 RPM free speed. Spindle lock. Speed Control.
 Sale \$137.44 **Tool Club \$109.95**



IR308B
H. D. Die Grinder
 25,000 RPM free speed.
 Sale \$106.88 **Tool Club \$85.50**



IR307B
Mini Die Grinder
 27,000 RPM free speed.
 Sale \$78.13 **Tool Club \$62.50**



IR302B
H. D. Angle Die Grinder
 18,000 RPM free speed.
 Sale \$156.19 **Tool Club \$124.95**



IR301B
Angle Die Grinder
 20,000 RPM free speed.
 Sale \$93.13 **Tool Club \$74.50**



ACA6210
1/4" Extended Straight Die Grinder
 22,000 RPM free speed.
 Sale \$187.44 **Tool Club \$149.95**



DIE GRINDER KITS



IR301B2MK
Kit for Surface Conditioning
 Includes: #301 angle die grinder, 2" & 3" abrasive discs plus holders.
 Sale \$174.94 **Tool Club \$139.95**



AST1221
Die Grinder Kit & 8pc. Rotary Burr Set
 1/4" 90 Degree Angle Die Grinder (20,000RPM) & 1/4" Mini Die Grinder, (25,000RPM). 8pc. double cut carbide rotary burr set with 1/4" shank.
 Sale \$149.94 **Tool Club \$119.95**



ACCESSORIES

3" CUT OFF WHEELS

Part #	Pcs.	Club
SH12704	10	\$21.95
SH13215	100	\$92.95
TA94860	5	\$11.95
TA94890	100	\$132.50



AIR SAW BLADES

NARROW - PACK OF 5



Part #	Lgth.	Teeth	Sale	Club
TA90000	3"	18 T.P.I.	\$18.69	\$14.95
TA90020	3"	24 T.P.I.	\$18.69	\$14.95
TA90030	3"	32 T.P.I.	\$18.69	\$14.95

ALL PURPOSE - PACK OF 5



Part #	Lgth.	Teeth	Sale	Club
TA90010	4"	18 T.P.I.	\$18.69	\$14.95
TA90040	4"	32 T.P.I.	\$18.69	\$14.95

TA94950
Arbor for Cut Off Wheels
 Sale \$10.63 **Tool Club \$8.50**



SH13056
2" Mini Zirconia Flap Discs
 6 Pack
 Sale \$40.94 **Tool Club \$32.75**



SH7000
Flap Wheel Kit - 8 Pieces
 Sale \$45.31 **Tool Club \$36.25**



SH13092
4.5" Diamond Cut-Off Wheels
 Sale \$42.44 **Tool Club \$33.95**



ABRASIVE DISCS

Part #	Grit	Club	TWIST-LOCK BAG OF 25
SH620T	2" Coarse	\$23.25	
SH622T	2" Medium	\$23.25	
SH624T	2" Fine	\$23.25	
SH630T	3" Coarse	\$35.50	
SH632T	3" Medium	\$35.50	



HOLDERS

Part #	Size	Club
SH13012	2" Holder	\$10.75
SH13013	3" Holder	\$12.50



SANDING PADS

Part #	Grit	Club	BAG OF 25
SH13226	2" Coarse - 24	\$24.50	
SH13227	2" Medium - 36	\$24.50	



AIR HAMMERS

IR117K

Air Hammer Kit

Includes 5 chisels.
Up to 2,000 blows per minute.
Longer stroke piston.
Kit includes edging tool, tail pipe cutter, straight chisel, cutting chisel, and punch.
Sale \$112.44 **Tool Club \$89.95**



IR121-K6

H. D. Air Hammer Kit

Includes 6 chisels.
Professional touch trigger.
Up to 3,000 blows per minute.
Include blow molded storage case.
Sale \$174.94 **Tool Club \$139.95**



ACA5100A

Composite Medium Stroke Air Hammer Kit

3,000 Blows Per Minute.
Includes H.D. ball-lock quick change chisel retainer, 5 chisels & blow molded case.
Sale \$199.94 **Tool Club \$159.95**



IR119MAXX

Long Barrel Air Hammer Kit

Includes 5 chisels.
Quick change retainer.
2,530 blows per minute.
Anti-vibration technology.
Includes carrying case.
Sale \$224.94 **Tool Club \$179.95**



IR123MAXX

Short Barrel Air Hammer Kit

Includes 5 chisels. Quick change retainer.
3,530 blows per minute. Great for exhaust, front end jobs, general bolt cutting, pin driving, and body shearing work.
Sale \$229.38 **Tool Club \$183.50**



IR135MAXX

Max Heavy Duty Air Hammer

Includes 5 chisels. Quick change retainer.
2600 blow per minute action
Sale \$349.94 **Tool Club \$279.95**



LIS41440

5pc Stepped Pickle Fork Kit

Sizes: 11/16"-1-5/8". Forks can be used with an dle or air hammer.
Sale \$131.19 **Tool Club \$104.95**

AIR HAMMER ACCESSORIES

TA94400 Retainer

Fits IR117 & all CP except #716.
Sale \$33.69
Tool Club \$26.95



TA94450 Retainer

Fits IR121 & CP716.
Sale \$33.69
Tool Club \$26.95



STK71415 Axle Popper II

The air tool version of the popular Axle Popper, breaks loose half shafts from transaxle on front wheel drive vehicles. Tapered on both ends of the wedge along with a 6" shaft to fit an air hammer.
Sale \$81.19 **Tool Club \$64.95**



MAY31940

5pc Pneumatic Separating Fork Set

Handles ball joints with minimal shock to the assembly. .401 shank.
11/16", 15/16", 1-11/16", 1-3/8", 1-1/8".
Sale \$178.69 **Tool Club \$142.95**

MAY37323

3pc Long Pneumatic Tool Set

Black oxide finish. Extra long body for hard-to-reach areas. Includes long scraper, long taper punch, and sharp point long taper punch.
Sale \$107.19 **Tool Club \$85.75**



MAY32030

5pc Pneumatic Sets Head Riveter

6" standard .401 shank size.
Sale \$99.94 **Tool Club \$79.95**



LIS41400

Stepped Pickle Fork Kit

Design helps keep tool from bouncing back.
Sale \$74.38 **Tool Club \$59.50**



MAY37315

3/8" Shake n Break

Sale \$19.94
Tool Club \$15.95



MAY37316

1/2" Shake n Break

Sale \$24.94
Tool Club \$19.95



MAY32025

4pc Pneumatic Hammer Set

Sizes: 1" x 8", 1" x 1-1/4", 1" x 6" & 1" x 12". Standard .401 turn type. Shanks for air guns.
Sale \$117.44 **Tool Club \$93.95**

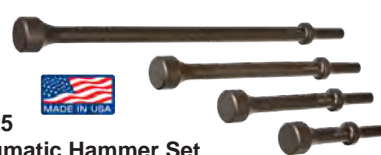

.498

GYCS807

7pc H.D. Chisel Set

Set Includes: 5/8" flat chisel, tapered punch, straight punch, dual blade panel cutter, rivet cutter, 1-1/4" diameter hammer, & bushing splitter.
Sale \$104.94 **Tool Club \$83.95**



CTA1000

VibroShock Impact Tool Kit

7 Metric Impact Sockets - 8, 9, 10, 11, 12, 13, 14mm. All 3/8" square drive & all with "Internal Edge"
Sale \$106.19 **Tool Club \$84.95**



LIS29450

Short Anchor Pin Bushing Driver

7" Drive for limited access. Removes & installs truck & trailer 1-3/8" anchor pin bushings and stuck anchor pins. Also removes truck leaf spring bushings.
Sale \$65.56 **Tool Club \$52.45**





IRG5351-K22
Cordless Angle Grinder Kit
 Cordless 4.5/5.0" Angle Grinder & Cut-Off Tool that brings the power of pneumatic with the mobility of a cordless tool. Slim and well-balanced. Includes grinder Charger and 2 5.0amp Batteries.
 Sale \$562.44 **Tool Club \$449.95**



IRW7152-K22
1/2" IQv20 Impact Wrench Kit
 with (2) Batteries, Charger and Tool Bag
 • Includes (2) 20V 5.0 aH batteries
 • Nut-Busting Torque: 1,500 ft/lbs
 • Weight: 7.6 lbs
 Sale \$762.44 **Tool Club \$609.95**



IRW7172-K22
3/4" Dr. 20V Brushless High Impact Wrench w/ (2) Batteries Kit
 • Nut Busting Torque: 1,500 ft/lbs
 • Max Torque: 1,000 ft/lbs
 Sale \$849.94 **Tool Club \$679.95**

IRG5351-20V
Cordless Angle Grinder BARE TOOL ONLY
 Sale \$312.44 **Tool Club \$249.95**

IRW7152
1/2" Drive IQv20 Brushless Impactool - BARE TOOL ONLY
 Sale \$462.44 **Tool Club \$369.95**

IRW7172
3/4" Drive 20V Brushless Impactool - BARE TOOL ONLY
 Sale \$537.44 **Tool Club \$429.95**

IRW9691-K4E
1" Extended Anvil IQv20 Impact Wrench Kit
 • 3,000 ft/lbs of nut busting torque
 • Brushless motor
 • Two (2) batteries operate the gun at the same time!
 • Three (3) torque settings
 • 360° adjustable D-Handle.
 • Includes 1 Dual Bay Charger & (4) BL2022 batteries
 Sale \$1,962.44 **Tool Club \$1,569.95**



IRW9691
1" Extended Anvil IQv20 Impact Wrench - TOOL ONLY
 Sale \$1,249.94 **Tool Club \$999.95**



3/4" CORDLESS

MLW2864-22
M18 FUEL™ 3/4" High Torque Impact Wrench with ONE-KEY™ Kit
 Includes Tool, (2) XC5.0 Extended Capacity Batteries, M18 & M12 Multi-Voltage Charger & Carrying Case
 Sale \$862.44 **Tool Club \$689.95**



1" CORDLESS

MLW2867-22
M18 FUEL™ 1" High Torque Impact Wrench with ONE-KEY™ Kit
 Includes tool, (2) CX8.0 Batteries, M18 & M12 Rapid Charger & Contractor Bag
 Sale \$1,462.44 **Tool Club \$1,169.95**



MLW2864-20
M18 FUEL™ 3/4" High Torque Impact Wrench with ONE-KEY™ TOOL ONLY
 Up to 1,500ft-lbs Nut-Busting Torque. 1,200ft-lbs of fastening torque.
 Sale \$487.44 **Tool Club \$389.95**



MLW2867-20
M18 FUEL™ 1" High Torque Impact Wrench with ONE-KEY™ — TOOL ONLY
 1,800 ft-lbs Nut-Busting Torque. 1,500 ft-lbs of fastening torque.
 Sale \$1,062.44 **Tool Club \$849.95**



1" CORDLESS

MLW2868-22HD
M18 FUEL™ 1" D-Handle High Torque Impact Wrench Kit
 2,000 ft-lbs nut-busting torque. 1,900 ft-lbs of fastening torque. Up to 200 bolts per charge. Includes tool, High Output HD12.0 battery pack and M18™ & M12™ Rapid Charger.
 Sale \$1,974.94 **Tool Club \$1,579.95**



MLW2869-22HD
M18 FUEL™ 1" D-Handle Ext. Anvil High Torque Impact Wrench Kit
 2,000 ft-lbs nut busting torque. 1,900 ft-lbs of fastening torque. Lug-Nut mode prevents over-torque. Includes tool, (2) High Output HD12.0 Battery packs, M18 & M12 Rapid Charger, Tool-Free Adjustable Handle, Lanyard Loop and Carrying Case
 Sale \$1,974.94 **Tool Club \$1,579.95**



DRILLS



MLW2903-22
M18 FUEL 1/2" Drill Driver Kit
 1,200 in.-lbs of torque & 2,100 RPM.
 The REDLINK PLUS™ intelligence ensures maximum performance and protects from overloads, heating or over-discharge.
 Sale \$456.19 **Tool Club \$364.95**

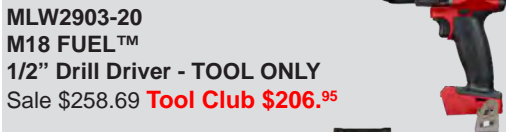

MLW2903-20
M18 FUEL™
1/2" Drill Driver - TOOL ONLY
 Sale \$258.69 **Tool Club \$206.95**



MLW3699-22
M18 FUEL
Cordless
Surge Impact
Hammer Drill
Combo Kit
 2-Tools
 2-Batteries, charger and case
 Sale \$687.44 **Tool Club \$549.95**



MLW2953-22
M18 FUEL™ Hex
Impact Driver Kit
 2,000 in.-lbs of Max Torque.
 3,600 RPM. 4-Mode Drive Control.
 Includes tool, (2) M18 REDLITHIUM CP2.0 batteries, (1) M18 & M12 Multi-Voltage Charger, Bit Holder & Carrying Case.
 Sale \$487.44 **Tool Club \$389.95**

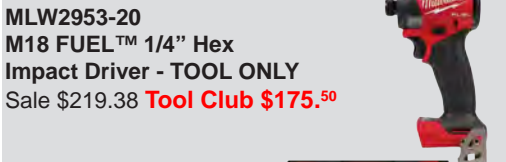

MLW2953-20
M18 FUEL™ 1/4" Hex
Impact Driver - TOOL ONLY
 Sale \$219.38 **Tool Club \$175.50**



MLW3497-22
M12 FUEL
2pc Kit -
1/2" Drill & 1/4" Hex Impact
 1/2" Drill: 1,700 RPM & 350in.-lbs. of torque. 1/4" Hex Impact: 3,300 PRM w/ 4-Mode Drive Control.
 Sale \$361.19 **Tool Club \$288.95**



Part #	Model	Amps	Sale	Club
MLW48-11-2412	M12	3.0	\$187.44	\$149.95
MLW48-11-2460	M12	6.0	\$171.19	\$136.95
MLW48-11-1820P	M18	2.0	\$137.44	\$109.95
MLW48-11-1850	M18	5.0	\$224.94	\$179.95
MLW48-11-1880	M18	8.0	\$293.13	\$234.50



MLW2475-21XC
M12™ Compact Inflator Kit
 Fastest Cordless Tire Inflator.
 120 max PSI. 26" hose.
 Includes Inflator, Battery Pack & Battery Charger.
 Sale \$249.94 **Tool Club \$199.95**



MLW2475-20
M12™ Compact Inflator - TOOL ONLY
 Sale \$174.94 **Tool Club \$139.95**



MLW2848-20
M18 Tire Inflator
 Top off 33" light truck tires in under 1 minute.
 Rated for 150 PSI max.
 PSI Memory Preset.
 Truefill™ Technology. On-Board hose & Nozzle Storage. Anti-Vibration Feet.
 Sale \$231.19 **Tool Club \$184.95**



MLW2438-22X
M12 Variable Speed Polisher / Sander w/ 5pc Accessory Kit
 Polishing Mode: 0 - 2800 RPM.
 Sanding Mode: 0 - 300 RPM. Variable speed trigger.
 Includes 12v battery, extended battery, charger, pads, & carrying case.
 Sale \$312.44 **Tool Club \$249.95**



MLW2488-21
M12™ Soldering Iron Kit
 Includes M12™ tool, 1 chisel tip, 1 pointed tip, 1 M12™ REDLITHIUM compact battery pack, 1 M12™ charger and carrying case.
 18 second heat up time. Tool-free tip changing. Red LED indicates tool is off and still hot.
 Sale \$205.63 **Tool Club \$164.50**



MLW0820-20
M12 12-Volt Cordless Jobsite Fan (Tool-Only)
 Sale \$124.94 **Tool Club \$99.95**



MLW0886-20
M18 18-Volt Cordless Jobsite Fan (Tool-Only)
 Sale \$131.19 **Tool Club \$104.95**



MLW48-29-1807
M12 and M18 Multi-Voltage 6-Port Sequential Rapid Battery Charger (3 M12 and 3 M18 Ports)
 Sale \$212.44 **Tool Club \$169.95**



MLW2522-21XC
M12 FUEL 3" Compact Cut Off Tool Kit
 20,000 RPM. Optimized for one-handed use. Bi-directional blade rotation.
 Includes a tool free guard and shoe that includes a vacuum adapter for dust mitigation as well as cut depth adjustment.
 Sale \$299.94 **Tool Club \$239.95**



MLW2522-20
M12 FUEL™
3" Compact Cut Off Tool - TOOL ONLY
 Sale \$205.63 **Tool Club \$164.50**



MLW2485-22
M12 FUEL™
1/4" Right Angle Die Grinder Kit
 0.3 HP Motor Output. 4-Mode speed control. 20% more power than pneumatic. M12 RED LITHIUM Battery Technology. Includes 2 batteries.
 Sale \$412.44 **Tool Club \$329.95**

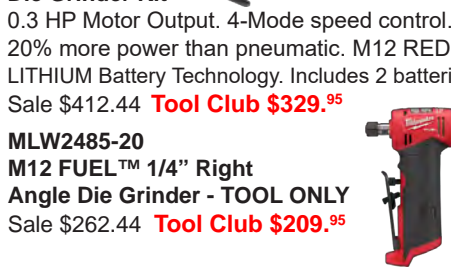

MLW2485-20
M12 FUEL™ 1/4" Right Angle Die Grinder - TOOL ONLY
 Sale \$262.44 **Tool Club \$209.95**



MLW2486-22
M12 FUEL™ 1/4" Straight Die Grinder Kit
 0.3 HP Motor Output. 3-Mode Speed Control. 20% more power than pneumatic. Includes Tool, (2) M12 REDLITHIUM CP2.0 Batteries, (1) M12 Li-Ion Battery Charger, Carrying Case & wrenches.
 Sale \$424.94 **Tool Club \$339.95**



MLW2486-20
M12 FUEL™
1/4" Straight Die Grinder - TOOL ONLY
 Sale \$262.44 **Tool Club \$209.95**



MLW2460-21
M12™ Rotary Tool Kit
 5,000 -32,000RPM. Variable-Speed dial. 1/32" - 1/8" shank. Compact, Lightweight design. 1 12v Battery and M12 Charger.
 Sale \$188.13 **Tool Club \$150.50**

MLW2554-22
M12 FUEL™
3/8" Stubby
Impact Wrench Kit
 250 ft-lbs of nut-busting torque. Brushless Motor. 4.8" long. 4-mode drive control. Includes tool, (1) CP2.0 battery, (1) XC 4.0 Extended (1) M12™ Battery charger, (1) carrying case.
 Sale \$437.44 **Tool Club \$349.95**



MLW2988-22R
M18 FUEL 3/8" & 1/2" 2pc Combo Kit
 1/2" High Torque - 1,400 ft-lbs nut busting torque. 3/8" Mid-Torque - 600 ft-lbs nut busting torque. Includes (2) 5.0Ah Batteries, Charger, & Tool Bag.
 Sale \$924.94 **Tool Club \$739.95**



MLW2554-20
M12 FUEL™ 3/8" Stubby
Impact Wrench - TOOL ONLY
 250 ft-lbs of nut-busting torque. POWERSTATE™ Brushless Motor. 4.8" long. 4-mode drive control.
 Sale \$268.69 **Tool Club \$214.95**



MLW2555-22
M12 FUEL™ Stubby
1/2" Impact Wrench Kit
 250 ft-lbs nut busting torque. Only 4.9" long. 4-mode drive control. 2,700 RPM. Includes (1) M12 4.0Ah battery, (1) M12 2.0Ah battery, (1) M12 charger & carry case.
 Sale \$393.69 **Tool Club \$314.95**



MLW2767-22
M18 FUEL 1/2" High Torque Impact
Wrench w/ Friction Ring Kit
 1,400 ft-lbs of nut-busting torque. 1,000 ft-lbs of fastening torque. LED light to illuminate the work area. Includes impact tool, two(2) batteries, M18 & M12 Multi-Voltage charger & carrying case.
 Sale \$724.94 **Tool Club \$579.95**



MLW2555-20
M12 FUEL™ Stubby 1/2"
Impact Wrench - TOOL ONLY
 250 ft-lbs nut busting torque. 4.9" long. 4-mode drive control. 2,700 RPM.
 Sale \$237.44 **Tool Club \$189.95**



MLW2854-20
M18 3/8 in. Compact
Impact Gun (Tool-Only)
 4.9in Long. Brushless motor delivers up to 250 ft./lbs. of nut-busting torque.
 Sale \$306.88 **Tool Club \$245.50**



MLW2855-20
M18 1/2 in. Compact
Impact Gun (Tool-Only)
 4.9in Long. Brushless motor delivers up to 250 ft./lbs. of nut-busting torque.
 Sale \$306.88 **Tool Club \$245.50**



MLW2960-20
M18 3/8 in. Compact
Impact Gun (Tool-Only)
 6" Long. Brushless motor delivers up to 600 ft./lbs. of nut-busting torque.
 Sale \$331.19 **Tool Club \$264.95**



MLW2767-20
M18 FUEL 1/2" High
Torque Impact Wrench (Tool-Only)
 1,400 ft-lbs nut busting torque.
 Sale \$387.44 **Tool Club \$309.95**



RATCHETS

MLW2566-22
M12 FUEL 1/4" High Speed Ratchet Kit
 Up to 35 ft-lbs of max torque! Includes 2 12v battery, charger, & carry case.
 Sale \$398.69 **Tool Club \$318.95**



MLW2566-20
M12 FUEL 1/4" Ratchet (TOOL ONLY)
 Sale \$264.38 **Tool Club \$211.50**



MLW2567-22
M12 FUEL 3/8" High Speed Ratchet Kit
 Up to 35 ft/lbs of max torque! Includes 1 12v battery, charger, & carry case.
 Sale \$371.88 **Tool Club \$297.50**

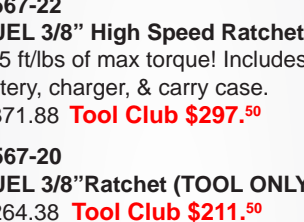

MLW2567-20
M12 FUEL 3/8" Ratchet (TOOL ONLY)
 Sale \$264.38 **Tool Club \$211.50**



MLW2568-20
M12 FUEL 12V 1/4 in. Extended Reach
High Speed Ratchet (Tool Only)
 10.25" Long Up to 35 ft/lbs of max torque!
 Sale \$437.44 **Tool Club \$349.95**



MLW2569-20
M12 FUEL 12V 3/8 in. Extended Reach
High Speed Ratchet (Tool Only)
 10.25" Long Up to 35 ft/lbs of max torque!
 Sale \$437.44 **Tool Club \$349.95**



MLW2569-21
M12 3/8" Long Ratchet Kit
 Up to 35 ft/lbs torque! Includes 1 12v battery, charger, & carry case.
 Sale \$437.44 **Tool Club \$349.95**



MLW2564-20
M12 FUEL™ 3/8" Right Angle
Impact (Tool Only)
 Sale \$299.38 **Tool Club \$239.50**



MLW2565-20
M12 FUEL™ 1/2" Right Angle
Impact (Tool Only)
 Sale \$276.88 **Tool Club \$221.50**

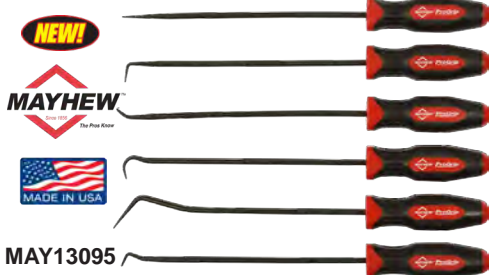

MAY13095
17-3/4" 6pc
ProGrip Long Pick Set
Includes Straight Pro, 90° Bend Pro, Compound Bend ProGrip x 14-3/4", Hook Pro, Offset Pro, & Dual Angle ProGrip x 14-3/4"
Sale \$118.13 **Tool Club \$94.50**



MAY60003
4pc MINI
Hook & Pick Set
6-1/2" long.
Sale \$22.81
Tool Club \$18.25



MAY13094
4pc ProGrip
Hook & Pick Set
Includes Straight Pick, Hook ProGrip, Dual Angle ProGrip, 90° Bend ProGrip
Sale \$73.69
Tool Club \$58.95



LIS80200
4pc Hose Remover Set
Long & short, standard & offset hooks.
13" Long pullers.
Sale \$39.38
Tool Club \$31.50



CLHP4A
4pc Mini
Hook & Pick Set
Includes: straight, 90° & 180° & complex picks. Useful on small fuses, wire plugs, and "O" rings.
Sale \$20.94
Tool Club \$16.75



WILW942
6pc Hook & Pick Set
Includes: straight, 90°, double angle, complex, combination pick and hook picks.
Sale \$9.94
Tool Club \$7.95



WILW948
9pc H.D.
Hook & Pick Set
4 mini and 4 full sized picks & 1" scraper.
Sale \$23.69
Tool Club \$18.95



MAYHEW
MAY17990
Long Hook & Pick Set
9-3/4" Long 8-Piece Hook & Pick Set
Sale \$32.44 **Tool Club \$25.95**

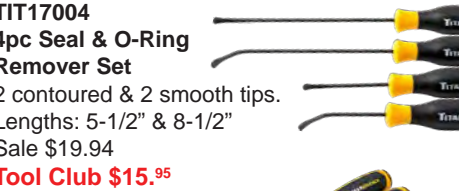

TIT17004
4pc Seal & O-Ring
Remover Set
2 contoured & 2 smooth tips.
Lengths: 5-1/2" & 8-1/2"
Sale \$19.94
Tool Club \$15.95



KDT84000H
7pc Hook & Pick Set
Variety of shapes to leverage or pull parts, springs & cotter pins
Sale \$48.44 **Tool Club \$38.75**

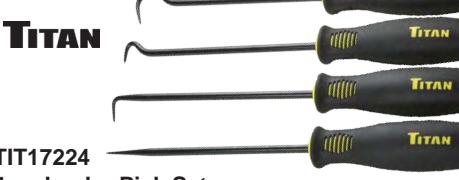

TITAN
TIT17224
4pc Jumbo Pick Set
10.5" Long w/metal shaft through handle.
Sale \$29.38 **Tool Club \$23.50**



TITAN
TIT17612
12pc MINI Pick & Screwdriver Set
Includes: 4 picks, Phillips: #00 & #000; Slotted: 3/32" & 1/8"; Torx: T5, T7, T8, & T10
Sale \$33.75 **Tool Club \$27.00**



LIS31800
Scribe
Sale \$7.81 **Tool Club \$6.25**



LIS31840
"O" Ring & Seal Pick
Sale \$7.81 **Tool Club \$6.25**



WILW1771
10pc Hook & Pick Set
Packaged in Jar for Maximize space comes with scraper and led magnetic pick up tool.
Sale \$24.94 **Tool Club \$19.95**



WILW15032
Jumbo 3x
Magnifying Glass
4-1/2" lens x 10" long.
Sale \$12.44
Tool Club \$9.95

H.D. SCRAPERS



MAYHEW
MAY14082
4pc Dominator
Straight Scraper Set
Sizes: 1/2", 3/4", 1" & 1-1/4"
Steel shaft goes through the handle. Capped end handle for striking.
Sale \$112.44 **Tool Club \$89.95**



EZRMS400
4" Mini Scraper
Scrape in the tightest spaces.
Sale \$7.44 **Tool Club \$5.95**



EZRMS600
6" Razer Scraper
6" long handle with vinyl grip & angled head.
Sale \$8.13 **Tool Club \$6.50**



EZRMS1900
19" Monster Scraper
Aluminum body stores 15 blades.
Sale \$21.56 **Tool Club \$17.25**

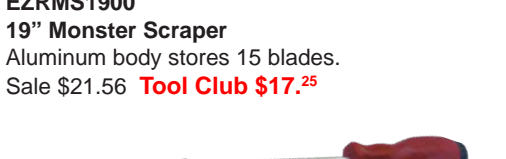

LIS52000
X-Long
Inspection Scraper
Sale \$15.31
Tool Club \$12.25



TITAN
TIT17008
22pc Scraper Set
9" scraper, 11 blades, & 10 non-marring blades.
Sale \$19.38
Tool Club \$15.50



TITAN
TIT17002
2pc Scraper
4" & 9" long.
15 spare blades.
Sale \$19.94
Tool Club \$15.95



LIS52400
Fold-Up Scraper
7-3/4" Long.
Sale \$14.38
Tool Club \$11.50



TITAN
TIT11030
Sticker Scraper
Sale \$10.31
Tool Club \$8.25

SURE GRIP



SKT86006
9pc Sure Grip
Combination
Screwdriver Set
 5 Flat & 5 Phillips
 screwdrivers.
 Sale \$143.69

Tool Club \$114.95

SKT86320
6pc Sure Grip Set
 Sizes: P0x3", P1x4",
 P2x4", 1/8"x3",
 3/16"x4" & 1/4"x1/4"
 Sale \$67.44

Tool Club \$53.95

SKT86326
6pc Sure Grip Set
 Sizes: P1x4", P2x4",
 P3x6", 3/16"x4",
 1/4"x4" & 5/16"x6".
 Sale \$87.44

Tool Club \$69.95

SKT85112
2 in 1 Pocket Screwdriver
 Phillips & flat bit design.
 Sale \$6.88

Tool Club \$5.50



KDT80050H
6pc Phillips/Slotted
Dual Material Screwdriver Set

Ergonomic tri-lobe dual material handle provides the optimal balance of strength and efficiency. Dual material handle offers a more comfortable grip and higher performance. Non-Slip black oxide tip for more secure fit in fastener. Oil and solvent resistant handle provides a longer tool life.
 Sale \$76.25

Tool Club \$61.00



KDT80069H
4pc Phillips/Slotted
Dual Material Screwdriver Set

Ergonomic tri-lobe dual material handle provides the optimal balance of strength and efficiency. Dual material handle offers a more comfortable grip and higher performance. Non-Slip black oxide tip for more secure fit in fastener. Oil and solvent resistant handle provides a longer tool life.
 Sale \$81.19

Tool Club \$64.95

CUSHION GRIP



SKT86007
9pc Cushion Grip
Screwdriver Set
 5 Flat & 5 Phillips
 screwdrivers.
 Sale \$143.69

Tool Club \$114.95

SKT86330
6pc Cushion Grip
 Sizes: P0x3", P1x4",
 P2x4", 1/8"x3",
 3/16"x4", & 1/4"x4".
 Sale \$73.13

Tool Club \$58.50

SKT86336
6pc Cushion Grip Set
 Sizes: P1x4", P2x4",
 P3x6", 3/16"x4",
 1/4"x4" & 5/16"x6".
 Sale \$87.44

Tool Club \$69.95



KDT80066H
20pc Phillips/Slotted/Torx
Dual Material Screwdriver Set

Ergonomic tri-lobe dual material handle provides the optimal balance of strength and efficiency. Dual material handle offers a more comfortable grip and higher performance. Non-Slip black oxide tip for more secure fit in fastener. Oil and solvent resistant handle provides a longer tool life.
 Sale \$131.19

Tool Club \$104.95



KDT80051H
12pc Phillips/Slotted Dual
Material Screwdriver Set

Ergonomic tri-lobe dual material handle provides the optimal balance of strength and efficiency. Dual material handle offers a more comfortable grip and higher performance. Non-Slip black oxide tip for more secure fit in fastener. Oil and solvent resistant handle provides a longer tool life.
 Sale \$112.44

Tool Club \$89.95



VES22005EVA
5pc Ball Grip Screwdriver Set

VESSEL

Installed with a ratchet with 36 teeth gear to realize comfortable operation with fine turning. Cr-V Alloy Steel Shank specially hardened. Made in Japan.

Sale \$112.44 **Tool Club \$89.95**



VES3308EVA
8pc Wood-Compo Non-Slip
Tang-Thru Screwdriver Set

VESSEL

Extraordinary Non-Slip grip. Secure working efficiency. 70% wood composite resin, reproducing the natural material texture. Cr-V alloy steel shank specially hardened. Made in Japan.

Sale \$106.19 **Tool Club \$84.95**

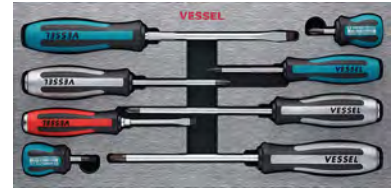

VES980MIXEVA
8pc MEGADORA Jawsfit Screwdriver Set - Mix

VESSEL

NEW Phillips JAWSFIT tip that firmly grips screws to reduce Cam-Out. Useful knurled blade for quick and slipless turning. Cr-V Alloy Steel Shank specially hardened. Made in Japan.
 Sale \$108.69

Tool Club \$86.95

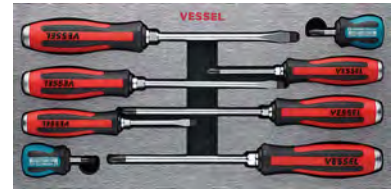

VES9308EVA
8pc MEGADORA Jawsfit Screwdriver Set - Red

VESSEL

NEW Phillips JAWSFIT tip that firmly grips screws to reduce Cam-Out. Useful knurled blade for quick and slipless turning. Cr-V Alloy Steel Shank specially hardened. Made in Japan.
 Sale \$118.69

Tool Club \$94.95



VES9008EVA
8pc MEGADORA Jawsfit Screwdriver Set - Blue

VESSEL

NEW Phillips JAWSFIT tip that firmly grips screws to reduce Cam-Out. Useful knurled blade for quick and slipless turning. Cr-V alloy steel shank specially hardened. Made in Japan.
 Sale \$93.69

Tool Club \$74.95

SCREWDRIVERS

NEW!



VESSEL®



VES220USB1U
Ball Grip Cordless Rechargeable Screwdriver
Forward/Reverse Switch. LED Illuminates work area.
17.71 lb/in torque (electric) 88.51 lb/in (manual).
3.6V Lithium-Ion battery.
Sale \$71.19 **Tool Club \$56.95**

VES220USBS1U
Ball Grip Cordless Rechargeable
High Speed Screwdriver
Forward/Reverse switch. LED Illuminates work area.
1200 RPM (MAX/no-load). 3.5 lb/in torque (electric)
88.5 lb/in (manual). 3.6V Lithium-Ion battery
Sale \$79.94 **Tool Club \$63.95**



VES220USB25U
Ball Grip Cordless Screwdriver
25pc bits. LED Illuminates work area. 17.71
lb/in torque (electric) 88.51 lb/in (manual).
3.6V Lithium-Ion battery.
Sale \$99.94 **Tool Club \$79.95**

BIT SETS



WERA05056490001
39pc Bits and Sockets Set
Combination tool set consisting of a ratchet, bits,
sockets and holder in a minimum of space. Ideal
as a universal companion for a whole host of
screw-driving applications
Sale \$124.94 **Tool Club \$99.95**

SVT63008
102PC Screwdriver
And Security Bit Set
Includes specialty bits
such as Allen, Torx,
Phillips, Slotted, Security
Bits, & Bit Adapter.
Sale \$36.19 **Tool Club \$28.95**



WILW8659
32pc Security Bit Set
3" bits fit most power drills,
screw guns & magnetic drivers.
Includes tri-wing bits, torque bits,
spanner bits & hex bits.
Sale \$16.88 **Tool Club \$13.50**



WILW9041
117pc Compact
Micro Bit Repair &
Maintenance Set
2 sided flip case with
crystal clear lids.
Sale \$26.19 **Tool Club \$20.95**



SUN9726
38 pc Mini Ratchet
& Bit Set
Includes 36 different
screwdriver bits, a quick
release extension, & micro
3-1/2" long ratchet. Will fit in the tightest of spaces.
Sale \$45.63 **Tool Club \$36.50**



EZRMS14
1/4" Mini
Master Set
1/4" flex head
drive with bit
holder end. 10 bits,
3" extension, 8 spline
metric sockets (4mm - 11mm).
Sale \$33.69 **Tool Club \$26.95**



VESSEL®



VES2200MBH120K01
Ball Grip Ratchet Screwdriver
10pc Screwdriver bit set.
Sale \$37.44 **Tool Club \$29.95**

IMPACT DRIVERS

LIS29200
3/8" Hand Impact
Tool Set
Can be used
with 3/8" drive
impact sockets.
Sale \$52.44
Tool Club \$41.95



LIS30200
1/2" Hand
Impact Tool Set
Can be used with 1/2"
drive impact sockets.
Sale \$52.44
Tool Club \$41.95



VIMIMP600K
Reversible 3/8" Dr.
Impact Driver & 6
Impact Bit Sets
Includes 8pc Impact
Hex, 8pc Torx Impact,
8pc 5/16" Shank Impact Hex, 8pc 5/16" Shank
Hex Metric, 8pc Triple Square & 8pc Torx Plus.
Sale \$124.94 **Tool Club \$99.95**



SVT63014
Impact Torsion Bit Set
50 PC IMPACT
TORSION BIT SET
Sale \$48.69
Tool Club \$38.95



KDT83518
33pc Ratcheting
T-Handle Hex Key Set
Keys made with alloy
steel. Chamfered
edges on both ends.
Ratcheting handle.
Dual Material Grip.
Sale \$49.94 **Tool Club \$39.95**



TITAN

TIT16251
50pc Torsion
Impact Bit Set
Impact grade.
Includes Phillips,
square drive,
hex, torx,
ball hex,
slotted,
adapters,
extensions,
chucks, & socket drivers.
Sale \$74.38 **Tool Club \$59.50**



TITAN

TIT16148
148pc Master
Screwdriver
Bit Set
Wide range
of screwdriver bits
including many hard to find security bits.
Sale \$62.44 **Tool Club \$49.95**



SUNEX®
TOOLS

SUN9729
208pc Master Bit Set
Includes standard & deep bits. Screwdriver
bits, nut drivers, security bits, torx,
tamperproof torx, hex, triple square,
bit holder, and many more!
S2 steel construction extends bit life.
Sale \$86.56 **Tool Club \$69.25**



TITAN

TIT16093
33pc Multi-Bit Precision Screwdriver Set
Extendable Screwdriver 8" Flexible Extension
Shaft Magnifying Glass PH000, PH00, PH0,
PH1 SL1.0, SL1.5, SL2.0, SL2.5, SL3.0, SL3.5,
SL4.0 PZ0, PZ1 T4, T5, T6, T7, T8, T9, T10,
T15, T20 0.7, 0.9, 1.3, 1.5, 2.0, 2.5, 3.0, 4.0
Sale \$18.69 **Tool Club \$14.95**



MAGNETS

EZRMAGMAT-R
Flexible
Magnetic
Organizational Mat
Ultra-Flexible.

This mat will fold, bend,
or roll any way you need it to.
Dimensions: 8.75in long x 5.5in wide x .19in thick
Sale \$37.44 **Tool Club \$29.95**

EZRED

NEW!



WILW1294
Fender Buddy
Flexible Tray

Soft silicone material grips
and molds to anything it sets on
and will not damage the surface. 1"x14.
Sale \$37.44 **Tool Club \$29.95**



TIT21264
5-7/8" Magnetic Tray
Sale \$8.13

Tool Club \$6.50



WILW1264
6" Magnetic Tray
Sale \$7.94

Tool Club \$6.35



TIT21265
Magnetic Tray
5-3/8" x 9-3/8".

Even works
upside down.
Sale \$13.13
Tool Club \$10.50



WILW1265
10" Magnetic Tray
Sale \$15.00

Tool Club \$12.00



TIT21262
Square
Magnetic
Parts Tray

10.5" x 11-1/2".
1" deep.
Rubber covered magnetic base.
Sale \$23.44

Tool Club \$18.75



TITAN

TIT11180
10.5" Magnetic Strainer
11" diameter. 4" deep.
Great for washing dirty tools.
Sale \$16.56

Tool Club \$13.25



EZRTRAY-CLR
3pc Collapsible
Magnetic Parts Trays

Expanded 2" deep,
4.25" Wide
Sale \$26.88

Tool Club \$21.50



EZRED

EZRTRAY-QGR
Expandable Magnetic
Quad Tray - Green

Sale \$36.19

Tool Club \$28.95



WILW83191
Flexible Magnetic Pickup Tool
Aluminum handle measures 24",
1.5 lb capacity magnetic head is 5/16
Sale \$7.44 **Tool Club \$5.95**



WILW83192
Flexible Magnetic Pickup
Super flexible with a narrow 4mm head
and a 300mm long shaft.
Sale \$11.19 **Tool Club \$8.95**



WILW1927
Swivel LED Magnetic Pick-Up Tool
Extends to 28.5". Lifts up to 8 lbs. LED light.
Sale \$11.88 **Tool Club \$9.50**



LIS31000
Telescoping Magnet
Extends from 14" to 23". Lifts 2-1/2 lbs.
Sale \$19.06 **Tool Club \$15.25**



WILW9101
Magnetic Pickup
Extends to 24". Lifts up to 8 pounds.
Removable rubber cap.
Sale \$5.63 **Tool Club \$4.50**



Performance Tool

WILW9102
Lighted Magnet
Bright LED light on the tip.
Extends from 7-1/2" to 32". Soft Handle.
Sale \$9.94 **Tool Club \$7.95**



MAY17960
Magnetic Pick-Up
2-1/2 LB, Telescoping stainless steel
handle extends from 6-1/4" to 34-1/4".
Sale \$13.69 **Tool Club \$10.95**



NEW!

MAY17966
Magnetic Pick-Up
16lb extends from 6-1/4" to 34-1/4".
Sale \$29.38 **Tool Club \$23.50**



NEW!

TIT11716
16lb. Magnetic Pick-up Tool
Telescopes from 7-3/4" to 30-3/4".
Sale \$8.44 **Tool Club \$6.75**



TITAN

TIT11065
3pc Utility Tool Set
Includes a mini magnetic tray,
telescoping inspection
mirror and magnetic
pickup tool.
Sale \$14.06 **Tool Club \$11.25**



MIRRORS



MAY17955
Lighted Inspection Mirror
3 lb magnet – 5 lumens per LED
extends from 9" to 30".
Sale \$20.94 **Tool Club \$16.75**



LIS32050
2-1/4" Telescoping Mirror
Extends from 10" to 14".
Sale \$13.13 **Tool Club \$10.50**



MAY17954
Inspection Mirror
3-1/4" Telescoping stainless steel
handle extends from 10-1/4" to 29".
Sale \$16.19 **Tool Club \$12.95**



MAY17957
Rectangular Inspection Mirror
2 X 3-1/2" rectangular scratch-resistant
glass mirror.
Sale \$11.19 **Tool Club \$8.95**



WILW1263
Led Inspection Mirror
Rectangular mirror with Light Extends to over 34"
Sale \$12.44 **Tool Club \$9.95**

RETRIEVERS

TIT11064
3 in 1 Flexible Retriever
Retriever claw, LED light,
and 3lb magnet.
Sale \$19.19
Tool Club \$15.35



WILW83198
28" Long Flex
Magnetic Claw Retriever
Sale \$13.13 **Tool Club \$10.50**



LIS31140
23" Long Flexible
Retrieving Tool
Sale \$13.13 **Tool Club \$10.50**



SUN9813
3pc Pick Up Tool Set
Extra Long 24" length shafts with total
flexibility. 1/4inch bit socket driver.
Sale \$62.44 **Tool Club \$49.95**

IRWIN.



IWN2078710
3pc GrooveLock Pliers Set
 Push button for easy size adjustment.
 2x number of jaw positions. Sizes: 8", 10" & 12"
 Sale \$90.94 **Tool Club \$72.75**

GEARWRENCH



KDT82594C
4pc Pitbull Auto-Bite Tongue & Grove Dual Material Pliers w/ K9 Jaws
 Exclusive Auto-Bite lever enables one handed jaw adjustment. Aggressive angled teeth for increased grip. Grip Zone handles for non-marring grip.
 Sale \$107.44 **Tool Club \$85.95**

NEW!



SUN3622V
3PC Water Pump Pliers
 7", 10", 12" Self-locking push button design for faster size adjustment. Self-locking push button design for faster size adjustment.
 Sale \$87.44
Tool Club \$69.95



COMPOUND JOINT PLIERS



KDT82106
2pc Double-X Pliers Set
 Includes straight and 45° pliers. Jaws open greater distance than the handle for added reach in tight locations. Flush rivet.
 Sale \$74.94 **Tool Club \$59.95**



KDT82107
3pc Double-X™ Hose Grip Plier Set
 3 sizes of hose grip pliers, all double joint.
 Sale \$112.44 **Tool Club \$89.95**

EXTRA LONG PLIERS

SUN3600V
4pc 11" Long Nose Plier Set
 Includes: Straight, 20°, 45° & 90° pliers. All are 11" long.
 Sale \$66.88
Tool Club \$53.50



SUN3706V
4pc 16" Needle Nose Pliers Set
 Includes: 45° & 90° Angle, Straight, & Curved Pliers.
 Sale \$93.69
Tool Club \$74.95



WILW1044
11" Long Nose Plier
 Sale \$12.44
Tool Club \$9.95



WILW1045
11" Long Nose 30° Curved Plier
 Sale \$12.44
Tool Club \$9.95



WILW1046
11" Long Nose Right Angle Plier
 Sale \$12.44
Tool Club \$9.95



WILW1047
11" Long Nose Offset Plier
 Sale \$12.44
Tool Club \$9.95



WILW1048
11" Hose Clamp Plier
 Sale \$12.44
Tool Club \$9.95



SUN3703V
3pc X-Long Hose Gripper Pliers
 11" Long. Sizes: 5/16", 1/2" & 3/4".
 Sale \$59.38 **Tool Club \$47.50**



ALUMINUM PIPE WRENCHES

Constructed of strong and lightweight aluminum for strength and ease of use.



Part #	Length	Sale	Club
WILW2114	14"	\$28.69	\$22.95
WILW2124	24"	\$58.69	\$46.95
WILW2148	48"	\$199.94	\$159.95

ADJUSTABLE WRENCHES

SUN9618A
4pc Adjustable Wrench Set
 Sizes: 6", 8", 10" & 12".
 Ergonomic no-slip rubber grip.
 Sale \$68.13
Tool Club \$54.50



CL8WCB8
8" Large Capacity Adjustable Wrench
 Over 1-1/2" opening.
 Sale \$39.38
Tool Club \$31.50



CL6SWCB
6" Xtra Slim Adjustable Wrench
 Xtra slim 3/16" jaws. Super wide jaw capacity (1.34").
 Sale \$43.13
Tool Club \$34.50



IWN2078706
Vise-Grip 4pc Adjustable Wrench Set
 Sizes: 6", 8", 10" & 12".
 Double chrome vanadium construction
 Sale \$80.31
Tool Club \$64.25



TITAN SHEARS



Cuts up to 1/4" thick. Locking mechanism.

Part #	Size	Sale	Club
TIT12441	7"	\$15.63	\$12.50
TIT12442	9"	\$18.13	\$14.50
TIT12443	10"	\$21.19	\$16.95
TIT12444	10" Offset	\$22.44	\$17.95

ADJUSTABLE WRENCHES

CHAN NEL LOCK

RUGGED CHROME VANADIUM STEEL CONSTRUCTION WITH CHROME FINISH



Part #	Length	Jaw Capacity	Sale	Club
CL808	8"	0.75"	\$29.06	\$23. ²⁵
CL810	10"	0.94"	\$32.44	\$25. ⁹⁵
CL812	12"	1.13"	\$48.44	\$38. ⁷⁵
CL815	15"	1.31"	\$78.69	\$62. ⁹⁵
CL818	18"	1.63"	\$137.44	\$109. ⁹⁵
CL824	24"	2.25"	\$262.44	\$209. ⁹⁵

LOCK RING PLIERS

For snap rings without holes, found on brakes, transmissions, & clutches.



LANG1705
10" Parallel Jaw Lock Ring Plier
Sale \$58.13 **Tool Club \$46.50**



LANG1407
9" Straight Tip Lock Ring Plier
Sale \$37.44 **Tool Club \$29.⁹⁵**



LIS44900
9" Lock Ring Plier
Sale \$21.19 **Tool Club \$16.⁹⁵**



LANG1406
3pc Lock Ring Pliers Set
9" Straight Tip, 9" Bent Tip and 9" Right Angle Tip.

Spreads, installs & removes lock rings that don't have holes. Made in the USA.
Sale \$94.38 **Tool Club \$75.⁵⁰**



WILW5212
300pc External Snap Ring
Contains 18 various popular sizes.
Sale \$10.63
Tool Club \$8.⁵⁰



LANG1421
Quick Switch Pliers with Adjustable Stop and Tip Kit
Internal Sizes: 1/4" - 1" (8 - 26mm)
External Sizes: 1/8" - 1" (3 - 26mm).
Sale \$30.31 **Tool Club \$24.²⁵**



LANG1434
Quick Switch Pliers with Tip Kit
Internal Sizes: 3/8" - 2" (10 - 48mm)
External: 1/4" - 2" (7 - 48mm)
Sale \$34.94 **Tool Club \$27.⁹⁵**

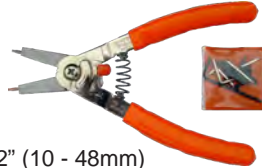

LANG1465
3pc Quick Switch Pliers Set
Includes LANG1421, LANG1434, and LANG75 - Internal/External Ring Pliers w/ Automatic Ratchet Lock.
Includes 5 pairs of interchangeable tips.
Sale \$134.94 **Tool Club \$107.⁹⁵**



LANG87
H.D. Pliers with Tip Kit
Internal & External 3.5" - 7".
Compound screw lever for easy installation and removal of extra large retaining rings.
Sale \$119.38 **Tool Club \$95.⁵⁰**

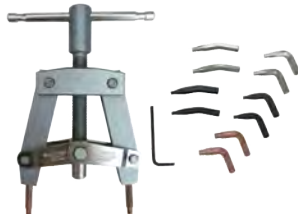

CTA4031M
Master Lock Ring Tool Kit
Hold single handle then adjust screw mechanism to control forged jaws to remove and install lock rings securely and quickly
Sale \$187.44 **Tool Club \$149.⁹⁵**

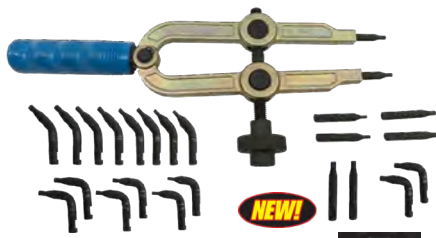

AST9401
10pc Snap Ring Pliers Set
Operates both internal & external rings. Comfortable insulated vinyl handles.
Sale \$46.88
Tool Club \$37.⁵⁰



LANG3495
12pc Combination Internal & External Snap Ring Pliers
Sizes: .038, .047, .070, & .090 in 0, 45 and 90-degree angles.
Sale \$140.31 **Tool Club \$112.²⁵**



LANG3595
12pc Quick Switch Snap Ring Plier Set
Quick switch design allows the user to change from internal to external configurations without taking the pliers apart. Cushion grip handles for extra support. Sizes: .038", .047", .090" in 0°, 45°, & 90° angles.
Sale \$196.19 **Tool Club \$156.⁹⁵**

XL SNAP RING PLIERS



LANG1485
Internal Retaining Ring Pliers
Ring Sizes: 3-1/16" - 6-1/4"
Sale \$88.44 **Tool Club \$70.⁷⁵**

LANG1486
External Retaining Ring Pliers
Ring Sizes: 3-1/2" - 6-1/2"
Sale \$88.44 **Tool Club \$70.⁷⁵**



AST9402
XL 16" Snap Ring Set
One internal plier, one external plier. With straight, 45° and 90° tips.
Sale \$60.63 **Tool Club \$48.⁵⁰**

INSULATED TOOLS

**TIT17237
7pc Insulated
Electrical
Screwdriver Set**

Sizes included:
(3) Phillips (3" x #0, 4" x #1 and 4" x #2) and
(4) Slotted (3" x 1/8", 4" x 5/32", 5" x 7/32" &
6" x 1/4"). Insulated blades for applications
up to 1000 volt AC & 1500 volt DC.
Magnetic drive tips.
Sale \$28.13 **Tool Club \$22.50**



wiha
**WIHA32867
10pc
Insulated
Tool Set**

Includes: 4 pliers, crimpers, 5 screwdrivers.
Sale \$318.13 **Tool Club \$254.50**



wiha
**WIHA21093
Insulated 16PC Deep Offset
Metric Wrench Set**

Sizes: 8mm - 32mm. Certified to 1000V AC
or 1500V DC. Protective double insulation
molded directly onto the wrench. Forged
chrome cadmium steel under insulation.
Comes with roll-up pouch.
Sale \$874.94 **Tool Club \$699.95**



wiha
**WIHA21094
Insulated 16PC Deep
Offset SAE Wrench Set**

Sizes: 8mm - 32mm. Certified to 1000V AC
or 1500V DC. Protective double insulation
molded directly onto the wrench. Forged
chrome cadmium steel under insulation.
Comes with roll-up pouch.
Sale \$791.19 **Tool Club \$632.95**



wiha



**WIHA32800
Insulated 80PC Set In Rolling Tool Case**
Insulated 10,000V tested and 1,000V rated.
Set includes: Pliers, Adjustable Wrench,
Slotted Screwdrivers, Phillips Screwdrivers,
SAE Nut Drivers, Metric Nut Drivers,
Hex SAE T-Handles, Hex Metric T-Handles,
Torx Screwdrivers, Square Screwdrivers
Sale \$2,499.94 **Tool Club \$1,999.95**

CHAN NEL LOCK



**CLC8R-8
8pc Code Blue Plier Set**
Includes 2 tongue & groove, linemen's,
end cutter, long nose, cutting, crimping
& cable cutter. Code Blue special grip.
Sale \$287.44 **Tool Club \$229.95**



CHAN NEL LOCK



**CL431KB
5pc Plier Set**
Includes: 2 Tongue & Groove,
Cutting, Long Nose, & Slip Joint.
Sale \$99.94 **Tool Club \$79.95**



**EZRKWP2
2pc Kiwi
Plier Set**

Includes 6" short &
8" long needle-nose
pliers at an angle.
Curved handles.
Sale \$28.13
Tool Club \$22.50



**IWN2078707
4pc VISE-GRIP
Pliers Set**
6" Diagonal Cutting,
6" Slip Joint,
8" Long Nose &
10" Groove Joint.
Sale \$71.88
Tool Club \$57.50



**SUNEX
TOOLS**



**SUN3704V
3pc HD Pilers Set**
11" Heavy Duty High Leverage Cutting Pliers,
1/2" Adjustable Hose Gripper Plier,
3/4" Adjustable Hose Gripper Plier.
Sale \$81.88 **Tool Club \$65.50**

MADE IN USA **TONGUE GROOVE
WATER PUMP** **CHAN NEL LOCK**

Part #	Length	Sale	Club
CL424G	4-1/2"	\$20.94	\$16.75
CL426G	6-1/2"	\$17.44	\$13.95
CL410G	9-1/2"	\$24.06	\$19.25
CL420G	9-1/2"	\$20.94	\$16.75
CL430G	10"	\$21.88	\$17.50
CL440G	12"	\$25.31	\$20.25
CL460G	16"	\$41.19	\$32.95
CL480G	20"	\$78.69	\$62.95



MADE IN USA **SLIP JOINT
W/ WIRE SHEAR**

Part #	Length	Sale	Club
CL526G	6" THIN	\$14.38	\$11.50



MADE IN USA **HIGH LEVERAGE
CUTTING**

Part #	Length	Sale	Club
CL337G	7"	\$26.19	\$20.95
CL338G	8"	\$28.69	\$22.95
CL447G	7" angled head	\$35.63	\$28.50



MADE IN USA **LINESMAN
ROUND NOSE**

Part #	Length	Sale	Club
CL369G	9"	\$38.69	\$30.95



MADE IN USA **LONG NOSE
WITH CUTTER**

Part #	Length	Sale	Club
CL326G	6"	\$31.19	\$24.95
CL317G	7"	\$29.38	\$23.50
CLE318	8"	\$29.94	\$23.95



**CL442G
12" V-Jaw**
Opens to 2-1/4"
Sale \$24.06 **Tool Club \$19.25**



**CL358G
8" End Cutter**
Sale \$34.38 **Tool Club \$27.50**



KDT82203
3pc Pitbull Dipped Handle Electrician's Plier Set
 Professional, ergonomic grips wipe clean easily. Includes: Lineman's Pliers, Diagonal Cutting Pliers, Long Nose Pliers & Universal Pliers.
 Sale \$101.88 **Tool Club \$81.50**



KDT82204
6pc Pitbull Dipped Handle Mixed Plier Set
 Professional, ergonomic grips wipe clean easily. Includes: Lineman's Pliers, Diagonal Cutting Pliers, Long Nose Pliers, Slip Joint Pliers, & (2) Tongue and Groove Pliers.
 Sale \$149.94 **Tool Club \$119.95**



KDT82204C
6pc Pitbull Dual Material Mixed Plier Set
 Professional, ergonomic dual material grips with tether point. Includes: Lineman's Pliers, Diagonal Cutting Pliers, Long Nose Pliers, Slip Joint Pliers, (2) Tongue and Groove Pliers.
 Sale \$156.19 **Tool Club \$124.95**



Milwaukee **NEW!**
MLW48-22-3695
5pc TORQUE LOCK™ Locking Pliers Kit
 Faster Setup and additional locking force. Hardened jaws with better grip force. Screwdriver through-hole provides you with leverage for tightening the thumb screw. Set Includes: 5" Curved Jaw, 7" Curved Jaw, 10" MAXBITE™ curved locking pliers, 7" straight jaw locking pliers & 6" long nose locking pliers.
 Sale \$78.69 **Tool Club \$62.95**



MLW48-22-3690 **NEW!**
10pc Torque Lock™ Locking Pliers Kit
 Set Includes: 5" Curved Jaw, 7" Curved Jaw, 7" MAXBITE™, 10" with MAXBITE™, 7" Straight Jaw, 10" Straight Jaw, 6" Long Nose, 9" Long Nose, 6" C-Clamp & 11" C-Clamp
 Sale \$168.69 **Tool Club \$134.95**

SWIVEL PAD "C" CLAMPS
 These C-Clamps have swivel pads. Good for holding sheet metal.
IRWIN.

Part #	Size	Sale	Club
IWN4SP	4"	\$19.38	\$15.50
IWN6SP	6"	\$24.06	\$19.25
IWN11SP	11"	\$35.94	\$28.75
IWN18SP	18"	\$50.94	\$40.75

"C" CLAMPS
IRWIN.

Part #	Size	Sale	Club
IWN6R	6"	\$21.56	\$17.25
IWN11R	11"	\$35.94	\$28.75
IWN18R	18"	\$50.94	\$40.75
IWN24R	24"	\$56.88	\$45.50

IWN18DR
18" Wide Jaw Locking Pliers
 7.5" Jaw Capacity
 Sale \$57.81 **Tool Club \$46.25** **IRWIN.**



IWN9AC
9" Locking Panel Clamp
 Bottom jaw slides forward to clamp at 90°. Sale \$32.44 **Tool Club \$25.95**



IWN9R
9" Locking Welding Clamp
 Sale \$33.44 **Tool Club \$26.75** **IRWIN.**



IWN12LC
12" Large Jaw Locking Pliers
 Heavy-duty jaws grip around work of all shapes. Sale \$33.13 **Tool Club \$26.50**



IWN1078 **IRWIN.**
10pc VISE-GRIP Locking Pliers Set with Tray
 Includes 6" and 11" Original Locking Clamps, 10" and 7" straight jaw, 10" and 7" curved jaw, 7" and 5" curved jaw with wire cutter, 6" and 9" long nose with wire cutter.
 Sale \$187.44 **Tool Club \$149.95**

SPECIALTY CLAMPS
 Straight jaw gives maximum contact on flat, square, or hex surfaces.
IRWIN.

Part #	Length	Sale	Club
IWN7R	7"	\$23.44	\$18.75
IWN10R	10"	\$25.31	\$20.25

Curved jaw will grab any shape object and hold it tight.
IRWIN.

Part #	Length	Sale	Club
IWN7CR	7"	\$22.94	\$18.35
IWN10CR	10"	\$25.31	\$20.25

Combines curved jaw plier with a wire cutter.
IRWIN.

Part #	Length	Sale	Club
IWN4WR	4"	\$17.44	\$13.95
IWN5WR	5"	\$22.81	\$18.25
IWN7WR	7"	\$23.44	\$18.75
IWN10WR	10"	\$25.31	\$20.25

Long nose with wire cutter.
IRWIN.

Part #	Length	Sale	Club
IWN4LN	4"	\$20.94	\$16.75
IWN6LN	6"	\$25.31	\$20.25
IWN9LN	9"	\$30.31	\$24.25

IWN20R
Locking Chain Clamp
 18" Chain
 Sale \$40.63 **Tool Club \$32.50** **IRWIN.**



IWNRR
Locking Pinch-Off Tool
 Sale \$24.06 **Tool Club \$19.25** **IRWIN.**



IWN8R
8" Locking Sheet Metal Tool
 Makes bending, forming & crimping jobs easier & faster. Sale \$28.13 **Tool Club \$22.50**



SPARK PLUG SOCKETS



SKT4499

12pc 3/8" Drive Spark Plug Socket Set

Includes: Flex 13/16", 5/8", 9/16", 14mm - 6 pt. Standard - 9/16", 5/8", 3/4", 13/16" 14mm - 6 Pt 14mm 12 PT, Flex -14mm 12 Point Extra Long 5/8" 6 Pt.

Sale \$262.44 **Tool Club \$209.95**

SUN8845

7pc 3/8" Drive Spark Plug Socket Set

Sizes: 9/16", 5/8", 13/16", 16mm Thin Wall & 9/16", 5/8" & 13/16" Extra Deep.

Sale \$89.38 **Tool Club \$71.50**



SUNEX TOOLS



KDT41740D

3pc Magnetic Universal 5/8" Spark Plug Set

4", 6" & 11" long. All have magnets.

Sale \$76.88 **Tool Club \$61.50**

NEW!



CTA5061

5 Pc. Spark Plug Socket Set

10" sockets
 #1730 - 5/8" x 12 Pt (OAL: 6")
 #2380 - 5/8" x 6 Pt (OAL: 10")
 #2390 - 9/16" x 6 Pt (OAL: 10")
 #2394 - 14mm x 6 Pt (OAL: 10")
 #2376 - 14mm x 12 Pt (OAL: 2.5")

Sale \$112.44 **Tool Club \$89.95**



NEW!



CTA2030

4 Pc. Spark Plug Swivel

14mm & 16mm 12 point swivel spark plug sockets to access hard to reach spark plugs. 3.5" Short 8.5" Long.

Sale \$95.63 **Tool Club \$76.50**



NEW!



CTA7392

6 Pc. Spark Plug & Glow Plug Socket Set

8mm, 9mm, 10mm, 12mm(6pt) 14mm (12pt) 16mm(12pt).

Sale \$137.44 **Tool Club \$109.95**



SPARK PLUGS



Part #	Size	Length	Sale	Club
CTA1180	14mm	12pt	\$15.94	\$12.75
CTA2395	5/8"	14"	\$43.13	\$34.50
CTA7654	14mm	8.7"	\$39.69	\$31.75
CTA1061	14mm	3.6"	\$28.44	\$22.75
SUN884504	16mm	1.54"	\$12.44	\$9.95
SUN884505	9/16"	6.8"	\$24.94	\$19.95
SUN884506	5/8"	7.4"	\$26.88	\$21.50



VIMSPM100

Spark Plug Socket Master Set

Standard: 14mm, 9/16", 5/8" & 13/16"

Extra Deep: 9/16" - 13/16"

U-Joint: 14mm, 9/16" - 13/16"

Thin Wall: 14mm & 16mm

Sale \$137.44 **Tool Club \$109.95**

FORD SPARK PLUG

LIS65700

3V Ford Broken Plug Remover

Unique porcelain remover tool, porcelain pusher and a self-tapping puller.

Sale \$124.94 **Tool Club \$99.95**

LIS65600

Broken Spark Plug Remover

For 2004+ Ford Triton with 3 valves per cylinder.

Sale \$99.94 **Tool Club \$79.95**

CAL39300

Three Valve Ford Triton Insert Kit

Designed to aid in the repair of, 3-valve 5.4 L and 6.8 L engines built before 10/9/07 and 3-valve 4.6 L engines built before 11/30/07 for many 2004-2008 Ford, Lincoln & Mercury.

Sale \$287.44 **Tool Club \$229.95**

CAL38900

Triton Spark Plug Thread Repair Kit

Works with Ford Triton Motors (96' to 03'). Aids in repairing Ford Modular Cylinders Heads.

Sale \$387.44 **Tool Club \$309.95**

SPARK PLUG TOOLS

LIS19380

Inductive Spark Indicator

Sale \$12.44 **Tool Club \$9.95**



TOOL AID

PROFESSIONAL AUTOMOTIVE TOOLS

TA36350

In-Line Spark Checker

For recessed plugs, noid lights and IAC test lights kit. Test spark plug circuits, electronic fuel injection signals & idle air control circuits.

Sale \$85.63 **Tool Club \$68.50**



TA23970

4pc In-line Spark Tester

Set for recessed plugs.

Sale \$26.88

Tool Club \$21.50



LIS51750

Adjustable Spark Plug Boot Pliers

Jaws can adjust to 5 positions.

Sale \$38.44

Tool Club \$30.75



LIS52990

2 Position Spark Plug Boot Pliers

Special jaws can grip from front or side.

Sale \$13.44

Tool Club \$10.75



LIS20610

Dual In-line Spark Tester

Features reversible, straight / 90 deg. boot.

Sale \$20.63

Tool Club \$16.50



LIS20580

In-Line Spark Tester w/ Coil-On-Plug Wire

Features reversible, straight / 90 deg. boot & 7" extension plug wire.

Sale \$37.44 **Tool Club \$29.95**



SPARK PLUG THREAD REPAIR

TOOL AID

MADE IN USA



LIS65200

Spark Plug Hole Repair Kit

Replaces stripped spark plug threads on aluminum heads with 14mm spark plugs.

Sale \$151.56

Tool Club \$121.25



CTA2340

Spark Plug Cylinder Head Rethreader Kit - 14mm

Repairs damaged threads on aluminum heads. Includes 3/8", 7/16" & 3/4" inserts.

Sale \$29.94 **Tool Club \$23.95**



THREAD REPAIR

TIT51950
Eco Burr™
External Deburrer
 Quickly repairs damaged threads on steel bolts.
 Works with most power drills on materials ranging from 5/16" to 7/8".
 Sale \$58.13
Tool Club \$46.50



CTA3838
E-Z Chamfer®
 5 Point design for quick and clean deburring
 Size: 5/16 - 7/8" Range (8-22mm)
 Sale \$56.19 **Tool Club \$44.95**



CTA8240
53pc Universal Rethreading Set
 Includes thread files and color coded taps and dies for the following sizes:
 Metric: 6, 8, 10, 11, 12, 14mm
 SAE NC: 1/4", 5/16", 3/8", 7/16", 1/2", 9/16"
 SAE NF: 1/4", 5/16", 3/8", 7/16", 1/2", 9/16"
 Sale \$184.94 **Tool Club \$147.95**



LIS70500
Tap Sockets
 Holds taps up to 1/2".
 Sale \$44.38
Tool Club \$35.50



LIS71670
5pc Large Tap Socket Set
 Holds taps up to 1"
 Sale \$100.94
Tool Club \$80.75



IWN3095001
2pc Tap Sockets
 Adjustable sockets holds taps up to 1/2"
 Sale \$42.44
Tool Club \$33.95



WILW88031
H.D. Nut Splitter
 For splitting nuts 7/16" - 7/8".
 Use a 3/4" Wrench or socket for the adjustment bolt.
 Sale \$16.19 **Tool Club \$12.95**



LANG2573
3pc Thread Restorer Files
 For SAE & Metric.
 24 sizes.
 Sale \$39.38 **Tool Club \$31.50**



KDT3887
77pc Ratcheting SAE/Metric Tap & Die Set
 Includes 18 Taper Taps, 14 Plug Taps, 34 Hex Dies, Medium ratcheting T-wrench, 2 tap adapters, medium hex die adapter, sliding handle for tap adapter, 4mm hex key, 2 thread pitch gauges & hex die spacer.
 Sale \$228.69 **Tool Club \$182.95**



LANG2599
20pc Axle Rethreader
 Will repair threads on most axles.
 Includes:
 11/16"-24, 3/4"-16, 3/4"-20, 13/16"-20, 27/32"-20, 7/8"-14, 1"-14, M16x1, M16x1.5, M18x1.5, M19x1.5, M20x1, M20x1.25, M20x1.5, M22x1, M22x1.5, M24x1.5, M24x2, M25x1.5, M27x2
 Sale \$124.38 **Tool Club \$99.50**



TAP & DIE SETS

IWN26376
76pc Tap & Hex Die Set
Machine Screw/SAE/METRIC
 3mm to 12mm. #4 to 1/2" plus tools.
 Sale \$353.13 **Tool Club \$282.50**



IWN26394
53pc METRIC Tap & Hex Die Set
 Tap: 3mm to 12mm; Dies: 3mm to 18mm
 Sale \$419.81 **Tool Club \$335.85**



IWN97311
25pc Large Size METRIC Tap & Hex Die
 Tap: 14mm to 24mm; Dies: 14mm to 24mm
 Sale \$424.94 **Tool Club \$339.95**



IWN24606
41pc SAE Tap & Hex Die Set
 #4 to 1/2" plus tools.
 Sale \$211.88 **Tool Club \$169.50**



IWN26317
41pc METRIC Tap & Hex Die Set
 3mm to 12mm plus tools.
 Sale \$214.38 **Tool Club \$171.50**



IWN97094
25pc LARGE SIZE SAE Tap & Hex Die Set
 TAP: 9/16 to 1" Dies: 9/16" to 1".
 Sale \$387.44 **Tool Club \$309.95**



SCREW EXTRACTORS

IRWIN

IWN3101010
48pc Master Extractor Set
 Includes
 6 spiral extractors, 13 Stubby extractors,
 16 left-handed drill bits & 13 stud/bolt removers.
 Sale \$394.94 **Tool Club \$315.95**



IWN53227
25pc Stubby Extractor Set
 Sizes: 1/8" to 7/8"
 Sale \$104.94
Tool Club \$83.95



IWN53535
5pc Spiral Extractor
 Sizes: 3/32" to 5/8"
 Sale \$18.69
Tool Club \$14.95



IWN30520
5pc Left-Handed Drill Set
 Sale \$44.38
Tool Club \$35.50



BOLT & NUT EXTRACTORS

AST7402 
2pc 1/2" Dr. Double End Wheel Lock & Lug Nut Removal Socket Set
 Sizes: 3/4" (19mm) & 13/16" (21mm),
 7/8" (22mm) & 15/16" (24mm).
 Sale \$53.69 **Tool Club \$42.95**



AST7404
4pc Flank Bite Damaged Lug Nut Socket Set
 Protective sleeves free spin instead of scuffing wheels. Sizes: 17mm, 19mm (3/4"), 21mm (3/16"), & 22mm.
 Sale \$49.94 **Tool Club \$39.95**



CTA5700
6 Pc. Emergency "Twist" Flip Socket Set
 Removes damaged & corroded nuts 17MM, 19MM, 21MM, 7/8", 13/16".
 Sale \$137.44 **Tool Club \$109.95**

IWN394002
5pc Bolt & Nut Remover
 Reverse spiral flutes provide maximum gripping power. Sizes: 5/16" to 3/4"
 Sale \$45.94 **Tool Club \$36.75**



IWN3094001 
5pc DEEP Bolt/Nut Remover
 Extra deep sizes: 3/8", 7/16", 1/2", 9/16" & 5/8"
 Sale \$60.63 **Tool Club \$48.50**



KDT84787 
4pc Bolt Biter™ Screw Extractor Set
 Compatible with fastener sizes ≤ 1/4" – 5/8" & M5-M16. Bi-directional design loosens or tightens damaged fasteners.
 Sale \$31.19 **Tool Club \$24.95**



KDT84786 
10pc Bolt Biter™ Screw Extractor Set
 Compatible with fastener sizes ≤ 1/4" – 5/8" and M5-M16. 5 Sizes of left-hand drill bits included for extraction needs from start to finish. Bi-directional design loosens or tightens damaged fasteners. Comes with customizable & stackable storage case.
 Sale \$83.69 **Tool Club \$66.95**



IWN53226
10pc Spiral Flute Screw Extractor Set
 Screw Range 1/8 to 13/32"
 Sale \$42.44 **Tool Club \$33.95**

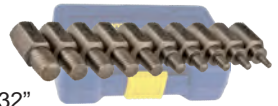

IWN11119 
10pc Spiral Flute Screw Extractors
 5 lefthand cobalt drill bits
 5 spiral extractors; Sizes: 1-5
 Sale \$64.38 **Tool Club \$51.50**



CHPX1-XL5LH
Left Hand Heavy Duty Drill/Screw Extractor Set
 Sizes: 5/64, 7/64, 5/32, 1/4, 19/64
 Screw extractors: #1-5
 Sale \$106.19
Tool Club \$84.95



TIT16013
10pc Extractor Set
 5 spiral extractors & 5 titanium coated left hand drill bits.
 Sale \$21.88
Tool Club \$17.50



MAY37331
4pc Extractor Set
 Square screw extractors for large screws.
 Sale \$54.94
Tool Club \$43.95



MAY37332
5pc Extractor Set
 Square screw extractors for smaller screws.
 Sale \$32.44 **Tool Club \$25.95**



IWN3073004 
17pc Hole Saw Kit
 Sizes: 5/8" to 3". Includes arbors.
 Sale \$151.56
Tool Club \$121.25



STUD EXTRACTORS

LIS19250
6pc Stud Remover & Installer
 Removes studs, nuts and bolts 1/4, 5/16, 3/18, 7/16, 1/2, 9/16, 6, 8, 10, 11, 13, & 14mm
 Sale \$55.94 **Tool Club \$44.75**



KDT41760D
8pc SAE/Metric Stud Removal Set
 Sizes: 6, 8, 10, 12mm
 1/4", 5/16", 3/8", 7/16"
 Sale \$93.44 **Tool Club \$74.75**



MAY29895  
3/8" Stud Extractor
 Fits 1/4" to 1/2" (6 - 12mm) studs. Impact gun compatible.
 Sale \$96.19 **Tool Club \$76.95**



TIT16023
3/8" Stud Extractor
 Fits 1/4" to 1/2" (6 - 12mm) studs. Impact gun compatible.
 Sale \$26.88 **Tool Club \$21.50**



CARBIDE BURR SETS

CHBK8P-RE
8pc Titanium Carbide Burr Kit
 Sizes: SD3, SD1, SC1, SC3, SA3, SA5, SF3 & SF5
 Sale \$249.94
Tool Club \$199.95



AST2181
8pc Carbide Burr
 Fits die grinders.
 Sale \$99.94
Tool Club \$79.95



AST2185 
5pc Long Double Cut Carbide Burr Set - 4.5"
 1/4" shank. 4.5" Long.
 Sale \$99.94 **Tool Club \$79.95**



CHPSA80-SET 
3pc Maintenance Reamers
 1/2" straight shank. Sizes: 1/2", 5/8", & 3/4".
 Sale \$249.94 **Tool Club \$199.95**



LUG NUT DRILLER

CTA1775
Lug Driller
 Remove the most difficult locking lug bolts quickly, safely & without damage to wheel or rim.
 Sale \$437.44
Tool Club \$349.95



UNIBITS



Part #	UNIBIT	Sale	Club
CHPMSD-1/2X1/8	#1	\$35.63	\$28.50
CHPMSD-1/2X3/16	#2	\$33.13	\$26.50
CHPMSD-3/4X1/4	#3	\$53.69	\$42.95
CHPMSD-7/8X3/16	#4	\$62.44	\$49.95
CHPMSD-1-3/8X1/4	#5	\$119.38	\$95.50



CHPMSD-SET
3pc Step Drill Set
Hd set comes with unibit #1,#2,#3
Sale \$124.94
Tool Club \$99.95



TIT16503
3pc Step Drill Set
Sale \$26.88
Tool Club \$21.50

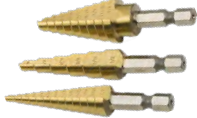

TITAN

TIT11170
170pc Titanium Coated Drill Bit Set
19 different drill bit sizes.
Lasts up to six times longer than a normal bit.
Sale \$119.38
Tool Club \$95.50



DRILL BIT SETS

CHPTWISTER-XL28
29pc Brute Platinum Drill Bit Set
Sizes: 1/16" - 1/2" x 64ths.
Mechanic's length bits with flattened shank. 135° split point drills accurately. Ultimate workhorse for drilling through tough alloys including stainless steel!
Sale \$174.94
Tool Club \$139.95



CHPTWISTER-XGO
29pc BlackGold® Drill Bit Set
Sizes: 1/16" - 1/2" x 64ths.
Recommended for drilling stainless steels, titanium alloys and hard steel.
Sale \$162.44
Tool Club \$129.95



IWN3018002B
29pc Cobalt Drill Bit Set
Sizes: 1/16" - 1/2". Constructed of M-42 8% cobalt high speed steel for super abrasive resistance in tough metals
Tap & Drill selection chart included. Removable cartridges.
Sale \$245.31
Tool Club \$196.25



SVT63106
29pc Stepped Cutter Drill Bit Set
Sizes: 1/16" - 1/2".
Outlasts split point bits 4-1. Never needs pilot hole. Mechanics length makes them less prone to breakage.
Sale \$312.44
Tool Club \$249.95



ASTTS21
21pc TurboStep 1/16" - 3/8" Drill Bits
Spiral fluted stepped tip drill bits.
Sale \$137.44
Tool Club \$109.95



ASTTS29
29pc TurboStep 1/16" - 1/2" Drill Bits
Spiral fluted stepped tip drill bits.
Sale \$237.44
Tool Club \$189.95



CHPXL12-8P
8pc Platinum S&D Drill Set
1/2" shank.
Sizes: 9/16" - 1" x 16ths.
High speed steel.
Sale \$374.94
Tool Club \$299.95



DRILLING

BOLT BITER™

- Bi-Directional Design for Removing or Tightening Damaged SAE & Metric Fasteners
- Tapered Entry Enables Socket to Easily Seat on a Damaged SAE & Metric Fastener
- Up to 10x Longer Impact Life vs. Competition

KDT84782
8pc 1/4" & 3/8" Drive Bolt Biter™ Impact Extraction Socket Set
Sizes: 7mm, 8mm [5/16"], 10mm, 11mm [7/16"], 12mm, 13mm, 14mm [9/16"], 16mm [5/8"]
Sale \$62.44 **Tool Club \$49.95**



KDT84783
15pc 1/4" & 3/8" Drive Bolt Biter™ Impact Extraction Set
Sizes: 1/4", 7mm, 8mm [5/16"], 3/8", 10mm, 11mm [7/16"], 12mm, 13- mm [1/2"], 13mm, 14mm [9/16"], 9/16", 16mm [5/8"], 17mm, 11/16", 19mm [3/4"]
Sale \$172.44 **Tool Club \$137.95**



KDT84784
28pc 1/4" & 3/8" Dr. Bolt Biter™ Impact Extraction Socket Set
Sizes: 1/4"-, 1/4", 7- mm, 7mm, 8- mm [5/16"-], 8mm [5/16"], 3/8"-, 3/8", 10- mm, 10mm, 11- mm, 11mm, 12- mm, 12mm, 1/2"-, 13- mm [1/2"], 13mm, 14- mm, 14mm [9/16"-], 9/16", 16- mm [5/8"-], 16mm [5/8"], 17- mm, 17mm, 11/16"-, 11/16".
Sale \$312.44 **Tool Club \$249.95**



KDT86171
16pc Bolt Biter™ Nut Extractor & Driver Set
Sizes: 1/4"-, 1/4", 7- mm, 7mm, 8- mm [5/16"-], 8mm [5/16"], 3/8"-, 3/8", 10- mm, 10mm, 11- mm, 11mm, 12- mm, 12mm, 1/2"-, 13 mm [1/2"].
Sale \$162.44 **Tool Club \$129.95**



KDT86070
5pc 1/2" Dr. Bolt Biter™ Deep Extraction Socket Set
Sizes: 19mm [3/4"] - 25mm [1"]
Sale \$106.19 **Tool Club \$84.95**

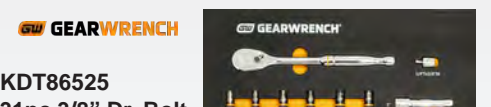

KDT86525
31pc 3/8" Dr. Bolt Biter™ Socket Set
Includes 90 Tooth Ratchet, 3" ext., 1/4"F x 3/8"M adapter & EVA foam tray. Bi-directional design loosens or tightens damaged fasteners. Dual sized sockets designed to work with both SAE/Metric fasteners.
Sale \$262.44 **Tool Club \$209.95**



KDT86190
5 Pc. Bolt Biter™ SAE Wrench Insert Set
1/4", 8 MM (5/16"), 3/8", 11 MM (7/16"), 1/2"
Sale \$37.44 **Tool Club \$29.95**

KDT86191
5 Pc. Bolt Biter™ Metric Wrench Insert Set
8 MM (5/16"), 10 MM, 12MM, 13 MM, 14 MM (-9/16")
Sale \$37.44 **Tool Club \$29.95**

KDT86192
16 Pc. Bolt Biter™ SAE/Metric Wrench Insert Set
-1/4", 7 MM, 8 MM (5/16"), 3/8", 10 MM, 11 MM (7/16"), 12 MM, 1/2", 13 MM, 14 MM (-9/16"), 9/16", 15 MM, 16 MM (5/8"), 17 MM, 11/16", 19 MM (3/4")
Sale \$124.94 **Tool Club \$99.95**

KDT86193
30 Pc. Bolt Biter™ SAE/Metric Wrench Insert Set
-1/4", 1/4", -7 mm, 7 MM, -8 mm (-5/16"), 8 MM (5/16"), -3/8", 3/8", -10 mm, 10 MM, -11 mm (-7/16"), 11 MM (7/16"), -12 mm, 12 MM, -1/2", 1/2", 13 MM, -14 mm, 14 MM (-9/16"), 9/16", -15 mm, 15 MM, -16 mm (-5/8"), 16 MM (5/8"), -17 mm, 17 MM, -11/16", 11/16", -19 mm (-3/4"), 19 MM (3/4")
Sale \$177.44 **Tool Club \$141.95**





OTC6522 LeakTamer™ EVAP Smoke Machine

80% of top codes can be diagnosed with smoke technology. UltraTrace UV dye - OE approved. New smoke flow control adjusts for specific applications. Detects microleaks to & below .010" Sale \$1,599.94 **Tool Club \$1,279.95**



SMOKE MACHINES

MSC43070 Dual Evap / High Pressure Diagnostic Smoke Machine With Truck Adapter Accessory Kit

Sale \$2,499.94 **Tool Club \$1,999.95**



CTA7912 Turbo System Tester

Locates air leaks in the components by plugging the output side of the turbo and plugging the intake inlet Sale \$262.44 **Tool Club \$209.95**



CTA7397 Turbo System Tester HD

Locates leaks in turbo, intake and cooling system. Services Heavy Duty class 6, 7 & 8 vehicles Sale \$187.44 **Tool Club \$149.95**



RED95-0003C Smoke Pro Total Tech

Fid leaks and sell repairs with visual confirmation. Full featured diagnostic capabilities to detect, locate & repair leaks. Sale \$1,312.44 **Tool Club \$1,049.95**

RED95-0030 EASYEVAP™ Universal Filler NeckConnector

In seconds, this versatile adaptor creates an air-tight seal with any vehicle's EVAP system, eliminating the need for searching for the EVAP service port. Sale \$149.94 **Tool Club \$119.95**



LIS69910 14pc Turbo Air System Test Kit with Smoke Adapter

Includes T-adapter for connecting smoke machines to help locate air leaks in the components. Plugs the output side of the turbo and the intake inlet. Air and smoke are applied through one adapter to show the presence of leaks within the system. Can also be used on some cooling system hoses. Sale \$303.13 **Tool Club \$242.50**



LIS72350 Manifold Drill Template for Ford 7.3 Diesel

Removes broken exhaust manifold bolts by drilling without damaging the cylinder head Sale \$174.94 **Tool Club \$139.95**



LIS72400 Manifold Drill Template for Duramax 6.6L Diesel

Removes broken exhaust manifold bolts by drilling without damaging the cylinder head Sale \$174.94 **Tool Club \$139.95**



LIS71350 Ford 6.0L/6.4L Manifold Drill Template

Removes broken exhaust manifold bolts by drilling without damaging the cylinder head Sale \$174.38 **Tool Club \$139.50**

DRILL MANIFOLDS



LIS71500 Dodge 5.7L Hemi Manifold Drill Template

The screw extractor is then used to remove the broken bolt. Includes bushing to drill to tap size when extractor cannot be used. Double sided drill depth gauge to make sure water jacket is not pierced. Sale \$178.13 **Tool Club \$142.50**



LIS71600 Ford 4.6L / 5.4L Manifold Drill Template

Removes broken exhaust manifold bolts by drilling without damaging the cylinder head Sale \$236.19 **Tool Club \$188.95**



LIS68500 Ford Manifold Drill Template

Designed to remove broken exhaust manifold studs on 4.6L, 5.4L & 6.8L V10 2 valve & 3 valve Ford Triton engines without damaging the cylinder head Sale \$131.19 **Tool Club \$104.95**



LIS72600 Dodge 4.7L Manifold Drill Template

Removes broken exhaust manifold bolts on Dodge® 4.7L motors without damaging the cylinder head. Sale \$194.38 **Tool Club \$155.50**



LIS71400 GM 4.8L, 5.3L & 6.0L Manifold Drill Template

Double sided drill depth gauge to make sure water jacket is not pierced. Removes broken exhaust manifold bolts by drilling without damaging the cylinder head. Sale \$157.44 **Tool Club \$125.95**



LIS71650 GM 5.3L & 6.2L Manifold Drill Kit

Removes broken exhaust manifold bolts on GM EcoTech 3 5.3L & 6.2L motors without damaging the Cylinder Head. Removes broken manifold bolts. Sale \$164.69 **Tool Club \$131.75**

O-RING SET



WILW5202
407pc O-Ring Set
SAE Sizes
Sale \$22.44
Tool Club \$17.95

WILW5203
407pc O-Ring Set
METRIC Sizes
Sale \$22.44
Tool Club \$17.95

WILW5201
270pc HNBR
O-Ring Set
For applications requiring higher resistance to chemicals and higher temperatures than NBR.
Sale \$13.13
Tool Club \$10.50

FUSES

TIT45227
96pc ATO Fuse Assortment
For wiring up custom applications and replacing blown fuses.
Sale \$13.13
Tool Club \$10.50



TIT45229
96pc Mini Fuse Assortment
3 Amp to 30 Amp
Sale \$15.63
Tool Club \$12.50



TIT45230
88pc Master Fuse Assortment
Mini & Maxi standard fuses.
Sale \$22.44
Tool Club \$17.95



TIT45232
24pc Maxi Fuse Assortment
Sale \$24.38
Tool Club \$19.50



NEW!

WILW5374
16pc Maxi Fuse Assortment
Sale \$21.19
Tool Club \$16.95



XYZ3216
240pc Self Drilling Screws Black
Sale \$29.94

NEW!

WILW5204
1,000pc Cotter Pin Assortment
Sale \$16.19
Tool Club \$12.95

WILW5214
125pc Rubber Grommet Assortment
Sale \$11.19
Tool Club \$8.95

WILW5215
70pc Grease Fitting Assortment
Sale \$14.94
Tool Club \$11.95

WILW5216
350pc Lock & Flat Washer Assortment
Sale \$9.38
Tool Club \$7.50

WILW5221
347pc SAE Nuts & Bolts Assortment
Sale \$9.38
Tool Club \$7.50

WILW5222
347pc Metric Nuts & Bolts Assortment
Sale \$9.38
Tool Club \$7.50

WILW5226
1,200pc Nut & Bolt Assortment
Sale \$49.94
Tool Club \$39.95

WILW5230
1,000pc Steel Hog Rings
Sale \$13.69
Tool Club \$10.95

WILW5213
160pc Wire Terminal Asst.
Sale \$18.69
Tool Club \$14.95

TIT85527
80pc Poly Rivet Assortment Set
Industrial strength poly rivets protect painted & delicate surfaces.
Sale \$18.69
Tool Club \$14.95

EZRHS34
157pc Heat Shrink Set
8 different size tubes that shrink to fit over cable splices.
Sale \$23.69
Tool Club \$18.95



WILW5220
200pc Hex Washer Self Drilling Screws
Sale \$11.88
Tool Club \$9.50



TIT45274
110 pc Grease Fitting Assortment
Sale \$19.38
Tool Club \$15.50



WILW5208
300pc E-Clip Assortment
Contains 9 various popular sizes.
Sale \$11.19
Tool Club \$8.95



WILW5209
24pc Alligator Clip Assortment
Make your own low voltage jumper leads.
Sale \$12.44 **Tool Club \$9.95**

WILW5200
200pc Spring Assortment
Contains 20 popular sizes of springs.
Sale \$12.44 **Tool Club \$9.95**



HOSE CLAMPS

WILW5348
26pc Hose Clamp Assortment
Sale \$9.94
Tool Club \$7.95



TIT45207
20pc Large Hose Clamp Assortment
Sale \$17.19
Tool Club \$13.75



WILW5231
26pc Key Type Hose Clamps
No tool necessary. 4 different sizes.
Sale \$13.69
Tool Club \$10.95



LATEX GLOVES



NITRILE GLOVES



SAS650-1002 Medium
 SAS650-1003 Large
 SAS650-1004 XLarge
 SAS650-1005 XXLarge
Dyna Grip Latex Gloves
 • Thickness: 7 mil.
 • Beaded cuff.
 • Fully textured for excellent grip.
 • 100 gloves per box.
 Sale \$23.69 **Tool Club \$18.95**

SAS6602 - Medium
 SAS6603 - Large
 SAS6604 - XLarge
 SAS6605 - XXLarge
Thickster Latex Gloves
 • Thickness: 14 mil. 12" length for added protection.
 • Fully textured for superior grip.
 • 50 gloves per box.
 Sale \$23.69 **Tool Club \$18.95**

SAS66517 Medium
 SAS66518 Large
 SAS66519 XLarge
 SAS66520 XXLarge
Raven Nitrile Gloves
 • Thickness: 7 mil.
 • Outstanding strength, wear, and dexterity.
 • Fully textured grip.
 • 100 gloves per box.
 Sale \$27.44 **Tool Club \$21.95**

SAS66472 Medium
 SAS66473 Large
 SAS66474 XLarge
 SAS66475 XXLarge
Astro Grip Nitrile Gloves
 • Thickness: 8 mil.
 • Dual-sided scale textured surface for superior grip.
 • Hi-vis orange color.
 • 100 gloves per box.
 Sale \$27.44 **Tool Club \$21.95**

LIS20130
Glove Box Holder
 Magnets will hold this to a tool box, or mount it to a wall with the holes provided.
 Sale \$32.81
Tool Club \$26.25



SAS6479
Electric Service Glove Kit - XL
 Includes 1 pair of electrical service gloves & protective over gloves.
 Sale \$131.19
Tool Club \$104.95



SAS6478
Electric Service Glove Kit - L
 Includes 1 pair of electrical service gloves & protective over gloves.
 Sale \$131.19
Tool Club \$104.95



MECHANIC'S GLOVES

KDT86987
Heavy Impact Work Gloves - L
 Sale \$37.44
Tool Club \$29.95



- Machine washable.
- Extended cuff with hook and loop closure.
- 90 day limited warranty.

GW GEARWRENCH IMPACT READY

NEW!

LEGACY - GH360 Work Gloves
 Durable, padded polyurethane palm
 Extreme comfort and tactility, Touchscreen.
LEGGH360M - Medium
LEGGH360L - Large
LEGGH360XL - X-Large
 Sale \$23.13 **Tool Club \$18.50**



NEW!

LEGACY - GH500 Winter Gloves
 3M Thinsulate Synthetic Leather warm & breathable
LEGGH500L - Large
LEGGH500XL - X-Large
 Sale \$23.13
Tool Club \$18.50



NEW!

KDT86988
Heavy Impact Work Gloves - XL
 Sale \$37.44
Tool Club \$29.95



LEGACY - GH400 High Dexterity Reflector Gloves
 3M, Scotchlite Reflective Material on knuckle and fingertips
LEGGH400PM - Medium
LEGGH400PL - Large
LEGGH400PXL - X-Large
 Sale \$20.31 **Tool Club \$16.25**



NEW!

LEGACY - GH500 Winter Gloves
 3M Thinsulate Synthetic Leather warm & breathable
LEGGH501L - Large
LEGGH501XL - X-Large
 Sale \$26.19
Tool Club \$20.95



NEW!

LIS89910
Mechanic's Gloves - L
 Non-padded, single layer palm & tough spandex top material
 Sale \$37.44
Tool Club \$29.95



LIS89920
Mechanic's Gloves - XL
 Non-padded, single layer palm & tough spandex top material
 Sale \$37.44
Tool Club \$29.95



LEGACY - GH460PM Leather Work Gloves
 Pro High Dexterity Water-Resistant Hybrid Grain Leather
 Gloves Black/ZillaGreen



NEW!

LEGGH460PM - Medium
LEGGH460PL - Large
LEGGH460PXL - X-Large
 Sale \$29.94 **Tool Club \$23.95**

LEGACY - GC100 Nitrile Dip Gloves
 6 pack of Breathable 100% polyester shell Elastic band cuff
LEGGC100L-6X - Large
LEGGC100XL-6X - X-Large
 Sale \$16.19
Tool Club \$12.95



NEW!

SOCKET HOLDERS

Universal Twist-Lock Socket Set Organizer Tray w/ 2 Socket Rails



Part #	Type	Size	Sale	Club
ERN8461HV	Custom	1/4"	\$25.94	\$20.75
ERN8462HV	Custom	3/8"	\$25.94	\$20.75
ERN8463HV	Custom	1/2"	\$25.94	\$20.75

TITAN Socket Rails are made of anodized aluminum. Magnetic backing.



Part #	Size	Sale	Club
TIT36097	1/4" SAE	\$17.81	\$14.25
TIT36098	1/4" METRIC	\$17.81	\$14.25
TIT38097	3/8" SAE	\$29.06	\$23.25
TIT38098	3/8" METRIC	\$29.06	\$23.25
TIT32097	1/2" SAE	\$31.56	\$25.25
TIT32098	1/2" METRIC	\$31.56	\$25.25

KANSEN Socket Rails are MADE IN USA. Built to hold short and deep sockets.



Part #	Size	Sale	Club
HG1401	1/4" SAE	\$14.06	\$11.25
HG1402	1/4" METRIC	\$14.06	\$11.25
HG3801	3/8" SAE	\$14.06	\$11.25
HG3802	3/8" METRIC	\$14.38	\$11.50
HG1201	1/2" SAE	\$15.63	\$12.50
HG1202	1/2" METRIC	\$15.63	\$12.50

TITAN Socket Rails are spring loaded, color coded & show the socket sizes.



Part #	Size	Sale	Club
CTA9720	1/4" SAE	\$8.44	\$6.75
CTA9725	1/4" METRIC	\$8.44	\$6.75
CTA9730	3/8" SAE	\$8.44	\$6.75
CTA9735	3/8" METRIC	\$8.44	\$6.75
CTA9750	1/2" SAE	\$13.13	\$10.50
CTA9755	1/2" METRIC	\$13.13	\$10.50

ORGANIZER TRAYS

NEW!

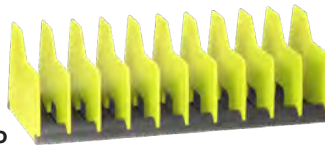

ERN5505HV
10 Tool Plier Pro
Premium rubber base grips tools & drawers. Accommodates a wide variety of tools, holds 10.
Sale \$21.88 **Tool Club \$17.50**

ERNST
MANUFACTURING INC.

NEW!

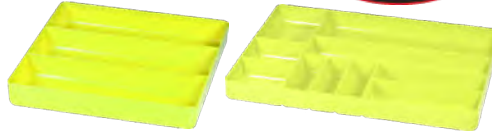

Part #	Space	Size	Sale	Club
ERN5023HV	3	10.5" x 10.5"	\$12.19	\$9.75
ERN5017HV	10	11" x 16"	\$15.63	\$12.50

WRENCH RACKS



EZRFRW12
Flex Magnetic Wrench Rack - Red
Holds 12 wrenches. Individual magnet design holds any size wrench; flex-head and stubbies.
Sale \$43.69 **Tool Club \$34.95**

ERNST
MANUFACTURING INC.



Part #	Pcs.	Type	Size	Sale	Club
ERN5082HV	15	Combo	Custom	\$12.19	\$9.75
ERN5062HV	16	Combo	Custom	\$12.19	\$9.75
ERN5065HV	19	Combo	Custom	\$12.19	\$9.75
ERN5068HV	15	Combo	Custom	\$12.19	\$9.75

ERN8512HV
Socket Boss Hi-Viz Combo Pack
Includes 1/4", 3/8" and 1/2" rails.
Sale \$61.56
Tool Club \$49.25

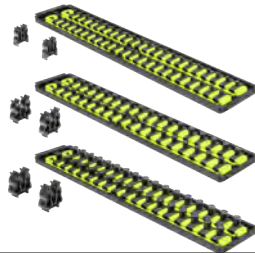

Part #	Pcs.	Type	Sizes	Sale	Club
HG5301	13	SAE	1/4" - 15/16"	\$10.63	\$8.50
HG5302	13	METRIC	6 - 18mm	\$10.63	\$8.50
HG5300	13	Combo	Custom	\$10.63	\$8.50
TIT98013	13	SAE	1/4" - 1"	\$7.44	\$5.95
TIT98012	12	METRIC	8 - 19mm	\$7.44	\$5.95



Will hold up to 13 tools. Two different sizes of slots.

LIS40460
Pliers / Wrench Rack - Black
Sale \$21.56
Tool Club \$17.25

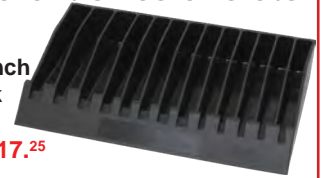

LIS40490
Pliers / Wrench Rack - Red
Sale \$21.56
Tool Club \$17.25



ERN5735HV
Bit Bar Magnetic
18" 96 Tool Magnetic Bit Bar - Black/Hi-Viz
Sale \$24.94 **Tool Club \$19.95**

ERNST
MANUFACTURING INC.

NEW!

LIS49490
24" Locking Tool Holder
Holds up to 13 tools, including pry bars, extensions and air tools.
Sale \$66.88 **Tool Club \$53.50**



MAG RAILS



Part #	Size	Sale	Club
VIMMR8G	8" Green	\$21.19	\$16.95
VIMMR8B	8" Blue	\$21.19	\$16.95
VIMMR8R	8" Red	\$21.19	\$16.95
VIMMR12G	12" Green	\$31.19	\$24.95
VIMMR12B	12" Blue	\$31.19	\$24.95
VIMMR12R	12" Red	\$31.19	\$24.95
VIMMR16G	16" Green	\$36.56	\$29.25
VIMMR16B	16" Blue	\$36.56	\$29.25
VIMMR16R	16" Red	\$36.56	\$29.25
VIMMRD20BK	20" Black	\$82.44	\$65.95
VIMMRBITBASE	38" Base	\$33.69	\$26.95

STUD & T-NUTS FOR MAG RAIL



Part #	Size	Sale	Club
VIMMR-SA	1/4" 10PK	\$4.69	\$3.75
VIMMR-SB	3/8" 10PK	\$5.31	\$4.25
VIMMR-SC	1/2" 10PK	\$6.88	\$5.50
VIMMR-SD	3/4" 10PK	\$8.13	\$6.50
VIMMR-SE	1" 10PK	\$9.06	\$7.25

SUNEX
TOOLS

OTHER
COLORS
AVAILABLE!

25"D x 38"W x 45"H



SUN8057BK - Black Professional Service Cart

- 600lb. Capacity
- Full extension roller bearing drawer slides.
- 6 drawers with locking top bin
- 5" x 2" heavy duty casters; 2 locking
- H.D. 18 gauge steel construction
- Locking top bin with gas shocks to raise and support lid.

Sale \$1,186.88 **Tool Club \$949.⁵⁰**

EXTREME TOOLS
BUILT TO THE EXTREME
44.5"H x 23"D x 33"W

OTHER
COLORS
AVAILABLE!



EXT-EX3304TCRDBK
33" 4 Drawer Deluxe Tool Cart
Red w/ Black Drawer Pulls

- 4 drawers with 3-segment, quick-release ball bearing slides. Rated 100lbs per drawer.

Size: 33"W x 22.875"D x 44.25"H
Sale \$1,465.63 **Tool Club \$1,172.⁵⁰**

Howak
SINCE 1947.

44.1"H x 26.8"D x 42.5"W

NEW!

OTHER
COLORS
AVAILABLE!



HOMGR06044080
44" RS Pro 8 Drawer Flip Top
Power Service Cart

- 8 draw with XL power draw with Power Strip: 2 USB's w/ 4 Outlets & Grommet Cut-Outs

Sale \$2,187.44 **Tool Club \$1,749.⁹⁵**



26"



36"



41"

- Auto return ball bearing slides rated 100lb capacity
- Easy lid opening & closing with gas charged lift supports
- Textured coated paint finish for corrosion, weather & staining resistance

Part #	Size	Desc.	Sale	Club
KDT83240	26"	Top	\$611.88	\$489.⁵⁰
KDT83241	26"	Bottom	\$874.94	\$699.⁹⁵
KDT83242	36"	Top	\$912.44	\$729.⁹⁵
KDT83243	36"	Bottom	\$1,124.94	\$899.⁹⁵
KDT83244	41"	Top	\$937.44	\$749.⁹⁵
KDT83245	41"	Bottom	\$1,499.94	\$1,199.⁹⁵

OTHER
COLORS
AVAILABLE!

GW GEARWRENCH

NEW!

35" L
X
20" W
X
39" H



KDT83246
35" 7 Drawer GSX Series
Rolling Tool Cart with Tilt Top
Built-in charging station with 4 outlets, 2 USB ports and an on/off switch. 20 gauge steel cabinet body. Equipped with black foam liners for each drawer and top storage space. 450lbs weight rating per caster. Sale \$1,437.44 **Tool Club \$1,149.⁹⁵**



H.D. TOOL BOXES

EXTREME TOOLS
BUILT TO THE EXTREME

72"

72" Tool Box w/ 17 Drawer 31" Deep Roller Cabinet

- EXT-EX7217RCQBKBL** Black w/ Blue Drawer Pulls
- EXT-EX7217RCQBKRD** Black w/ Red Drawer Pulls
- EXT-EX7217RCQBLBK** Blue w/ Black Drawer Pulls
- EXT-EX7217RCQGRBK** Green w/ Black Drawer Pulls
- EXT-EX7217RCQORBK** Orange w/ Black Drawer Pulls

- Double-steel wall.
- The full-extension slides can handle 300 lbs. in shallow drawers
- 600 lbs. in deep drawers with double slides
- Double channel spot-welded support brackets to prevent sagging.
- Super Heavy Duty Box - Box Weight (Empty) over 1200Lbs!
- Stainless Steel Top • 6 x 2 Castors that hold up to 900Lbs each

CALL FOR BEST PRICE

EXTREME TOOLS

BUILT TO THE EXTREME



- Full-extension drawers to access every part of the drawer.
- Ball bearing slides loaded rated 100-200 lbs. per drawer.
- Quick Release, self-latching drawer pulls.
- 6" x 2" Mag Wheel Casters that support up to 900 lbs. each.
- 14-gauge steel bottom frame to support a fully-loaded tool box.
- Matching side handles & trim. Professional quality PVC drawer liners.

Shown with Hutch and Side Box



72" Tool Box w/ 17 Drawer 21" Deep Roller Cabinet

- EXT-DX722117RCBKBL
- EXT-DX722117RCBKRD
- EXT-DX722117RCBLBK
- EXT-DX722117RCGRBK
- EXT-DX722117RCMBBK
- EXT-DX722117RCORBK

- Black w/ Blue Drawer Pulls
- Black w/ Red Drawer Pulls
- Blue w/ Black Drawer Pulls
- Green w/ Black Drawer Pulls
- Matte Black w/ Black Drawers
- Orange w/ Black Drawer Pulls

Sale \$2,998.75
Tool Club \$2,399.00

72"W x 21"D x 42.75"H
 Tubular Coded Lock and Keys

Tool Box Hutch
 EXT-DX722101HCBKBL
 Deep Triple Bank Hutch Black w/ Blue Handle / Drawer Pulls

71 15/16"W x 21"D x 22 1/4"H
 Sale \$1,499.06
Tool Club \$1,199.25

Side Box
 EXT-DX192100SLBKBL
 Deep Side Locker with 4 Shelves Black w/ Blue Handle

19"W x 21"D x 56.34"H
 Sale \$1,437.44
Tool Club \$1,149.95

Tool Box, Hutch & Side Box: **Tool Club \$4,699.95**

EXTREME TOOLS

BUILT TO THE EXTREME

41" TOOL CART / BOX

41.75W x 25.75"D x 43"H



- 6 Drawers
 - Only One Drawer Opens at One Time
 - 100 lbs Drawer Capacity per Set of Slides
 - PVC Drawer Liners Included
 - Tubular Coded Locks and Keys
 - Drawers Can be Opened without Top Lid Open
 - Standard 4 Position Power Tool Holder Included
- Sale \$2,312.44 **Tool Club \$1,849.95**

- EXT-EX4106TCBKBL
 - EXT-EX4106TCBKRD
 - EXT-EX4106TCBLBK
 - EXT-EX4106TCGRBK
 - EXT-EX4106TCMBBK
 - EXT-EX4106TCORBK
 - EXT-EX4106TCRDBK
- Black w/ Blue Drawer Pulls
 - Black w/ Red Drawer Pulls
 - Blue w/ Black Drawer Pulls
 - Green w/ Black Drawer Pulls
 - Matte Black w/ Black Drawers
 - Orange w/ Black Drawer Pulls
 - Red w/ Black Drawer Pulls

ALL EXTREME BOXES ARE AVAILABLE!

TOOL BOXES

CHAIN HOISTS

APP635
3 Ton
Lever Hoist
5' lift.
Sale \$498.13
Tool Club \$398.⁹⁵



APP635 APP450 APP660

APP450
5 Ton
Chain Hoist
10' lift.
Sale \$656.19
Tool Club \$524.⁹⁵

APP660
6 Ton
Lever Hoist
5' lift.
Sale \$787.44
Tool Club \$629.⁹⁵



ENGINE TILTERS

AFF582
Engine Tilter
Sale \$124.94
Tool Club \$99.⁹⁵



APPP7134
Engine Lift Sling
600 lb capacity.
Sale \$34.94
Tool Club \$27.⁹⁵



WILW41034
Engine Lift Plate
Sale \$18.44
Tool Club \$14.⁷⁵

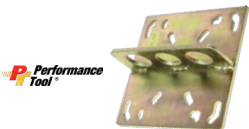

REPLACEMENT RAMS

AFFLRC3B 3 Ton
Sale \$199.94
Tool Club \$159.⁹⁵



AFFLRC8B 8 Ton
Sale \$249.94
Tool Club \$199.⁹⁵



ENGINE HANGERS

AFF583
Engine Hanger
Adjusts: 26" to 49"
1,250 lb capacity
Sale \$249.94
Tool Club \$199.⁹⁵



SUN5207
Engine Transverse Bar with Arm Support
For supporting a transverse engine during service.
Transverse bar extends from 34.5 to 61"
Sale \$237.44 **Tool Club \$189.⁹⁵**



ENGINE CRANES

WILW41029
2 Ton Folding
Engine Crane
Adjustable boom w/
chain & hook. Legs
fold for easy storage.
Sale \$612.44
Tool Club \$489.⁹⁵



THA67020
2 Ton Folding
Engine Crane
Adjustable boom w/
chain & hook. Legs
fold for easy storage.
Sale \$749.94
Tool Club \$599.⁹⁵



AFF3583
2 Ton Folding
Engine Crane
Folds up for
easy storage.
Includes heavy duty
8 ton ram. weights
225lbs
Sale \$687.44
Tool Club \$549.⁹⁵



AFF3584
3 Ton Folding
Engine Crane
Rear of crane is 61.5" tall
and 33" wide. Reinforced
leg assemblies for added
strength and durability
Sale \$1,349.94
Tool Club \$1,079.⁹⁵



ENGINE STANDS

WILW41031
1250 lb. Capacity
Engine Stand w/ Tray
Head rotates 360° and
locks in 6 positions.
Securely holds most foreign
and domestic engine blocks.
Sale \$224.94 **Tool Club \$179.⁹⁵**



SUN8400
1 Ton Capacity
Engine Stand
Thick, reinforced
mounting plate.
8 Locking angles.
Sale \$466.88
Tool Club \$373.⁵⁰



THA67106
1,000 lb.
Capacity
Engine Stand
Head rotates 360°
and locks in 8 positions.
Securely holds
most foreign
and domestic
engine blocks.
Sale \$187.44
Tool Club \$149.⁹⁵



AIR/HYDRAULIC JACKS

AFF5520B
20 Ton
Range: 10-1/2" to 20"
Sale \$337.44
Tool Club \$269.⁹⁵



AFF5621SD
20 Ton Low Profile
Super Duty
Range: 7" to 12-3/4".
1-1/8" thick base.
Sale \$474.94
Tool Club \$379.⁹⁵



AFF5620SD
20 Ton Super Duty
Range: 10-3/8" to
20-5/8".
1-1/8" thick base.
Sale \$474.94
Tool Club \$379.⁹⁵



AFF5630SD
30 Ton Super Duty
Range: 11" - 20.6"
1-1/8" thick base.
Sale \$612.44
Tool Club \$489.⁹⁵



BOTTLE JACKS



1 YEAR WARRANTY FOR ALL BOTTLE JACKS

Part #	Capacity (TONS)	Range	Sale	Club
AFF3502	2	6.25" - 12.75"	\$40.63	\$32.⁵⁰
AFF3504	4	6.5" - 13.25"	\$49.94	\$39.⁹⁵
AFF3506	6	8" - 16"	\$58.69	\$46.⁹⁵
AFF3508	8	7.75" - 15.5"	\$76.88	\$61.⁵⁰
AFF3512	12	8.5" - 17"	\$99.94	\$79.⁹⁵
AFF3514	12 Low	7" - 13"	\$99.94	\$79.⁹⁵
AFF3520	20	9.4" - 18.25"	\$174.94	\$139.⁹⁵
AFF3522	20 Low	7.75" - 14.25"	\$174.94	\$139.⁹⁵
AFF3530	30	11" - 18.6"	\$374.94	\$299.⁹⁵
AFF3550	50	12" - 19"	\$593.75	\$475.⁰⁰



BOTTLE JACKS



Part #	Capacity (TONS)	Range	Sale	Club
WILW1621	2	7 1/8" - 13 1/2"	\$28.13	\$22.⁵⁰
WILW1625	6	8 1/2" - 16 1/4"	\$45.63	\$36.⁵⁰
WILW1628	8	9" - 18"	\$61.88	\$49.⁵⁰
WILW1632	12	9 1/4" - 18 1/2"	\$72.81	\$58.²⁵
WILW1633	20	9 1/2" - 17 3/4"	\$109.38	\$87.⁵⁰
WILW1644	20 Low	7 1/2" - 13 1/8"	\$99.94	\$79.⁹⁵

UNDERHOISTS

SUN6809A
Underhoist Stand
750lb capacity
53" - 79"
Sale \$162.44
Tool Club \$129.95

SUN6810A
Underhoist Stand
with Pedal
750lb capacity
53-3/4" - 78-7/8"
Sale \$181.25
Tool Club \$145.00

THA63007
Auxiliary Stand
750lb ton capacity. 53.5" - 80"
Sale \$174.94
Tool Club \$139.95

THA63008
Auxiliary Stand with Pedal
750lb ton capacity. 53.5" - 80"
Sale \$187.44
Tool Club \$149.95

THA63020
4,000 High-Reach
Supplementary Stand
Height adjustment spin handle
that provides easy adjustment
of work height.
Min height 48in Max 84.5in
Sale \$187.44
Tool Club \$149.95



TRANSMISSION JACK

SUNEX
TOOLS

SUN7700C
700lb H.D.
Pedestal Telescopic
Transmission Jack
Range: 50.8" - 70.5"
Manual piston pump.
90 Day Warranty
Sale \$412.44
Tool Club \$329.95

THA65100
1,000LB Ton Transmission Jack
2 Stage telescopic design.
Saddle adjusts to multiple
angles. Min/Max Height:
33.4375" / 70.625"
Sale \$1,124.94
Tool Club \$899.95

SUNEX
TOOLS

SUN7793B
1,000lb.
Transmission Jack
2 Stage telescopic design.
Range 36.4375 to 70.625"
Sale \$1,237.44
Tool Club \$989.95

AFF3102A
2,000lb. Air & Manual
Transmission Jack
2 Stage telescopic design.
Range: 37" to 76"
Double pump hydraulic
lift system.
Sale \$1,562.44
Tool Club \$1,249.95

OTC5078
2,000 IB. Air Operated
Transmission Jack
Used on Trucks and Buses
Low height of 41-1/2"
Max Height 65"
**CALL FOR
BEST PRICE**

SUNEX
TOOLS

SUN7750C
1,200 lb.
Low Profile
Transmission Jack
Min Height 6.3 Max Height 31.5"
Dimensions 38.34 x 20.47 x 8.03 in
Sale \$762.44 **Tool Club \$609.95**

THA65305
1,500 lb. Ton Transmission Jack
360° Rotating Pump socket
Min Height 7-7/8" Max Height 36-3/16"
Weights 308Lb
Sale \$1,349.94 **Tool Club \$1,079.95**

AFF3180
4,400 lb. Jack
Only transmission jack available with a
4,400 lb. capacity. Range: 8-1/2" to 34".
Sale \$1,999.94 **Tool Club \$1,599.95**

OTC5019A
2,000lbs Transmission Jack
Min. height - 8-1/4 in
Max. height - 36-1/2 in
Max. forward tilt - 15 deg
Max. backward tilt - 20 deg
L 52" x 32.5" w x 36.5" H
Sale \$3,624.94
Tool Club \$2,899.95

AFF3700
500 lbs Clutch Jack
One-man operation for
removal of heavy duty
truck clutches.
(2" OD x 1.18" &
1.75" OD x .938 pilot)
Low Height 13" Max Height 39"
Sale \$862.44 **Tool Club \$689.95**



POWER TRAIN LIFT

AFF3182
2,500lb
Power Train Lift / Table
Can be used as a work
table or lift. 4 safety
latches. Air assist foot
pump with air extension.
Height: 33" - 77".
Sale \$6,249.94
Tool Club \$4,999.95

OTC5295
Powertrain Lift
Lifting Height
Range: 21.5" - 70.0".
Capacity: 1,760 lbs.
Sliding split table top design
allows for separation of the engine/
transmission assembly or hybrid
engine/generator
module. Designed
to handle removal &
installation of electric
vehicle batteries, fuel
tanks, suspension
systems & future
powertrains.
Tilting table provides alignment correction.
CALL FOR BEST PRICE



TRANS / DEF JACKS

3 TON JACK STANDS

OTCS03
3 Ton Ratcheting Jack Stands
 Range: 12" - 17-11/16".
 Self-locking ratchet handle.
 V-notch style saddle.
 Sold In Pairs.
 Sale \$93.69
Tool Club \$74.95



AFF3303
3 Ton Jack Stands
 Range: 12" to 18"
 Self-locking ratchet handle. Sold In Pairs.
 Sale \$82.44
Tool Club \$65.95



THA63030
3 Ton Jack Stand
 Range: 11"-16-5/16"
 Self-locking ratchet handle. Sold in Pairs
 Sale \$59.94
Tool Club \$47.95



6 TON JACK STANDS

OTCS06
6 Ton Ratcheting Jack Stands
 Range: 15-5/8" - 23-11/16".
 Self-locking ratchet handle.
 V-Notch style saddle.
 Sold In Pairs.
 Sale \$162.44
Tool Club \$129.95



AFF3306
6 Ton Jack Stands
 Range: 15-3/4" to 24-3/4"
 Sold In Pairs.
 Sale \$149.94
Tool Club \$119.95



THA63060
6 Ton Jack Stands
 Range: 15-3/4 - 24-3/8"
 Self-locking ratchet handle. Sold In Pairs.
 Sale \$124.94
Tool Club \$99.95



TRUCK STANDS

15,000 LB. CAPACITY.
 Rubber pad protects the vehicle from damage. Spring loaded casters for ease of positioning.



AFF3344SD
15,000lb. Truck Stand - Short
 Range from 36" to 54".
 17-1" height adjustments.
 Sale \$1,249.94
Tool Club \$999.95

AFF3342SD
15,000lb. Truck Stand - High
 Range from 57" to 82".
 17-1" height adjustments.
 Sale \$1,249.94
Tool Club \$999.95

12 TON JACK STANDS

AFF3312B
12 Ton Jack Stands
 Range: 19-1/2" to 28".
 13" x 11-5/8" base.
 Notched saddles.
 Sold in pairs.
 Sale \$299.94
Tool Club \$239.95



THA63120
12 Ton Jack Stands
 Min 19-11/16
 Max 30-5/16".
 Sold in pairs
 Sale \$262.44
Tool Club \$209.95



10 TON H.D JACK STANDS

AFF3309B
HD 10 Ton Jack Stand
 Range: 18-1/2" to 30"
 Pin-type post adjusts to 7 positions.
 Sold in pairs.
 Sale \$449.94
Tool Club \$359.95



THA63101
HD 10 Ton Jack Stand
 Min 18-15/16
 Max 30-1/2".
 Sold in pairs
 Sale \$418.69
Tool Club \$334.95



AFF3310B
HD 10 Ton High Jack Stand
 Range: 28" to 47"
 3-1/8" x 5-7/8" support saddle & 16" x 16" base.
 Ten height positions.
 Sold in Pairs
 Sale \$612.44
Tool Club \$489.95



THA63102
HD 10 Ton High Jack Stand
 Min 29"
 Max 47-3/4".
 Sold in pairs
 Sale \$499.94
Tool Club \$399.95



22 TON H.D JACK STANDS

OM32225B
22 Ton Heavy Duty Truck Stands
 Welded steel construction prevents distortion or twisting.
 Range: 12-1/4" to 19-7/8"
 Sale \$424.94
Tool Club \$339.95



AFF6422
22 Ton Pin Style Jack Stand Set
 Range: 11.8" - 19.7"
 10" x 10" base.
 V-shaped saddles.
 Sold In pairs.
 Sale \$324.94
Tool Club \$259.95



THA63220
22 Ton Jack Stands
 Min 13-5/16"
 Max 19-5/8"
 10" x 10" base.
 Sold in pairs
 Sale \$324.94
Tool Club \$259.95



LOW-PROFILE JACKS

WILW1642
2 Ton Low Profile Jack
Range: 2-3/4" - 20"
Sale \$274.94
Tool Club \$219.95



AFF200T
2 Ton H.D. Low Profile Service Jack
Range: 2.75" - 20"
Sale \$462.44
Tool Club \$369.95



WILW1645
3.5 Ton Low Profile Jack
Range: 3-1/2" - 20-1/2"
Sale \$374.94
Tool Club \$299.95



THA33502F
3.5 Ton "Quick-Start" Service Jack
Range: 3-3/4" - 21-3/4"
"Quick-Start" technology for One-Pump-To-Contact effortless performance. Padded saddle for vehicle protection. Heavy Duty U-Joint mechanism. Heavy Duty & reinforced chassis & lift arm.
Sale \$374.94 **Tool Club \$299.95**



THA62021
2 Ton Super Long Reach Low Profile Jack
2.75" to 24" Double pump piston 1pc handle
Sale \$474.94 **Tool Club \$379.95**

WHEEL DOLLY



PROT3310
Wheel Dolly (PAIR)
1,000lb Capacity (each). Fits 12" wide tires
Sale \$124.94 **Tool Club \$99.95**



WILW54013
Wheel Dolly (PAIR)
1,000 lb. capacity (each). Fits 14" wide tires.
Sale \$124.06 **Tool Club \$99.25**

FLOOR JACKS

THA62035
3.5 Ton Jack
3.75" to 21.75"
Double pump piston 1pc handle
Sale \$374.94 **Tool Club \$299.95**



AFF400SS
4 Ton HD Floor Jack
Heavy Duty Steel Construction. Twin hydraulic system for maximum speed. Pinned and padded saddle. Range: 4.3" - 20.5".
Sale \$499.94
Tool Club \$399.95



AFF53350JPK
3.5 Ton Jack & 6 Ton Jack Stand Combo
Jack range: 5-1/8" - 21".
Doublepump hydraulic system.
Jack Stands: Max Height: 34-3/4".
Sale \$499.94 **Tool Club \$399.95**

ALUMINUM JACKS

THA31501
1.5 Ton Aluminum Transmission Jack
Range: 3.15" - 14".
Double pump design. Hydraulic oil by-pass system.
Sale \$218.69
Tool Club \$174.95



THA60020
2 Ton Aluminum Service Jack
3.25" to 18.5"
Light weight, Double pump design
Sale \$499.94
Tool Club \$399.95



AFF210
3 Ton Aluminum Service Jack
Range: 3.75" - 19.3".
Double pump design.
Sale \$562.44 **Tool Club \$449.95**



SUNNSJ0302
3 Ton Aluminum Service Jack
3.75" to 19"
Light weight, Double pump design
Sale \$499.94 **Tool Club \$399.95**



OMEGALIFT

OM47020
2,000 lb 3-in-1 Car Dolly Set (PAIR)

- Holds vehicle by the wheel, by the pinch weld, or by the frame.
- No adapters required.
- Integrated frame adapters.
- Locking casters.
- No tools required.
- Adapter secured with pins.
- Self-stacking.
- Allows convenient storage.
- Sold in pairs of 2.

Sale \$599.94 **Tool Club \$479.95**



GOJAK

THE FASTER CASTER SYSTEM



GOJACK7016
1,750 lb. SUV GOJAK (EACH)
Max tire width: 16". For light duty Class 1 & 2 trucks and SUVs.
1,750 lb capacity per wheel.
Sale \$512.44
Tool Club \$409.95

GOJACK6313
1,574 lb. GOJAK (EACH)
Fits tires up to 13" wide. With a ratcheting mechanism.
Sale \$424.94
Tool Club \$339.95

GOJACK567R
Go-Jak™ Storage Rack Cart
Fits all Go-Jak™ models. Loads & unloads in seconds. Go-Jaks not included.
Sale \$162.44
Tool Club \$129.95

FLOOR JACKS



HW93657USA 4 Ton HD Long Chassis Manual Service Jack

Handle adjusts to three pumping positions. Height Range: 5" - 25-3/4".
Sale \$3,749.94
Tool Club \$2,999.95



AFF3120 5 Ton Long Chassis

Extra long chassis. Range: 6" to 22.5".
Foot operated pump. Handle locks in 3 different positions.
Sale \$1,312.44
Tool Club \$1,049.95



AFF3135 10 Ton Air/Hydraulic Jack

Use by hand or with shop air. Range: 7" to 23".
Sale \$2,124.94
Tool Club \$1,699.95
FREE SHIPPING!



THA62100 10 Ton Long Chassis Manual Service Jack

Range: 6-1/4" - 27". Welded hydraulic assembly to assure strength & eliminate leaks. Built-in bypass system prevents the ram from over-extending. T-Handle with 3 locking positions (90°, 45° & 0°).
Sale \$1,687.44
Tool Club \$1,349.95



AFF3225 20 Ton Air/Hydraulic Long Chassis Jack

Extra long chassis. Range: 7.5" - 26.375".
3 lever locking positions. Air motor designed for use with compressed air between 90-120PSI.
Sale \$3,994.94
Tool Club \$3,195.95



TRUCK RAMPS

THA69201 20 Ton Wide Truck Ramps

Dimensions: 45-3/8" x 18-1/4" x 9-1/2". Large wheel designs for extra durability. Non-skid rubber matting. Long retractable T-handle. Designed specifically for heavy duty tasks. Wide design.
Sale \$1,124.94 **Tool Club \$899.95**



SOLD
IN
PAIRS

AIR - OPERATED JACKS

OTCUA22
22 Ton Under Axle Jack
90 - 145 PSI.
Reach: 69.87".
Lifting Range: 8.27" - 20-2/3".
Includes 3 attachments for adjusting height.
Sale \$1,087.44
Tool Club \$869.95



AFF565F
22 Ton Air Assist
Truck Axle Jack
90 - 180 PSI.
Lifting Range: 8-1/4" - 21-1/2"
Includes 3 attachments for adjusting height.
Sale \$849.94
Tool Club \$679.95



AFF56220A
22 Ton Air Assist Truck Axle Jack
Low height: 10-1/2".
Max Height: 17-3/4". 61" reach.
Narrow chassis design fits easily between tandem wheels
Sale \$774.94
Tool Club \$619.95



THA62220
20 Ton Air Operated Axle Jack
Low height 9". Max height 18".
Built-in bypass device to protect hydraulic system from over pumping damage. Built-in muffler to promote quiet operation. High speed turbo motor for efficient effortless operation.
Sale \$724.94
Tool Club \$579.95



2 / 3 STAGE AIR / HYDRAULIC JACKS

EXTRA LONG HANDLES
INCLUDES HEIGHT ADAPTERS
SINGLE PIECE BASE

FREE SHIPPING!



Part #	Capacity (TONS)	Range	Sale	Club
AFF545SD	30 / 15	5.92" - 11.5"	\$1,994.94	\$1,595.95
AFF546SD	25 / 10	7.28" - 14.84"	\$2,499.94	\$1,999.95
AFF547SD	50 / 25	8.46" - 23.31"	\$3,249.94	\$2,599.95
AFF548SD	60/40/20	6.89" - 15.91"	\$3,749.94	\$2,999.95
AFF549SD	80 / 50	9.06" - 17.32"	\$3,993.75	\$3,195.00

END LIFTS



10
TON

AFF3598
10 Ton End Lift
10 ton capacity for lifting large trucks or trailers.
Range: 17-1/2" to 50"
Sale \$4,749.94
Tool Club \$3,799.95
FREE SHIPPING!



OTHER
MODELS
AVAILABLE!

BENDXPR10AS
2 Post 10,000-lb. Capacity / Asymmetric Clearfloor
A - Rise: 69" (1,753 mm)
B - Rise + Pad Only: 73" (1,854 mm)
C - Rise + Pad + 63 mm Adapter: 79" (2,007 mm)
D - Min. Height + Pad: 4" (102 mm)
Time to Full Rise: 45 seconds
CALL FOR BEST PRICE

Powertrain Lifting



NEW!



BENDEV4000SL
EV Battery Pack And Powertrain Lifting System / Portable Scissors / Full-Rise Lifting Height 75.75"
Platform Capacity 4,000 lbs.
Overall Length 90"
Overall Length (Handle Stowed) 65"
Overall Width 46" (1,168 mm)
Platform Size 40" x 60"
Stowed Height 21.5"
Raise / Lower Time (Max. Rise) 18 seconds
Power Source 12V deep cycle DC battery
Weight 1,076 lbs. (489 kg)
CALL FOR BEST PRICE

CREEPERS



LIS94102 - Blue



LIS93102 - Yellow



LIS92102 - Red



LIS93202 - Orange



LIS99102 - Green



LIS97102 - Black



PLASTIC CREEPERS

Sale \$112.44 **Tool Club \$89.95**

Strong low profile creepers feature 6 wheels and a comfortable curved shape. 300lb capacity.

CREEPERS

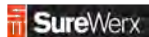

AFF57100
Viking HDPE Mechanic Creeper
Six (6) rollerskate-style wheels.
42" Super Low Profile. 440lb capacity.
Sale \$137.44 **Tool Club \$109.95**

WILW85006
Plastic Creeper
Comfortable curved shape.
Sale \$71.19
Tool Club \$56.95



WILW85005
Adjustable Headrest Padded Creeper
With strong metal frame.
Sale \$74.94 **Tool Club \$59.95**



WILW85038
High Top Adjustable Creeper
Adjustable Creeper height 45 to 66".
Maximum 400lb weight capacity.
Four swivel casters, two locking.
18" x 12" padded deck. Folds up for easy & compact storage.
Heavy Duty steel construction.
Sale \$324.94
Tool Club \$259.95



WILW4991
3 pc. Power Tool Brush Set
2", 4" round flat brushes
3-1/2" dome shaped brush
Sale \$12.44 **Tool Club \$9.95**



WILW4992
16 pc. Power Brush Detailing Kit
assortment of brushes, pads and towels to make detailing your auto, boat or home.
Sale \$24.94 **Tool Club \$19.95**



SUN8509
SUNEX TOOLS
Pneumatic Shop Seat
Air cylinder raises height up to 20.5"
Sale \$98.69
Tool Club \$78.95



SUN8507
SUNEX TOOLS
Creeper Seat
Cushioned vinyl seat with 2" high compression foam
Sale \$63.13
Tool Club \$50.50



WILW85035
Rolling Storage Garage Seat
Oversized 19-inch seat features vinyl foam.
Extra large storage sides.
300lb weight capacity
Sale \$87.44 **Tool Club \$69.95**



SUN8514
Padded Tractor Seat
Very comfortable. Adjusts 18" to 22". Includes 17" tool tray.
Sale \$174.94
Tool Club \$139.95



SUN8516
Adjustable Shop Seat
Cushioned seat. Perfect for shop or garage use.
Sale \$162.44
Tool Club \$129.95



WILW85011
Pneumatic Swivel Bar Stool
Adjusts from 26" - 32".
360° swivel. 330 lb weight capacity.
Sale \$87.44
Tool Club \$69.95



WILW85007
Creeper Seat
Includes tray.
Sale \$49.94
Tool Club \$39.95



WILW88981
Anti-Fatigue Grip Mat Roll
Protects your floors from damage
46 in. x 93 in. x 9/32 in.
Approximately 30 square feet
Sale \$37.44 **Tool Club \$29.95**



WILW85024
2 Drawer Rolling Mechanics Seat
Flip top tool chest w/ 2 sliding drawers.
350 lb capacity. Dual side trays. 2-1/2 inch full bearing casters.
Sale \$124.94
Tool Club \$99.95



WILW88977
Neoprene Protective Work Mat
Oversized mat provides a protected work space on your work bench, kitchen table or computer desk space
16" x 35.75 x 1/8" thick
Sale \$15.63 **Tool Club \$12.50**

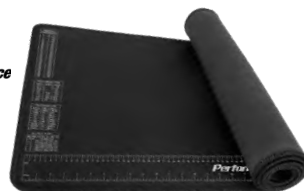

WILW12525
Magnetic Cup Holder
3-5/8" diameter hold up to 8 pounds
Sale \$6.19 **Tool Club \$4.95**



LIS95002
Folding Pad
Sale \$52.44
Tool Club \$41.95



EPPFENDERBLACK
Fender Cover
Sale \$16.19
Tool Club \$12.95



MANUAL SHOP PRESSES

AFF820A

20 Ton Manual Shop Press

- For light auto & industrial use.
- HD return springs for fast ram retraction.
- Two press plates & bearing punch.
- 61" tall with a 27" base width.
- Eight level bed adjustment.

Sale \$1,249.94 **Tool Club \$999.95**



WILW41062

12 Ton Commercial Shop Press

- 7 Adjustable Height Locations.
- 12 Ton Capacity.
- Remote pressure cylinder with relief valve.
- Liquid-Filled 4" pressure indicator gauge.
- 65" overall height.
- 152lbs overall weight

Sale \$549.94 **Tool Club \$439.95**



WILW41063

20 Ton Commercial Shop Press

- 9 Adjustable Height Locations.
- 20 Ton Capacity.
- Remote pressure cylinder with relief valve.
- Liquid-Filled 4" pressure indicator gauge.
- 69" overall height, 19.5-in inside Frame, 7.5-in Stroke.

Sale \$612.44 **Tool Club \$489.95**



HEAVY DUTY SHOP PRESSES

FREE SHIPPING ON ALL SUPER DUTY PRESSES

Feature welded frame & heavier gauge steel for heavy duty truck applications, spring shops, industrial, or those in need of a "step up" from a regular duty press.

AFF850ASD

20 Ton Capacity

Sale \$2,243.75
Tool Club \$1,795.00



AFF852ASD

30 Ton Capacity

Sale \$2,999.94
Tool Club \$2,399.95



INCLUDES
ACCESSORY KIT

AFF854ASD

50 Ton Capacity

Sale \$4,999.94
Tool Club \$3,999.95

AFF856ASD

75 Ton Capacity

Sale \$6,868.75
Tool Club \$5,495.00

AFF859ASD

100 Ton Capacity

Sale \$11,249.94
Tool Club \$8,999.95



SUN57KIT6

6pc Press Accessory Kit

For presses up to 50 ton.
1/2", 1" & 2" punches.
Bearing shield. Two steel plates.
Sale \$182.19 **Tool Club \$145.75**



SUNEX
TOOLS

SUN57KIT8

8pc Press Punch Kit

For presses up to 50 ton.
1/2", 3/4", 1", 1-1/2", & 2" punches.
Bearing shield. Two steel plates.
Sale \$286.56 **Tool Club \$229.25**



WORK BENCHES

TIT21009

Professional Workbench

Durable powder-coated finish.
Full bottom shelf.
Weight capacity: 1,200 lbs.
Top panel: 13 gauge steel.
Bottom shelf: 13 gauge steel.
Steel support: 12 gauge steel.
Sale \$499.94

Tool Club \$399.95



TIT21006

60" Work Bench

60"W x 31"D x 34"H
Full bottom shelf.
1,200 lb weight capacity.
Sale \$499.94

Tool Club \$399.95



TIT21005

Work Bench Wheel Set

Sale \$66.19 **Tool Club \$52.95**



SUN8019

Deluxe Work Table

Easy to maneuver 2" casters.
1" deep drawer for convenient storage. On-board screwdriver & pry bar holder. Air Tool hose cut-outs. Durable textured rubber mat for non-skid surface. Adjustable table height from 34" - 47.75".
Sale \$214.06 **Tool Club \$171.25**

SUNEX
TOOLS



SUN8034

Standard Plastic Utility Cart

500 lbs weight rating. 4 storage bins.
Dimensions: 32.28 x 18.5 x 8.66 in
Sale \$262.44 **Tool Club \$209.95**

SUN8036

Large Plastic Utility Cart

500 lbs weight rating. 5 storage bins.
Dimensions: 32.28 x 18.5 x 8.66 in
Sale \$349.94 **Tool Club \$279.95**



Astro Pneumatic

AST8330

H.D. Plastic 2 Shelf Utility Cart

3-1/2" deep trays & can hold up to 300 lbs.
Size: 16"(W) x 30"(L) x 31"(H).
Made of Polypropylene.
Sale \$124.94
Tool Club \$99.95

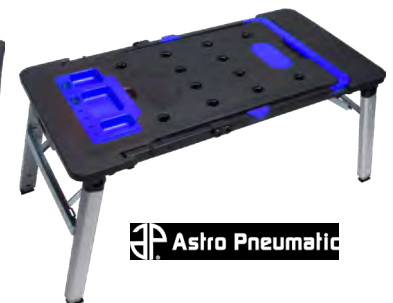

AST55670

7-in-1 Workbench

Includes: Workbench, saw horse, scaffold, platform, car creeper, dolly and hand truck. 550lb max capacity in scaffold & platform mode. 330lb max capacity in other modes. Includes integrated power strip. 43"x21.75" work surface. 20.5" to 30.75" working height.
Sale \$218.69 **Tool Club \$174.95**

Astro Pneumatic



WLT28806
5-1/2" Tradesman Vice
 60,000 PSI ductile iron casting. Fully enclosed spindle & nut. Large anvil. Replaceable jaws. 360° swivel base w/ double lockdowns. Jaw Width: 5.5" Jaw Opening: 5" Sale \$999.94
Tool Club \$799.95



WLT28807
6-1/2" Vice w/ Reversible Top Jaws
 Jaw Width: 6-1/2" Pipe Capacity: 3/8" to 3-1/2" Throat Depth: 4-3/4" Sale \$1,124.94
Tool Club \$899.95



WLT28828
8" Trade Vice
 60,000 PSI. Jaw Width: 8" Jaw Opening: 7" Throat Depth: 4-3/4" Pipe Capacity: 1/8" to 3-1/2" Sale \$3,243.75
Tool Club \$2,595.00



JET577172
HD Bench Grinder Pedestal
 31" high. Pre-drilled holes for floor mounting. Sale \$262.44
Tool Club \$209.95



SUN5003
Bench Grinder Pedestal
 Pre-drilled holes for floor mounting. 27.5" high. Sale \$119.06
Tool Club \$95.25



WLT11114
400CS 4pc Hi-Vis C-Clamp Kit
 Sizes: 2", 4", 6" & 8". Clamps down with up to 6,900lbs of force! Sale \$172.19
Tool Club \$137.75



WLT11128BH
6-1/2" High-Viz Safety Vice w/ FREE Hammer
 6.5" Jaw Width. Large anvil work surface. Special edition high-viz paint color. Includes FREE WLT20412 - 12" 4 lb head BASH sledge hammer. Sale \$331.19
Tool Club \$264.95



TRAILER HITCH MOUNT

WLT10025BH
5" ATV All Terrain Vice w/ 2.5lb Sledge Hammer & Mounting Bracket
 Can be mounted on a bcor standard 2" trailer hitch. Lightweight with carrying handle. Water resistant for all weather. Large striking surface. Clamps objects up to 5". Sale \$331.19
Tool Club \$264.95



WLT28821
5-1/2" Reversible Bench Vice
 360° Swivel Base. Jaw opening expands to an incredible 10-3/4" when reversed. Sale \$424.94
Tool Club \$339.95



TIT22016
6" Bench Vice
 Forged steel beam. Swivel base w/ position lock. Sale \$199.94
Tool Club \$159.95



TIT22018
8" Swivel Base Vice
 Replaceable hardened steel jaws. Precision cast iron beam. Sale \$374.94
Tool Club \$299.95



BENCH GRINDERS



SUN5002A
8" Bench Grinder with Light
 H.D Cast iron base with 36 & 60 grit wheels. 40 watt flex light with eye shield. Sale \$261.19
Tool Club \$208.95



WILW50058
8" Bench Grinder
 Cast iron housing. 3/4 HP UL approved. 115 volt, 60 Hz & 3,450 RPM. Wide, clear, easy to adjust eye shields. Ball bearings for durability. 1 fine and 1 coarse wheel included. Sale \$137.44
Tool Club \$109.95



H.D. GRINDERS

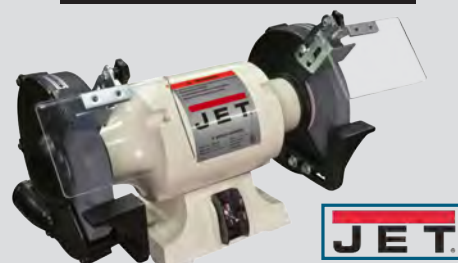

- Totally enclosed pre-lubricated ball bearings.
- Rubber mounts prevent movement.
- H.D. guarded toggle switch.
- Cast iron wheel guards and dust vents.
- Fine and coarse vitrified grinding wheels.

Part #	Size	HP	RPM	Sale	Club
JET577101	6"	1/2	3,450	\$387.44	\$309.95
JET577102	8"	1	3,450	\$511.88	\$409.50
JET577103	10"	1.5	1,725	\$918.69	\$734.95



WIRE WHEELS

Part #	Size	Arbor Hole	Sale	Club
SH14057	6"	1/2" to 5/8"	\$18.69	\$14.95
SH14058	6"	1/2"	\$26.19	\$20.95
SH14059	8"	5/8"	\$40.63	\$32.50

GRINDING WHEELS

ALUMINUM OXIDE

Part #	Size	Grit	Face Width	Sale	Club
SH12771	6"	36	3/4"	\$23.13	\$18.50
SH2017	6"	46	3/4"	\$22.44	\$17.95
SH12772	6"	60	3/4"	\$23.13	\$18.50
SH12773	6"	80	3/4"	\$23.13	\$18.50
SH12778	7"	60	1"	\$24.94	\$19.95
SH12780	8"	36	1"	\$36.19	\$28.95
SH12781	8"	60	1"	\$36.19	\$28.95

SPARK-DUTY FORGED HI-VIS C-CLAMPS

OSHA SAFETY COLOR FOR PHYSICAL HAZARDS

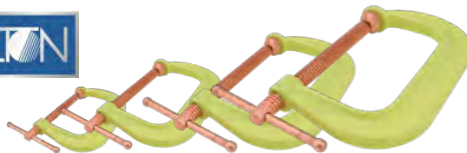

Part #	Size	Sale	Club
WLT20483	4"	\$99.94	\$79.95
WLT20484	6"	\$95.31	\$76.25
WLT20485	8"	\$122.44	\$97.95
WLT20486	10"	\$172.19	\$137.75

Drop forged, regular duty with extra deep throat. Copper plated spindle and Perma-pad® for resistance to welding spatter and corrosion, and are replaceable. Exceptional value high-visibility welding clamps. Lifetime Warranty.

BASH SLEDGE



Part #	Head	Length	Sale	Club
WLT20212	2.5lbs	12"	\$78.13	\$62.50
WLT20412	4lbs	12"	\$92.81	\$74.25
WLT20416	4lbs	16"	\$99.94	\$79.95
WLT20630	6lbs	30"	\$145.63	\$116.50
WLT20816	8lbs	16"	\$148.13	\$118.50
WLT20830	8lbs	30"	\$169.38	\$135.50
WLT20836	8lbs	36"	\$178.69	\$142.95
WLT21036	10lbs	36"	\$205.94	\$164.75
WLT22036	20lbs	36"	\$344.38	\$275.50

BASH BRASS SLEDGE



****BRASS HEADS ARE NON-SPARKING****

Part #	Head	Length	Sale	Club
WLT90212	2.5lbs	12"	\$153.69	\$122.95
WLT90412	4lbs	12"	\$198.69	\$158.95
WLT90416	4lbs	16"	\$221.19	\$176.95
WLT90616	6lb	16"	\$304.06	\$243.25

BASH CROSS PEIN



Part #	Head	Length	Sale	Club
WLT30216	2lbs	16"	\$74.94	\$59.95

BASH DEAD BLOW



Part #	Head	Length	Sale	Club
WLT55314	2.5lbs	12"	\$82.44	\$65.95
WLT55416	4lbs	16"	\$114.38	\$91.50
WLT55830	6lbs	30"	\$164.69	\$131.75

BASH BALL PEIN



Part #	Head	Length	Sale	Club
WLT32414	24oz	14"	\$66.19	\$52.95
WLT33214	32oz	14"	\$74.94	\$59.95
WLT34014	40oz	14"	\$83.69	\$66.95



WLT11111
3pc B.A.S.H Mechanic's Hammer Set
 Includes: 4lb x 12" Sledge, 32oz x 14" Ball Pein, & 2lb x 16" Cross Pein.
 Sale \$193.44 **Tool Club \$154.75**

WLT11113
3pc B.A.S.H. Dead Blow Hammer Kit
 Includes:
 2lb x 14",
 3lb x 14" & 4lb x 16".
 Sale \$229.38 **Tool Club \$183.50**

TIT63125 **TITAN**
5pc Hammer Set
 Ball Pein, Rubber Mallet, Sledge, & Cross Pein
 Sale \$78.13
Tool Club \$62.50

WILM7134
5pc Fiberglass Handle Ball Pein Set
 Sizes: 8, 12, 16, 24 & 32oz.
 Sale \$73.44
Tool Club \$58.75



WILM7040B
2pc Hammer Set
 3lb Cross Pein & Sledge
 Sale \$33.69 **Tool Club \$26.95**



DEAD BLOW **P Performance Tool**

HI-VISIBILITY COLOR

Part #	Size	Sale	Club
WILM7216	16oz.	\$14.38	\$11.50
WILM7224	24oz.	\$17.81	\$14.25
WILM7232	32oz.	\$20.94	\$16.75
WILM7248	48oz.	\$21.88	\$17.50
WILM7264	64oz.	\$24.69	\$19.75

TIT63133
3pc Dead Blow Set
 Sizes: 12oz, 1lb & 1-1/2lb. Shock absorbing steel shot filled canister for maximum force with reduced rebound
 Sale \$45.63 **Tool Club \$36.50**



GW GEARWRENCH
KDT82303D **NEW!**
5 Pc. Hammer and Mallet Set
 Sale \$137.44
Tool Club \$109.95



TIT85070
5pc Hickory Wood Handle Hammer Set
 Includes 3lb sledge hammer, cross pein hammer, 32oz & 16oz ball pein hammers and 32oz rubber mallet. Wooden handles are lightweight & easy to replace if damaged, and are natural shock-absorbers.
 Sale \$62.44 **Tool Club \$49.95**



SLEDGE **P Performance Tool**

ALL HAVE FIBERGLASS HANDLE

Part #	Size	Sale	Club
WILM7100	3 lb	\$18.69	\$14.95
WILM7101	4 lb	\$23.44	\$18.75
WILM7114	10 lb	\$46.88	\$37.50

TIT63216
2lb. Brass Hammer
 Sale \$53.69
Tool Club \$42.95



TIT63040
3lb. Brass Hammer
 Sale \$82.81
Tool Club \$66.25



WILM7132
32oz. Rubber Mallet
 Sale \$10.94
Tool Club \$8.75



WILM7019B
8oz Stubby Claw Hammer
 Sale \$9.38
Tool Club \$7.50



WLT31036
B.A.S.H. 36" 10lb Spike Maul
 Hi-Vis, drop forged 46 HRC steel head endures the most demanding applications. Safety plate secures head to handle. Thick, tapered neck absorbs vibration. Vulcanized rubber handle for secure grip while striking.
 Sale \$304.69 **Tool Club \$243.75**



**KDT82306
27pc Punch & Chisel Set**

Includes:
6 pin,
6 starter,
3 center,
4 long taper,
8 cold chisels
& tool roll.
Sale \$233.69
Tool Club \$186.⁹⁵



**MAY61050
24pc Punch & Chisel Set**

Includes: 6 cold chisels, 1 cape chisel,
1 half round chisel, 1 diamond point chisel,
6 solid punches, 6 pin punches, 1 prick punch,
2 center punches & tool roll.
Sale \$185.63 **Tool Club \$148.⁵⁰**



**MAY61019
19pc Punch & Chisel Set**

Includes: 2 center, 6 pin punches, 6 solid punches, 5 cold chisels & tool roll.
Sale \$137.44 **Tool Club \$109.⁹⁵**

**KDT82305
12pc Punch & Chisel Set**

Includes
4 cold chisels,
4 pin punches,
4 taper punches.
& tool roll.
Sale \$86.56
Tool Club \$69.²⁵



**MAY62254
12pc Pilot Punch**

Sizes: 1/16" - 1/2"
Sale \$131.19
Tool Club \$104.⁹⁵



**MAY62250
6pc Pilot Punch Set**

Sizes: 1/8", 5/32",
3/16", 7/32",
1/4", & 5/16".
Sale \$66.25
Tool Club \$53.⁰⁰

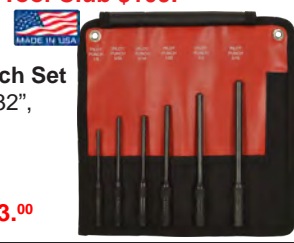

**KDT82307
4pc Long Taper Punch Set**

Sale \$49.38
Tool Club \$39.⁵⁰



**MAY61005
6pc Punch & Chisel Set**

Includes: 1 center, 2 pin,
1 solid, 2 cold chisels
Sale \$48.75
Tool Club \$39.⁰⁰



HD INDIVIDUAL CHISELS



Part #	Size	Sale	Club
MAY10206	1/2 x 9"	\$11.88	\$9.⁵⁰
MAY10212	3/4 x 7"	\$12.19	\$9.⁷⁵
MAY10213	3/4 x 12"	\$16.88	\$13.⁵⁰
MAY10216	7/8 x 7.5"	\$16.88	\$13.⁵⁰
MAY10219	7/8 x 18"	\$30.63	\$24.⁵⁰
MAY10220	1 x 8"	\$21.88	\$17.⁵⁰

**KDT82309
5pc Pin Punch Set**

Sale \$41.88
Tool Club \$33.⁵⁰



**MAY61044
14pc Punch & Chisel Kit**

Includes: 5 cold chisels,
2 solid punch, 5 pin punch,
1 punch aligner
and 1 center punch
Sale \$109.94
Tool Club \$87.⁹⁵



**KDT82304
5pc Punch & Chisel Set**

Sale \$33.69
Tool Club \$26.⁹⁵



BRASS PUNCHES

**MAY61365
3pc XL Brass Punch Set**

Includes: 3/4 x 12" drift punch,
3/8" & 7/16" line up punches.
Sale \$178.69
Tool Club \$142.⁹⁵

EXTRA LONG



**MAY67003
5pc Brass Drift Punch Set**

Includes: 1/4 x 4,
3/8 x 6, 1/2 x 7, 5/8 x 8
3/4 x 8 Drift Punches
Sale \$81.88
Tool Club \$65.⁵⁰



**KDT82308
4pc Cold Chisel Set**

Sale \$49.38
Tool Club \$39.⁵⁰



**MAY62278
4pc Brass Punch Set**

Includes: 1/4" solid, 3/8" drift,
3/16" & 5/16" pin punches.
Sale \$41.88
Tool Club \$33.⁵⁰



**MAY67001
3pc Brass Scraper Set**

Includes: 3/8 x 5-1/2", 1/2 x 6"
and 5/8 x 6-1/2" Scrapers
Sale \$57.81
Tool Club \$46.²⁵



**LIS30280
Automatic Centerpunch**

Fires when downward pressure is applied.
Sale \$23.69 **Tool Club \$18.⁹⁵**



**MAY62277
4pc Brass Punch Set**

Includes: 3/8" drift, 1/4" & 3/8" pin and
1/4" brass solid punch.
Sale \$49.38
Tool Club \$39.⁵⁰



**MAY67004
3pc Brass Punch Set**

Includes: 1/4, 3/8
and 1/2" Pin Punches
Sale \$41.88
Tool Club \$33.⁵⁰



**MAY89021
3pc Hammerless Set**

Includes Prick
Punch/Center
Punch combo, Pin
Punch/Hammer Combo &
Cold Chisel/Hammer
Combo.
Sale \$37.44
Tool Club \$29.⁹⁵



**MAY61360
3pc Brass Drift Punch Set**

For non-sparking
applications critical in
hazardous conditions.
Sale \$60.63
Tool Club \$48.⁵⁰



NEW!



**MAY67012
12pc Brass Punch & Scraper Set**

Includes: 2 scrapers,
3 drift punches, 7 pin punches & tool roll.
Sale \$116.56 **Tool Club \$93.²⁵**





PRY BARS FEATURE A STEEL SHAFT THROUGH THE ENTIRE HANDLE



MAY14068
3pc Dominator® Long and Heavy Duty Pry Bar Set with Rack
 Sizes: 7/8" SQ x 44", 3/4" SQ x 48", 3/4" SQ x 58"
 Sale \$343.69 **Tool Club \$274.95**

MAY61366
5pc Dominator Curved Pry Bar Set
 Strike-able end caps.
 Sizes: 10", 12", 17", 25", & 31" long.
 Sale \$149.38
Tool Club \$119.50



MAY61355
3pc Curved Head Set
 Sizes: 7", 12" & 18" long.
 Sale \$96.19 **Tool Club \$76.95**



MAY14071BL
3pc Blue Curved Pry Bar Set
 Sizes: 12", 17" & 25" long.
 Sale \$104.38 **Tool Club \$83.50**



MAY31091
3pc Dominator® Economy Curved Pry Bar Set
 Sizes: 13", 17" & 24"
 Sale \$56.88 **Tool Club \$45.50** **NEW!**



MAY14074
3pc HD Pry Bar Set
 Dominator pry bars. Includes: 36" & 24" Curved, & 18" Straight pry bars.
 Sale \$173.13 **Tool Club \$138.50**



MAY14065
4pc Dominator® Curved Pry Bar Set
 Sizes: 8", 12", 25" & 36" long.
 Sale \$174.38 **Tool Club \$139.50**



MAY14064
4pc Dominator® Straight Pry Bar Set
 Sizes: 8", 12", 25" & 36"
 Sale \$169.94 **Tool Club \$135.95**



MAY60150
3pc Pro LadyFoot Bar Set
 Sizes: 1/2" x 12"; 5/8" x 16"; & 3/4" x 21
 Sale \$116.88 **Tool Club \$93.50**



KDT82301D
3pc Indexing Pry Bar Set
 Sizes: 8", 10" & 16"
 Sale \$174.94 **Tool Club \$139.95**



KDT82233
33" Indexing Pry Bar
 Head rotates 180° w/ 14 locking positions
 Sale \$124.94 **Tool Club \$99.95**

INDIVIDUAL DOMINATOR



Part #	Length	Head	Sale	Club
MAY14116	31"	5/8" H.D. Curved	\$59.94	\$47.95
MAY14120	58"	5/8" H.D. Curved	\$137.44	\$109.95
MAY14107	36"	Straight	\$80.63	\$64.50
MAY14108	42"	Straight	\$86.19	\$68.95
MAY14117	36"	Curved	\$87.44	\$69.95
MAY14118	42"	Curved	\$88.13	\$70.50
MAY14119	48"	Curved	\$127.19	\$101.75
MAY14123	44"	Curved	\$162.44	\$129.95



LANG853-5ST
5pc Curved Pry Bar Set
 Sizes: 12", 17", 25", 31" & 36".
 Tips are bent for ease of access.
 Sale \$118.13 **Tool Club \$94.50**

ANGLED BLADE

Part #	Length	Sale	Club
SUN9812	12"	\$19.38	\$15.50
SUN9817	17"	\$22.19	\$17.75
SUN9825	25"	\$36.56	\$29.25
SUN9833	31"	\$41.88	\$33.50
SUN9837	37"	\$59.69	\$47.75
SUN9803	3pc 12", 17", 25"	\$70.63	\$56.50



KDT82821H
6PC 4" Mini File Set
 Set includes Flat, Half Round, Round, Knife, Square & Triangle Files.
 Includes pouch for storage & organization.
 Sale \$53.13 **Tool Club \$42.50**



KDT82820H
4PC 8" File Set
 Includes Flat, Round, Half Round & Triangle Files. Includes storage tray.
 Sale \$91.19 **Tool Club \$72.95**



IPA8108
8" Diamond File Set
 Includes Half Round, Round, Flat & Square diamond coated files.
 Cuts into welds & hardened surfaces where other files can't. Cuts 10x Faster & in all directions!
 Sale \$103.13 **Tool Club \$82.50**



MOUNT/DEMOUNT SPOONS



Part #	Length / Application	Sale	Club
KEN32117	16" (Pair) - Cycle / ATV	\$49.94	\$39.95
KEN32119	24" Straight - Car / Cycle / ATV	\$42.44	\$33.95
KEN33220	30" Curved - Truck / Tractor	\$49.94	\$39.95
KEN34747	36" Straight - Truck / Tractor	\$87.44	\$69.95
KEN34645	37" Rounded - Car / Truck / Tractor	\$87.44	\$69.95
KEN34645C	37" Tubeless - Car / Truck / Tractor	\$101.88	\$81.50
KEN34647	41" H.D. - Truck / Tractor	\$112.44	\$89.95

KEN35442

Truck Tire Service Set

Includes Blue Cobra dismount tool, tubeless tire iron, double-end tire spoon, 8 lb. bucket of Euro Paste Lube/Anti-rust, style lube applicator brush, aluminum C-Lok bead holder, and leather rim protector. Sale \$599.94 **Tool Club \$479.95**



KEN35440

Blue Cobra Truck Tire Dismount Tool

Sale \$449.94 **Tool Club \$359.95**



KEN34950

IRONMAN Ergonomic Wheel Lifting Bar

Lift all sizes and types of small, large, heavy & awkward truck tires & wheel assemblies.

Sale \$106.19 **Tool Club \$84.95**



LIS21520

Truck Brake Pedal Depressor

Extends from 18-1/2" to 34-1/2"

Sale \$57.81 **Tool Club \$46.25**



Ken-Tool TIRE CAGES

Stay Safe While Inflating Tires Of Any Size!



Many More Sizes Available!

Part #	Description	Sale	Club
KEN36010	Super Magnum 5 Bar	\$1,749.94	\$1,399.95
KEN36007	Portable 2 Bar - 43.5" x 20.5"	\$524.94	\$419.95
KEN36001	Portable 2 Bar - 41" x 16"	\$524.94	\$419.95
KEN36002	4 Bar - 43.5 x 20.5"	\$874.94	\$699.95

WLT51136

11lb Head, 36" B.A.S.H.® Bead Breaking Wedge

Unbreakable® Handle Technology. Steel core eliminates breaking during overstrikes.

Sale \$218.13 **Tool Club \$174.50**



KEN35429

32" Duck-Billed Bead Breaking Wedge with Fiberglass Handle

Breaks beads quickly & easily. Handle serves as a lever.

Sale \$158.69 **Tool Club \$126.95**



AFF3591

Super Single Wheel Dolly

For large truck tires. 26" W carriage.

Tire diam: 36" to 48".

450lb. Capacity.

Sale \$187.44 **Tool Club \$149.95**



KEN34549

Dual Wheel Separator

For use on nearly any truck, bus, van, or trail that has dual steel wheels.

Sale \$287.44 **Tool Club \$229.95**



OTC5105B

1,100lb Capacity High-Lift Dual Wheel Dolly

Effortless air-powered hydraulic lift system for a variety of applications.

0 to 42" lifting range.

Six-inch lateral adjustment.

Tilt adjustment of +15° to -8° ensures easy alignment.

Features four swivel casters, two locking, for enhanced mobility.

Sale \$5,243.75 **Tool Club \$4,195.00**



OTC1769A

Truck Dual Wheel Dolly

Swivel casters, 3-1/2" front and 3" rear, provide easy maneuverability. Floor space is 43" by 42".

Hydraulic jack provides over 6-1/2" of lift and tilts wheel assembly 7° to prevent damage to wheel seal.

Includes a 6' support chain.

Sale \$787.44 **Tool Club \$629.95**



THA68015

Hydraulic Wheel Dolly

1,500lb Capacity

Min Height 3.38 max lift 11.25"

Smooth operation for the removal and installation of single,

tandem and duplex tires and wheels

Sale \$624.94 **Tool Club \$499.95**



AST7449

20" Tire Iron Spoon Lever

Specially designed tip engages with the bead for easy removal.

Sale \$24.94 **Tool Club \$19.95**

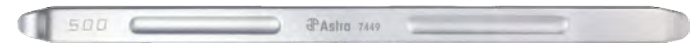

CAP NUT WRENCHES

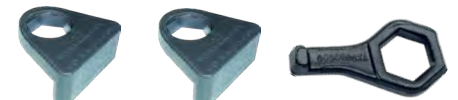

Part #	Style	Size	Sale	Club
KEN30618	SAE	1-1/2"	\$69.69	\$55.75
KEN30619	METRIC	41mm	\$66.88	\$53.50
KEN30612	METRIC	41mm	\$31.19	\$24.95

BEAD SEATERS



KEN31444 Mega AirBlast Bead Seater

For tires up to 24.5" in diameter. 5 gallon tank. Air pressure gauge and safety release valve included. Plastic nose clip protects wheels.

Sale \$287.44 **Tool Club \$229.95**



KEN31445 Mega AirBlast™ Bead Seater Aluminum Tank

For tires up to 24.5" in diameter. 5 gallon tank. Used on Auto, ATV and Truck Tires.

Sale \$312.44 **Tool Club \$249.95**



OTC4240A

King Pin Pusher

Hydraulically removes and installs king pins, straight & tapered. Range: 7/8" - 2". Includes hydraulic pump. 30 ton capacity. Works on both straight and tapered kingpins. Works on a variety of trucks & buses. Sale \$3,249.94 **Tool Club \$2,599.⁹⁵**

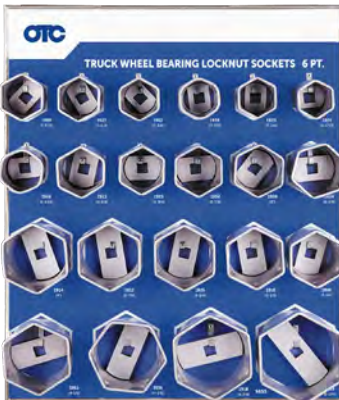

OTC9850

21pc 6PT Wheel Bearing Locknut Sockets with Tool Board

Sizes: 2-3/32" - 5-1/4"
Sale \$1,037.44 **Tool Club \$829.⁹⁵**

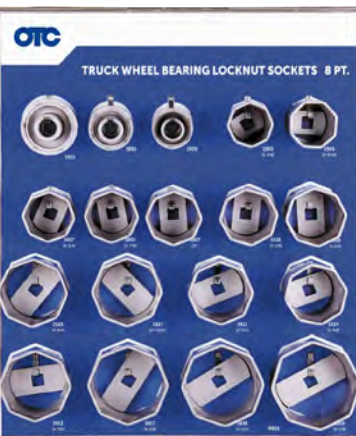

OTC5668

Universal Cylinder Liner Puller

Designed to be used with an impact wrench for quick cylinder liner removal. Spring loaded puller arms automatically adjust to fit the liner. Ranges from 3-7/8" - 6-1/4" bore diameters, sleeve depths of 15", & liner wall thickness of 0.273" minimum. Sale \$662.44 **Tool Club \$529.⁹⁵**



CTA5044

MACK Truck King Pin Socket

Fits most MACK front axles (12,000 to 20,000 lbs.) Sale \$51.56 **Tool Club \$41.²⁵**



CTA5048

Engine Barring Socket MX13 Engine

Applications: MACK E7 & CAT 3208 Sale \$55.63 **Tool Club \$44.⁵⁰**



CTA5073

Cummins Engine Barring Tool - 5.9L

Dodge Pickups with the 3.9L, 5.9L, 6.7L & 8.3L diesels engines and Cummins B/C Series diesels engines. Sale \$72.44 **Tool Club \$57.⁹⁵**



LIS49000

Truck Brake Cage Bolt Socket - 3/4"

Extra deep 3/4" socket loosens cage bolt to unlock air brakes on trucks. Sale \$24.06 **Tool Club \$19.²⁵**



LIS49020

Truck Cage Bolt Socket - 15/16"

Extra deep socket. Can be used with an impact wrench. Sale \$29.38 **Tool Club \$23.⁵⁰**



LIS49040

Truck Brake Cage Bolt Socket - 1-1/16"

Extra deep 1-1/16" socket loosens cage bolt to unlock air brakes on trucks. Sale \$29.94 **Tool Club \$23.⁹⁵**



LANG2577

8pc Floating Axle Housing Thread Restorer Kit

7 thread restorer dies and one driver socket for use with 1/2" ratchet. Sale \$212.44 **Tool Club \$169.⁹⁵**



LOCK NUT SOCKETS



AFF #	Desc. (PT)	Club	AFF #	Desc. (PT)	Club
18501	2-3/32" (6)	\$33. ⁵⁰	18521	2-1/2" (6)	\$33. ²⁵
18503	2-3/8" (8)	\$32. ⁹⁵	18522	2-5/8" (6)	\$33. ²⁵
18505	2-9/16" (8)	\$35. ⁹⁵	18523	2-3/4" (6)	\$34. ⁹⁵
18506	3" (6)	\$39. ²⁵	18524	3-3/8" (8)	\$39. ⁹⁵
18507	3" (8pt.)	\$38. ⁷⁵	18525	3-3/4" (8)	\$41. ²⁵
18508	3-1/4" (6)	\$36. ⁹⁵	18526	3-3/4" (6)	\$42. ⁵⁰
18509	3-1/4" (8)	\$34. ⁵⁰	18527	3-13/16" (8)	\$41. ⁵⁰
18510	3-1/2" (6)	\$36. ⁹⁵	18528	2-9/16" (6R)	\$33. ⁵⁰
18511	3-1/2" (8)	\$40. ²⁵	18532	2-7/8" (6)	\$34. ⁹⁵
18512	3-7/8" (6)	\$42. ⁵⁰	18533	2-7/8" (8)	\$38. ²⁵
18513	3-7/8" (8)	\$41. ⁹⁵	18534	3-1/8" (6)	\$41. ⁵⁰
18514	4" (6)	\$39. ⁹⁵	18535	3-1/8" (8)	\$39. ⁹⁵
18515	4-1/8" (6)	\$39. ⁵⁰	18536	2-3/8" (6R)	\$38. ⁵⁰
18516	4-3/8" (6)	\$59. ⁹⁵	18537	2-3/4" (8)	\$35. ⁹⁵
18517	4-3/8" (8)	\$53. ⁵⁰	18538	4-1/2" (8)	\$59. ⁹⁵
18518	4-7/8" (6)	\$62. ⁵⁰	18539	5-1/4" (6)	\$64. ⁹⁵
18519	4-7/8" (8p)	\$62. ⁵⁰	18540	4-1/8" (8)	\$55. ⁹⁵
18520	2-1/4" (6)	\$39. ⁹⁵	18541	4-13/16" (8)	\$69. ⁹⁵

CTA8229

Ford Crankshaft Rear Seal Installer

2003-2010 Ford 4.5L, 6.0L & 6.4L Power Stroke Sale \$262.44 **Tool Club \$209.⁹⁵**



CTA5415

HD Loose Lug Nut Indicator Removal

Easily removes stubborn lug nut Indicators from heavy duty fleet vehicle. Sale \$78.13 **Tool Club \$62.⁵⁰**



CAL199

Heavy Duty U-Joint Puller

Used to remove the HD vehicle driveline u-joints on class 7 & 8 trucks using an impact wrench up to 1". Disassemble & reassemble u-joint cups without heat or hammering. Sale \$176.88 **Tool Club \$141.⁵⁰**



DIESEL FILTER WRENCHES FOR DAVCO

Special design for removing and replacing main filter collar and vent cover on aftermarket diesel fuel filter systems.



Part #	Size	Sale	Club
LIS61090	5"	\$30.31	\$24. ²⁵
LIS61110	6"	\$35.31	\$28. ²⁵
LIS61130	8"	\$39.38	\$31. ⁵⁰

LIS61140

Diesel Filter Wrench For Ford Transit

For 2015 to current 150, 250, & 350 models. Sale \$34.06 **Tool Club \$27.²⁵**



WIPES

TUB O' TOWELS



TUB-TX90
Tub O' Towels All Purpose Wipes
 90 count tub. 10" x 12" cleaning surface.
 Perfect for all your cleanup needs at home and in the shop. Tough cleaning solution.
 Sale \$21.19 **Tool Club \$16.95**

TUB-TW40-GR
Granite, Tile, and Marble Cleaning Wipes
 40 Count Wipes. Safe for stone surfaces, marble, granite, quartz, travertine, limestone, onyx, Corian, Formica, Silestone, laminate, porcelain, tile, ceramic, fiberglass and any non-porous hard surface countertop.
 Large, 7-inch by 7-inch
 Sale \$13.69
Tool Club \$10.95



TUB O' TOWELS

TUB-TW40-CP
Carpet & Upholstery Cleaning Wipes
 40 Count Wipes. Remove tough stains through a blend of cleaners specifically engineered to clean carpet and upholstery. Large, 7-inch by 8-inch.
 Sale \$13.69
Tool Club \$10.95



TUB O' TOWELS

TUB-TW40-SS
Heavy Duty Stainless Steel Wipes
 40 Count Wipes. Remove tough stains. Cleaning stainless steel appliances or surfaces.
 Large, 7-inch by 8-inch.
 Sale \$13.69
Tool Club \$10.95



TUB O' TOWELS

TUB-TW40-CHR
Heavy Duty Chrome Wipes
 40 Count Wipes. Remove tough stains. Cleaning stainless steel appliances or surfaces.
 Large, 7-inch by 8-inch.
 Sale \$13.69
Tool Club \$10.95



HAND CLEANER

TUB-TS28 **NEW!**
Pumice-Free Hand Cleaner
 1 Gallon (128oz) Removes Tough Grime, Without Water. Hand cleaner features a pumice-free biodegradable walnut shell formula that is great for cleaning hard working hands and does not clog drains.
 Sale \$37.44 **Tool Club \$29.95**



TUB-TS64 **NEW!**
Pumice-Free Hand Cleaner
 1/2 Gallon (64oz) Removes Tough Grime, Without Water. Hand cleaner features a pumice-free biodegradable walnut shell formula that is great for cleaning hard working hands & does not clog drains.
 Sale \$26.19 **Tool Club \$20.95**



LUBRICANT

TUB-LA01 **NEW!**
Deep Lubricating Oil
 1.5 Oz Aerosol Can Contains Molybdenum disulphide for superior lubricating performance!
 Sale \$8.69 **Tool Club \$6.95**



TUB-LA12 **NEW!**
Deep Lubricating Oil
 11 Oz Aerosol Can Contains Molybdenum disulphide for superior lubricating performance!
 Sale \$13.69 **Tool Club \$10.95**



TUB-RE01 **NEW!**
Free All Deep Penetrating Oil
 1.5 Oz Aerosol Can Penetrates rust, scale & corrosion to free parts and assemblies instantly.
 Sale \$8.69 **Tool Club \$6.95**



TUB-RE12-RS **NEW!**
Free All Deep Penetrating Oil
 11 Oz Aerosol Can Penetrates rust, scale & corrosion to free parts and assemblies instantly.
 Sale \$20.63 **Tool Club \$16.50**



FOR20857 **NEW!**
Cutting Fluid
 4oz Cutting Fluid Use for tapping, threading, drilling and reaming.
 Sale \$13.69 **Tool Club \$10.95**



SAFETY

sellstrom.

SURS96110
KneePro Ultra Flex III Knee Pads
 Articulating hinged design. Replaceable grip strips. Virtually indestructible. Quick-snap clips for easy removal.
 Sale \$43.13 **Tool Club \$34.50**



JAC14230
QUAD 500™ Premium Multi-Purpose Face Shield
 Extra-large window provides superior panoramic view. Premium STA-Clear anti-fog coating. Integrated side & chin guard. Shade 5 flip-up visor.
 Sale \$99.94
Tool Club \$79.95



SURS32151 **NEW!**
Multi-Purpose Face Shield w/ Flip-Up IR Window & Ratcheting Headgear
 Includes stylish crown, full 9" x 12-1/8" x 0.060" molded polycarbonate AF window, 4-3/8" x 9-1/4" x 0.070" flip-up/flip-down IR visor and premium ratcheting headgear suspension.
 Sale \$82.44 **Tool Club \$65.95**



JAC50000
Safety Glasses w/ Black Frame & Clear Lens
 Sale \$8.13 **Tool Club \$6.50**



JAC50002
Safety Glasses w/ Black Frame & Clear Lens
 Sale \$8.13 **Tool Club \$6.50**



JAC50006
Safety Glasses w/ Black Frame & Clear Lens
 Sale \$8.13 **Tool Club \$6.50**



KIM75260 **NEW!**
Rags in a Box
 Ideal for painting, wiping up spills, staining, and refinishing furniture
 Sale \$23.69 **Tool Club \$18.95**



MMM8880 **NEW!**
BRAKE CLEANER
 14oz High-pressure flushing action cleans braking systems with ease
 Sale \$11.19 **Tool Club \$8.95**





BALL JOINT

OTC6530 Master Ball Joint Press

Includes: All adapters for pressed on ball joints, including ones needed for 4WD, SUV's and light trucks.
Sale \$587.44 **Tool Club \$469.95**



OTC7249 Ball Joint Press

Removes and installs ball joints, universal joints, and truck brake anchor pins.
Sale \$212.44
Tool Club \$169.95



OTC6736 Large C-Frame

Required for use with Sprinter Van Ball Joint Kit Large C-Frame & forcing screw assembly
Sale \$187.44
Tool Club \$149.95



AST7865 Ball Joint Press

Removes and installs ball joints, universal joints and truck brake anchor pins.
Sale \$106.19
Tool Club \$84.95



AST7868 Ball Joint Adapters

Allows a ball joint press to work on most 4WD's & light trucks.
Sale \$99.06
Tool Club \$79.25



AST78100 Goliath Ball Joint XL C-Frame Press

Includes both long and short drive screws to maintain a shorter overall working length when desired.
Sale \$106.19 **Tool Club \$84.95**



NEW!

CTA7395 Ball Joint Hammer Nut Kit

Separates the steering knuckle & suspension joints from control arms and strut assemblies using an impact hammer.
Sale \$37.44 **Tool Club \$29.95**



NEW!

AST78197 Goliath Master Ball Joint Set

Large forged alloy C frame press Works on 2WD & 4WD Domestic, Import & Euro vehicles through the 2020's, includes information for over 1,100 applications.
Sale \$243.69 **Tool Club \$194.95**



Astro Pneumatic



OTC6539 55pc Ball Joint Service Kit (Trucks/Van/SUV)

Covers press in ball joints on the following Truck/Van/SUV applications: Toyota, Hyundai, KIA, Infinity, Isuzu, Nissan, Chrysler, Dodge, Jeep, Plymouth, Mitsubishi, Ford, Lincoln, Mercury, Mazda, Chevrolet, Buick, Oldsmobile, Pontiac, Cadillac, GMC, Hummer up to 2008.
Sale \$1,349.94
Tool Club \$1,079.95

AST7897 Master Ball Joint Press

Includes: Press plus all adapters. For all cars and light trucks.
Sale \$209.94
Tool Club \$167.95



AST78825 Master Front Wheel Drive Bearing Adapter Kit

Replace wheel bearings without the need for alignment after by keeping the strut assembly and steering knuckle in place.
Sale \$137.44
Tool Club \$109.95

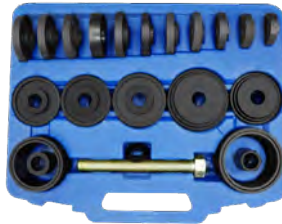

AST78912 Low Profile Ball Joint Separator

Designed for tight access where most ball joint separators won't fit. Particularly useful on 2005+ Ford, Lincoln & Mercury applications. Impact rated durable forge design.
Sale \$62.44 **Tool Club \$49.95**



Astro Pneumatic

AST78830 Heavy Duty Hub Drum & Rotor Puller Kit

Use with impact wrench to remove hubs, drums and brake rotors (discs). Durable forged design, made from same alloy used on Astro's famous ball joint presses. Use with 1-1/4" socket and 1-1/4" or 32mm wrench. Drum & Rotor pulling arms include raised stops for use with ratchet straps (not included) for especially difficult applications. Includes three different hub adapters to fit all types of hub sizes.
Sale \$174.94 **Tool Club \$139.95**

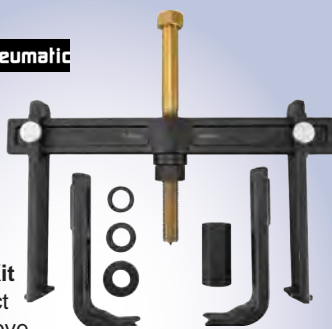

FRONT END



OTC6575 Hub Grappler™

Complete solution for servicing wheel hubs and bearings on the vehicle without removing the steering components or knuckle. Application coverage up to 2009 model year. Includes carrying case and application guide.
Sale \$862.44 **Tool Club \$689.95**



WILW89303 5pc Front-End Service Set

For removal of most types of pitman arms, tie rods and ball joints found on automotive and light truck applications.
Sale \$137.44 **Tool Club \$109.95**

CTA4305 Front Hub Puller

Sale \$67.81
Tool Club \$54.25



OTC7394 Hub Puller

Arms adjust to 7-1/2".
Sale \$199.94
Tool Club \$159.95



OTC6290A Front Hub Puller

For 4WD vehicles.
Sale \$249.94
Tool Club \$199.95



OTC7315A Tie Rod End Puller

Fits most front wheel drive cars.
Sale \$69.94
Tool Club \$55.95



LIS39250 Front Hub & Knuckle Separator

For 2003+ 4WD 3/4 & 1 ton Dodge. Use with air hammer.
Sale \$30.31
Tool Club \$24.25



LIS39300 Front Hub & Knuckle Separator

Use with air hammer.
Sale \$28.69
Tool Club \$22.95



FRONT END



MAY31940
5pc Pneumatic Separating Fork Set
 Handles ball joints with minimal shock to the assembly. .401 shank.
 11/16", 15/16", 1-11/16", 1-3/8", 1-1/8".
 Sale \$178.69 **Tool Club \$142.95**

LIS41440
5pc Stepped Pickle Fork Kit
 Sizes: 1-1/8", 11/16", 15/16", 1-5/8", 1-7/16".
 Handle & pneumatic driver.
 Sale \$131.19 **Tool Club \$104.95**

LIS41400
Stepped Pickle Fork Kit
 Includes 3 Forks.
 Sizes: 1-1/8", 11/16" & 15/16" Handle and pneumatic driver.
 Sale \$74.38 **Tool Club \$59.50**

LIS18520
Tie Rod Fork
 21/32" opening.
 Sale \$28.13 **Tool Club \$22.50**

LIS18530
Ball Joint Fork
 15/16" opening.
 Sale \$28.13 **Tool Club \$22.50**

TA61900
Ball Joint & Tie Rod Puller
 Separate tie rod ends & ball joints.
 Sale \$29.94 **Tool Club \$23.95**

CAL18510
Bolt Retained Bearing Cup Installer
 Quickly & easily installs bearing cups on bolt retained universal joints. Fits series 1610 to 1880 and nearly all heavy-duty truck & machine U-Joints with bolt retained bearing cups.
 Sale \$40.63 **Tool Club \$32.50**

TA61800
Strut Alignment Gauge
 Sale \$44.69
Tool Club \$35.75

CTA4040
GM Torsion Bar Tool
 For 88 - 10 GM.
 Sale \$112.44
Tool Club \$89.95

CTA4045
GM Torsion Bar Tool - Large
 For 2011 & up HD C/K GM trucks.
 Sale \$99.94
Tool Club \$79.95

PITMAN ARM

LIS41900
Pitman Arm Puller
 Sale \$38.13
Tool Club \$30.50

KDT2289D
Pitman Arm Puller **GEARWRENCH**
 Sale \$45.63
Tool Club \$36.50

OTC8150
HD Conical Pitman Arm Puller
 Works on most cars and light trucks.
 Sale \$87.44
Tool Club \$69.95

OTC7310A
Pitman Arm Puller
 Arms adjust to 2-1/4".
 Fits medium and heavy trucks.
 Sale \$121.88
Tool Club \$97.50

CAL18620
Sheppard M100 Pitman Arm Puller
 Easily remove uncooperative pitman arms on Sheppard M100 gear boxes. Can be used with up to a 3/4" impact tool.
 Sale \$96.19 **Tool Club \$76.95**

CAL18630
Sheppard M110 Pitman Arm Puller
 Easily remove uncooperative pitman arms on Sheppard M110 gear boxes. Can be used with up to a 3/4" impact tool.
 Sale \$168.69 **Tool Club \$134.95**

CAL18640
Intermediate Pitman Arm Puller
 Easily removes stubborn pitman arms on intermediate vehicles. May be used with up to a 1/2" impact tool.
 Sale \$141.88 **Tool Club \$113.50**

CTA4017
Axle Popper Set
 Separates half-shafts from transaxle. Shim tool to fill gaps. 14" long with 2" openings.
 Sale \$66.88 **Tool Club \$53.50**

CTA8200
Strut Lifter
 Removing & Installing Struts, Drive Shaft, Ball Joint.
 3 jaw sizes Articulated clamp for proper alignment with strut. Mount on 30mm hydraulic Transmission Jack.
 Sale \$562.44
Tool Club \$449.95

MCPHERSON STRUT

BRA7600
Strut Compressor
 This features a floating compression head for angled springs. Lower compression hooks easily fit between tight springs. New, updated design.
 Sale \$1,349.94
Tool Club \$1,079.95



Branick



OTC6494
Strut Compressor
 Range from 4" to 9". Can be used with an impact gun.
 Sale \$374.94
Tool Club \$299.95



LIS62300
Strut Compressor
 Extra narrow design will fit on many imports where others will not.
 Sale \$88.44
Tool Club \$70.75



TA62900
Strut Compressor
 This is the most popular compressor made. Handles springs up to 6".
 Sale \$87.44
Tool Club \$69.95



CTA4030
Internal Coil Spring Compressor
 Removes, installs & compresses coil springs. For coil springs that can't be reached from the center.
 Sale \$68.75
Tool Club \$55.00



Compressor with a Strut Assembly



CAL91300
Floor Mounted 2,200lb Strut Compressor
 Can be used with varying sizes of struts with coils up to 5/8" diameter. Ideal for passenger vehicles and light-trucks. Designed for easy, one-person use
 Sale \$449.94
Tool Club \$359.95



PULLERS / FRONT END

BMW CAMSHAFT



CTA7643
BMW Crankshaft Front and Rear Seal Removal & Installer Kit
 Services N40, N42, N45, N45T, N46, N46T, N52, N52K, N53, N54 & N55.
 Sale \$487.44 **Tool Club \$389.95**

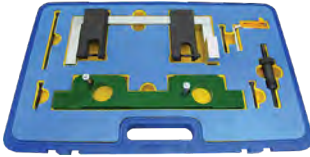

CTA7675
BMW Timing Tool Kit - N20/N26
 Aligns camshaft timing at TDC position on N20/N26 engines.
 Sale \$449.94 **Tool Club \$359.95**



CTA2888
BMW Timing Tool Kit
 Properly aligns and locks camshaft in TDC position for N62, N62TU, & N73 engines. Includes complete set of tools including hold-down tool & crankshaft timing pin.
 Sale \$406.19 **Tool Club \$324.95**



CTA2893
BMW Timing Tool Kit - N63
 Includes TDC pin. Services all N63 V8 including '09 & up 750i, '11 & up Alpina B7, '10 & up 550i, & '12 & up 650i.
 Sale \$305.94 **Tool Club \$244.75**

SUBARU



CTA2243
Camshaft Pulley Holder - Subaru
 For 2002-05 Subaru Impreza 2.0 Turbo & 2000 Subaru Forester L F4-2.5L SOHC. Will not fit 2005 2.0 Turbos with variable cam timing.
 Sale \$61.19 **Tool Club \$48.95**



CTA7615
Subaru Camshaft Holder
 Holds camshaft sprockets on 2005 & up Subaru models w/ 2.5L Turbo & 3.6L engines.
 Sale \$68.69 **Tool Club \$54.95**



CTA7625
Subaru Crankshaft Pulley Holder
 3-Point design to hold the AVICS intake camshaft.
 Sale \$51.88 **Tool Club \$41.50**



CTA5305
Subaru Crank Socket
 FA & FB Series Engines
 Works with 1/2" ratchet or breaker bar.
 Sale \$37.44 **Tool Club \$29.95**



CTA7630
Subaru Crank Socket
 EJ Series Engines
 Works with 1/2" ratchet or breaker bar.
 Sale \$37.44 **Tool Club \$29.95**



CTA7996
BMW Timing Tool Kit - N51-N55
 Applications: 2006+ BMW models 3.0L Non-Turbo & 3.0L Twin Turbo Engine
 Sale \$737.44 **Tool Club \$589.95**



CTA2022
Crankshaft Service Tool Set
 Services B38 (1.2L & 1.5L) & B48 (2.0L) engines. 330e, 740e, i8, MINI Cooper, Countryman
 Sale \$75.63 **Tool Club \$60.50**



CTA2885
BMW 4 & 6 Cylinder Camshaft Alignment Tools
 Includes jig to align camshafts & TDC pin. Services BMW M42, M44, M50, M52, M52TU, M54, M56, S50US & S52US engines.
 Sale \$124.94 **Tool Club \$99.95**



CTA2805
BMW Timing Tool Kit B38/B48 - 1.5L & 2.0L
 Designed for locking the crankshaft and camshafts. For correctly setting the timing position while servicing.
 Sale \$469.06 **Tool Club \$375.25**



CTA2894
BMW Timing Tool Kit M60, M62
 Includes alignment fixtures, chain tensioner, chain tensioner locking springs, crankshaft pins, and VANOS tools. Services BMW from '92 - '03. Range Rover from '03 - '05.
 Sale \$499.94 **Tool Club \$399.95**

VOLVO



CTA2863
Volvo Cam/Crank Alignment Kit
 Services all 850, 960, S70, C70, C30, V50, S40, '01-'09 S60, '99-'06 S80, '98-'07 V70, '98-'07 XC70 & V70XC, '03-'06 XC90 w/5 cyl., '03-'06 XC90 w/6 cyl.
 Sale \$387.44 **Tool Club \$309.95**



CTA2864
Cam Locking Tool for Volvo
 Services Volvo 850, S40, S70 & S90. For alignment of the cam & crankshafts.
 Sale \$160.63 **Tool Club \$128.50**



CTA7635
Volvo/Ford Crankshaft Counter Holder
 Used to counter-hold the crankshaft pulley to release & tighten the center bolt.
 Sale \$68.69 **Tool Club \$54.95**

BENZ CAMSHAFT



CTA3768
Benz Camshaft Timing Tool Kit - M177 & M178
 2014+ Mercedes Benz AMG C63, E63, S63, GT and GT-S with biturbo 4.0L V8 engines M177 & M178
 Sale \$849.94 **Tool Club \$679.95**



CTA5190
Benz Timing Tool Kit
 For M133 / M270 / M274. Specially designed to position the camshafts in TDC position. Slackens and tightens the bolts attached to the camshaft gears.
 Sale \$431.19 **Tool Club \$344.95**



CTA5080
Benz Timing Tool Kit - M156
 Applications: CLK63 AMG, CLS63 AMG, E63 AMG, ML63 AMG, R63 AMG, CL63 AMG, S63 AMG & C63 AMG
 Sale \$374.94 **Tool Club \$299.95**



CTA1216
Master Benz Timing Set
 Services: M133, M152, M157, M270, M274, M276, M278 engines.
 Sale \$155.31 **Tool Club \$124.25**



CTA3770
Timing Chain Tool Kit - N12, N14 & N16
 Services: N12, N14 & N16 Engines in R55-R61 models 2007-2016 (Cooper, Paceman & Countryman) - 1.6L
 Sale \$312.44 **Tool Club \$249.95**



CTA3772
Valvetronic Spring Tool
 Safely compressing the Valvetronic springs during installation & removal BMW & MINI (R56 - N12 & N14) - 1.6L
 Sale \$562.44 **Tool Club \$449.95**



CTA2857L
5pc Master Cam Locking Kit
 Services Fiat, Ford, Honda, Hyundai, Mazda, Mitsubishi, Nissan, Saab, Subaru, Toyota, Volvo & more! Includes adjustable clamping tool & 4 mini clamps.
 Sale \$69.38 **Tool Club \$55.50**

VW / AUDI CAMSHAFT TOOLS

CTA1036
VW/Audi Camshaft
Adjuster Socket - 2.0L
 Services camshaft adjuster bolts.
 Sale \$18.13 **Tool Club \$14.50**



CTA2762
VW/Audi Camshaft Drivebelt Pulley Puller Kit
 For 4 & 6 cylinder TDI & V6, V8 engines.
 Includes: 3 single arm jaws, 3 double arm jaws, yoke, and center screw.
 Sale \$180.31 **Tool Club \$144.25**



CTA2870
Camshaft Holder Kit - Audi 3.0 L
 For Audi A4, A6 and A8 2000-2007 with AVK engine. Includes holders, lock pin tool, socket, and set of pins.
 Sale \$249.94 **Tool Club \$199.95**



CTA7809
VR6 Camshaft Locking Plate
 MK3 & MK4 Golf (GTI), Jetta, Corrado & Passat (B3 & B4)
 Sale \$24.94 **Tool Club \$19.95**



CTA1414
VW/Audi Timing Tool Kit - 4.2L
 VW/Audi Factory Tool #T40047, T40046, T3242 & T40058. Includes Camshaft locking bars, TDC Lock Pin & Setting Tool.
 Sale \$190.63 **Tool Club \$152.50**



CTA1412
VW / Audi Crankshaft Turning Socket - 4.2L
 Applications 2.4L, 3.2L & 4.2L FSI engines
 Sale \$19.94 **Tool Club \$15.95**



CTA2775
VW TDI Timing Belt Tool Kit
 For '99 and up 1.9L TDI engines with ALH code found on Golf, Jetta, & Beetle.
 Sale \$69.94 **Tool Club \$55.95**



CTA2872
TDC Lock Pin for VW/Audi
 Locks the crankshaft at TDC. Works with 2865, 2867, 2869
 Sale \$31.25 **Tool Club \$25.00**



CTA2777
VW / Audi Timing Tool Kit
 For VAG 2.0L TDI PD DOHC engines on Audi A4, A6, VW, Golf, Jetta, and Touareg.
 Sale \$57.81 **Tool Club \$46.25**



CTA1032
3pc V.A.G. Camshaft Adjusting Socket Set
 For removal and installation of 4/3 way central valve for camshaft adjustment on 1.8 & 2.0 generation III TFSI engines. 3 sizes with unique 2 pin positions.
 Sale \$44.94 **Tool Club \$35.95**



CTA2867
Twin Camshaft Holder
 Applications: VW/Audi V6 2.7L & 2.8L w/ 5 valves per cylinder.
 Sale \$124.94 **Tool Club \$99.95**



CTA5440
5 Pc. Camshaft Adjusting Tool Set - VAG
 Services 1.8L & 2.0L (4v) generation 1, 2 & 3 TFSI engine with chain (2006-2020)
 Sale \$78.13 **Tool Club \$62.50**



CTA2869
Twin Camshaft Holder
 VW/Audi V8 w/ 5 valves per cylinder.
 Sale \$116.56 **Tool Club \$93.25**



CTA2889
VW / Audi 2.0L Turbo Timing Kit
 Services '09 & up models with turbo engines. Includes crank counter hold tool, crankshaft thrust piece, (4) drift for camshaft slide pieces, (2) locking clips, (2) camshaft clips, (1) assembly tool.
 Sale \$243.13 **Tool Club \$194.50**



CTA2878
VW / Audi Camshaft Locking Tool
 Services 2006 - 2008 VW / Audi 2.0L Turbo engines.
 Sale \$57.81 **Tool Club \$46.25**



CTA2760
VW/Audi Adjustable Timing Belt Tensioner 1.5L, 1.6L, 1.7L, 1.8L, 1.9L 2.0L
 Services VW / Audi 4 cylinder 1.5, 1.6, 1.7, 1.8, 1.9 and 2.0L engines.
 OAL: 7-1/2" / 19cm
 Sale \$43.69 **Tool Club \$34.95**



CTA1085
Audi Camshaft Holding Tool
 For assembly and disassembly of pulleys on camshaft, vibration and oil pump. Includes 2 sets of pins, one with 3-steps for a total of 4 diameters.
 Sale \$66.56 **Tool Club \$53.25**



CTA2874
Cam Chain Tensioned Retainer VW / Audi
 Holds the chain and tensioner in the correct position.
 Sale \$21.88 **Tool Club \$17.50**



CTA3830
VW TDI Timing Belt Tool Kit
 Used to properly lock & time the TDI EA288 diesel engine for 2015+ VW models. 2015+ TDI models with engine codes "CVCA" & "CRUA". 2015+ Jetta TDI, Golf TDI, Golf Sportwagen TDI, Beetle TDI & Passat TDI
 Sale \$186.88 **Tool Club \$149.50**



CTA8091
VW TDI Timing Belt Tool Kit - 1.9L
 Sets & adjusts timing on '99 - '08 VW TDI. Lock pins, Cam Lock Bar, Spanner Wrench and Crankshaft Holders.
 Sale \$182.44 **Tool Club \$145.95**



CTA1023
V.A.G. Timing Tool Kit - 1.8L & 2.0L (TSI / TFSI)
 Includes 3pc V.A.G. camshaft adjusting socket | set - 2.0L (TFSI), VW/Audi 2.0T Timing Kit - 2.0L (TFSI), and VW Chain Tensioner Lever.
 Sale \$312.44 **Tool Club \$249.95**



CTA4333
Adjustable Master Camshaft Pulley Holder
 For Mercedes, BMW, Ford, Honda, Audi, VW, and more! Adjustable Range: 21mm - 100mm.
 Sale \$124.94 **Tool Club \$99.95**



CAMSHAFT TOOLS

LIS36880
Dual Cam Holding Tool
 Locks cams in place during belt/chain replacement.
 Sale \$48.13 **Tool Club \$38.50**



CTA5013
Audi A8 4.0L Timing Tool Kit
 Applications: Audi A6, A7 & A8 equipped with the V8 4.0L TFSI direct injection engine
 Sale \$362.44 **Tool Club \$289.95**

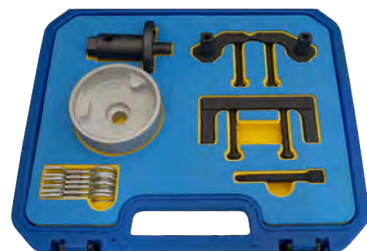

FORD CAMSHAFT TOOLS

GM CAMSHAFT

TIMING TOOLS



OTC6690
Ford Master Cam Tool Kit
 • Combination of OTC6489 & OTC6690-1.
 • Adjust cam timing on ANY Ford car or truck with a timing chain or belt.
 • Works on vehicles from mid 1990's to today's current model year vehicles.
 • Works on 4 cylinder, 6 cylinder, V-8, & V-10 engine configurations.
 • Contains 40 tools and an application chart.
 Sale \$1,112.44 **Tool Club \$889.95**

ALL IN-ONE KIT FOR FORD



OTC6690-1
Ford Cam Tool Update Kit
 Add on set for OTC6489 - making the kit into the OTC6690. Covers L4, V6, V8, V10 engines w/ 3V & 4V valve configurations 2004 - present.
 Sale \$662.44 **Tool Club \$529.95**



OTC6488
7pc Ford Cam Tool Set
 For 1997 - 2011 4.0L Explorer / Mountaineer SOHC V6 engines.
 Sale \$393.69 **Tool Club \$314.95**

OTC6681
Ford Cam Tool Set
 For use on Ford 4.6L, 5.4L & 6.8L 3V engines
 Sale \$74.94 **Tool Club \$59.95**

LIS37410
Ford Cam Tool Kit
 2.0L, 4 cylinder DOHC Zetec.
 Sale \$43.13 **Tool Club \$34.50**

CTA7640U
Ford Camshaft Locking Kit - 4.6L, 5.4L & 6.8L 3V
 One tool locks camshaft and the other locks the timing chain.
 Sale \$145.63 **Tool Club \$116.50**

CTA5068
Ford 1.6L Timing Tool Set
 Timing set for Ford 1.6L (Naturally Aspirated) engine plus the 1.5L/1.6L Ecoboost (Turbocharged)
 Sale \$58.69 **Tool Club \$46.95**



OTC6489
Ford Cam Tool Set
 Master set has 22 cam tools covering 1992+ Ford engines, over 50 applications. Includes cam positioning tools, cam sensor sync tools, and more.
 Sale \$687.44 **Tool Club \$549.95**



CTA5063
Ford/Mazda Timing Tool Kit
 Services Ford, Lincoln & Mazda 1.4L, 1.5L, 1.6L, 2.0L, 2.3L, 2.5L, 3.0L & 3.5L engines
 Sale \$349.94 **Tool Club \$279.95**

LIS37200
Ford Timing Tool with Tensioner
 For use when servicing the timing chain on Ford V6 3.5L & 3.7L Engines
 Sale \$65.63 **Tool Club \$52.50**

CTA2743
Ford 1.6L Ecoboost Engine Service Kit
 Includes timing & seal service tools.
 Sale \$131.19 **Tool Club \$104.95**

CTA2880
Ford / Mazda Cam Alignment Tool
 Services: '04-'09 Mazda 3, '06 - '10 Mazda 5, '05 - '08 Ford Escape, '03 - '07 Ford Focus, '06 - '09 Ford Fusion and including all HWDA, HWDB, & HXDA engines.
 Sale \$41.88 **Tool Club \$33.50**

CTA2884
Ford / Mazda Cam Alignment Tool
 2.0L & 2.3L twin cam turbo engines.
 Sale \$32.19 **Tool Club \$25.75**

CTA5067
Ford 2.0 & 2.3L Ecoboost Timing Tool Kit
 Applications: Edge, Escape, Explorer, Focus, Mustang, Fusion, Taurus, XF, Evoque, MKC, MKT & MKZ
 Sale \$59.94 **Tool Club \$47.95**

CTA2715
Tension Pulley Spanner - Mitsubishi / Hyundai / Chrysler
 Adjusts timing belts that have idler pulleys with pin holes. 10.85mm (.428") pins.
 Sale \$25.63 **Tool Club \$20.50**



CTA5480
Timing Tool Kit - GM Atlas
 Services: I4 2.8L 2800, I5 3.5L 3500, I5 3.7L 3700 Atlas/Vortec engines found in Buick, Chevrolet, GMC, Hummer, Isuzu, Oldsmobile & Saab models
 Sale \$199.94 **Tool Club \$159.95**

CTA4161
GM Camshaft Locking Tool Kit
 For GM 1.6L & 1.8L 16v engines. Applications: Aveo, Cruze, G3, 9-5, Alfa Romeo & Fiat from 2003-2012
 Sale \$81.19 **Tool Club \$64.95**

CTA1046
GM Timing Tool Kit 1.4L Ecotec
 For 2011 & up GM models with the 1.4L Ecotec engine. Applications: Chevy Cruz, Sonic & Trax
 Sale \$262.44 **Tool Club \$209.95**

CTA5460
GM Belt Tension Compressor Tool
 Services GM 2.4L EcoTec (Hybrid) 2011-2016; Buick Regal, LaCrosse, Chevrolet Malibu, Impala & Captiva
 Sale \$78.13 **Tool Club \$62.50**

OTC6687
GM 6-Cylinder Cam Tool Set
 Used to adjust & hold cam shaft timing on GM 3.0 & 3.2 V-6 engines.
 Sale \$299.94 **Tool Club \$239.95**

OTC6685
GM In-Line 4-Cylinder Cam Tool Set
 Designed to save time when servicing GM 4-cylinder engines.
 Sale \$462.44 **Tool Club \$369.95**

CTA5000
Cam Phaser & Timing Chain Locking Holding Set
 Applications: 2011 and newer Chrysler, Dodge and Jeep models with 3.0L, 3.2L & 3.6L Pentastar engines.
 Sale \$181.19 **Tool Club \$144.95**



CTA2112
Valve Spring Compressor Kit
 Replaces valve spring & valve stem seals without removing the cylinder head on most BMW, VW, Audi and Volvo models.
 Sale \$124.94 **Tool Club \$99.⁹⁵**



CTA2235
Overhead Valve Spring Compressor
 Fits all engines with the head on or off of the car. Will fit into the most recessed valve spring.
 Sale \$139.94 **Tool Club \$111.⁹⁵**

PISTON RING COMPRESSOR

CTA2020
Piston Ring Compressor Set
 Sale \$77.81
Tool Club \$62.²⁵



LIS19500
 Range: 2-1/8" to 5"
 Sale \$24.06
Tool Club \$19.²⁵



LIS20500
 Range: 3-1/2" to 7"
 Sale \$24.06
Tool Club \$19.²⁵



LIS21000
Diesel Ring Compressor
 Range: 3-1/2" - 7"; Height: 7"
 Sale \$49.38
Tool Club \$39.⁵⁰



LIS21500
Diesel Ring Compressor
 Range: 7" - 10"; Height: 7"
 Sale \$57.81
Tool Club \$46.²⁵



CTA4021
Piston Ring Compressor
 Depth: 3" (75mm)
 Range: 60 - 175mm
 Sale \$14.38
Tool Club \$11.⁵⁰



CTA4023
Piston Ring Compressor
 Depth: 4" (100mm)
 Range: 53 - 175mm
 Sale \$17.81
Tool Club \$14.²⁵



CTA4024
Piston Ring Compressor
 Depth: 6" (150mm)
 Range: 60 - 175mm
 Sale \$27.44
Tool Club \$21.⁹⁵



VALVE TOOLS

CTA2231
Overhead Valve Spring Compressor
 Removes valve spring keepers and springs without removing the cylinder head. Adjusts to fit springs on most cars. Sliding "T" handle for close clearances.
 Sale \$30.94 **Tool Club \$24.⁷⁵**



LIS44300
Valve Spring Compressor
 High leverage allows one-handed operation. Exceptionally strong, rigid frame. Works with nearly all valve-in head & L-head engines, as well as truck & tractor engines.
 Sale \$131.19 **Tool Club \$104.⁹⁵**



KDT2833D
Glaze Breaker
 Fits cylinders 2" to 7".
 Sale \$44.38 **Tool Club \$35.⁵⁰**



LIS23500
Glaze Breaker
 For cylinders 2" to 7"
 Sale \$39.38 **Tool Club \$31.⁵⁰**

FLEX HONES

Flex-Hones® produce a plateaued finish for fast ring seating and better oil retention for longer engine life.



Part #	Size	Sale	Club
CTA1142	1"	\$36.88	\$29.⁵⁰
CTA1147	1-1/2"	\$47.44	\$37.⁹⁵
CTA1149	1-3/4"	\$48.13	\$38.⁵⁰
CTA1150	2"	\$50.00	\$40.⁰⁰
CTA1152	2-1/4"	\$53.13	\$42.⁵⁰
CTA1154	2-1/2"	\$58.13	\$46.⁵⁰
CTA1156	2-3/4"	\$65.63	\$52.⁵⁰
CTA1158	3"	\$72.44	\$57.⁹⁵
CTA2274	3-1/4"	\$76.88	\$61.⁵⁰
CTA2276	3-1/2"	\$83.44	\$66.⁷⁵
CTA2278	3-3/4"	\$87.44	\$69.⁹⁵
CTA2280	4-1/8"	\$92.44	\$73.⁹⁵
CTA2282	4-5/8"	\$104.94	\$83.⁹⁵
CTA2284	3" H.D.	\$109.69	\$87.⁷⁵
CTA2286	3-1/4" H.D.	\$114.38	\$91.⁵⁰
CTA2288	3-1/2" H.D.	\$117.81	\$94.²⁵
CTA2290	3-3/4" H.D.	\$122.81	\$98.²⁵
CTA2292	4" H.D.	\$132.19	\$105.⁷⁵
CTA2294	4-1/4" H.D.	\$140.31	\$112.²⁵
CTA2296	4-1/2" H.D.	\$149.06	\$119.²⁵
CTA2297	5" H.D.	\$173.69	\$138.⁹⁵
CTA2298	5-1/2" H.D.	\$191.19	\$152.⁹⁵
CTA2400	6" H.D.	\$208.13	\$166.⁵⁰
CTA2401	6-1/2" H.D.	\$225.94	\$180.⁷⁵
CTA2402	7" H.D.	\$229.38	\$183.⁵⁰
CTA2403	7-1/2" H.D.	\$249.94	\$199.⁹⁵
CTA2404	8" H.D.	\$280.63	\$224.⁵⁰

LIS58430
Camshaft Seal Puller
 Removes without damage.
 Sale \$24.38
Tool Club \$19.⁵⁰



CTA1092
Ford Valve Spring Compressor
 For 1991 & up Ford 4.6L 2 valve, V8 engines.
 Sale \$56.25
Tool Club \$45.⁰⁰



CTA7639
Ford Valve Compressor
 Services Ford vehicles with 4.6L, 5.4L & 6.8L 3V Engines
 Sale \$68.69
Tool Club \$54.⁹⁵

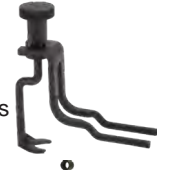

LIS36050
Valve Keeper Tool
 Works on most overhead valve engines with valve stems from 4.5 to 7.5 mm & 5/16" to 3/8".
 Sale \$99.69
Tool Club \$79.⁷⁵



LIS36200
Valve Keeper Tool
 Push or tap with hammer to remove or install keepers.
 Sale \$55.31
Tool Club \$44.²⁵



LIS33500
Piston Ring Installer
 Sale \$9.94
Tool Club \$7.⁹⁵



CTA3012
Remote Control Starter Switch
 Controls any engine with solenoid starter switch.
 Sale \$16.19
Tool Club \$12.⁹⁵



LANG3275A
26 Blade Offset Feeler Gauge
 Sizes: 0.005" - 0.030"
 Sale \$18.69
Tool Club \$14.⁹⁵

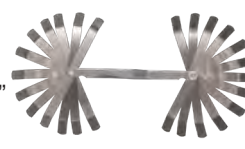

LIS68050
Valve Tappet Feeler Gauge
 11pc Offset steel blades.
 .008-.026 (.203mm-.660mm)
 Sale \$9.94 **Tool Club \$7.⁹⁵**

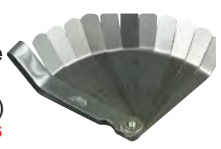

CTA7810
Injector Seat and Chamber Cleaning Set
 (2) metal brushes (Ø 20mm & 25mm) for injector hole cleaning,
 (2) front brushes for injector seat cleaning
 (1) front brush extension (2) seal plugs to close injector hole while cleaning (1) seal plug holder to place & remove plug (1) sanding kit with paper and paper support
 Sale \$129.94 **Tool Club \$103.⁹⁵**



DIESEL COMPRESSION

DIESEL COMPRESSION ADAPTERS AVAILABLE FOR MOST CARS & TRUCKS



MITMV5535 Diesel Compression Tester
 Cummins: 2.9L, 3.9L, 5.9L, 5.9L-24 valve
 Navistar: 6.9L, 7.3L; VW: 1.9L
 GM: 4.3L, 5.7L, 6.2L, 6.5L
 Sale \$337.44 **Tool Club \$269.95**



LANGCLT2PB Cylinder Leakage Tester
 Pinpoints the cause of low compression. Two gauges will monitor air input & compression. Supplements a compression tester.
 Sale \$140.63 **Tool Club \$112.50**

OTC5609 Cylinder Leakage Tester
 Dual 2.5" gauges. Long flex 24" 14mm hose. 10, 12, 18mm thread adapters. Detailed instruction chart.
 Sale \$137.44 **Tool Club \$109.95**



LIS20300 Vacuum Gauge & Fuel Pump Tester
 Sale \$38.44
Tool Club \$30.75



SY15300 EGT Sensor Sockets
 Designed to remove exhaust temperature sensors. 13, 14, & 17mm. Offset & inline sockets.
 Sale \$174.38
Tool Club \$139.50



GASOLINE COMPRESSION



MITMV5532 Gasoline Compression Tester
 Includes: full set of adapters: 10, 12, 14 & 18mm, plus an air hold adapter for holding the valves up.
 Sale \$187.44 **Tool Club \$149.95**

LANGTU30PB Master Gasoline Compression Tester
 Set comes complete with all adapters, all lengths for 10, 12, 14 & 18mm threads. Quick disconnect & a separate small engine tester.
 Sale \$182.81
Tool Club \$146.25



MITMV5530 Professional Compression Test Kit
 For dry and wet engine cylinder compression tests that detect ring or cylinder head problems, sticking valves & blown head gasket(s). Adapters for motorcycles, marine and small engines.
 Sale \$112.44 **Tool Club \$89.95**

LIS20250 Compression Tester
 Fits: 14mm, 14mm long & 18mm threads.
 Sale \$55.31
Tool Club \$44.25



PRESSURE TESTERS



LANGTU16APB Transmission & Engine Oil Pressure Tester
 Features two gauges for accurate testing. Fits most domestic and imported cars.
 Sale \$199.94
Tool Club \$159.95



KDT3343D Transmission & Engine Oil Pressure Tester
 Fits most domestic and imports.
 Sale \$87.44
Tool Club \$69.95



LANGTU24APB Exhaust Back Pressure Gauge
 Three way tester will test at 3 places: Oxygen Sensor, Exhaust Pipes, Air Injection System.
 Sale \$144.69
Tool Club \$115.75



LANGTU22APB Power Steering Pressure Tester
 Adapters will fit most domestic and imported cars.
 Sale \$151.56 **Tool Club \$121.25**



SURKP1500 DELUXE Fuel Line Replacement Kit
 Cost-Effective – Save up to 70% vs. OEM fuel lines
 Easy-to-use – No special insertion tools required; reduces labor time
 Complete Coverage – Works with Domestic & Foreign Vehicles
 Safe – Nylon lines hold up to 200 PSI
 Versatile – Safe for use with multiple fuel types including gas, ethanol and diesel
 Includes 168 Pieces plus 75' Tubing!
 Sale \$499.94 **Tool Club \$399.95**



FUEL LOCK



CTA2493 Volvo Fuel Tank Lock Ring Wrench
 For all late model Volvos including S60, S80, V70, V70 XC, XC70 & XC90. 1/2" square drive.
 Sale \$81.19 **Tool Club \$64.95**



LT940 Fuel Tank Wrench
 Removes plastic fuel pump retaining rings. Increased length for wider applications.
 Sale \$27.44 **Tool Club \$21.95**



CTA1044 Toyota/Lexus Fuel Tank Lid Wrench
 Works on many Toyota & Lexus vehicles from 2004 & up. 9 slot design with 173mm OD & 143mm ID. 3/8" Dr.
 Sale \$43.69 **Tool Club \$34.95**



LIS62970 Fuel Tank Lock Ring Kit
 Channel design allows 2 interchangeable sets of legs to adjust to fit rings from 4" - 7-1/4". Works on many 2004 & newer vehicles including Ford, Chevrolet, Chrysler/Dodge, PT Cruiser, Dakota & Durango.
 Sale \$79.38 **Tool Club \$63.50**



LIS63000 Fuel Tank Lock Ring Tool
 Range: 4" to 7-1/4"
 Sale \$53.13
Tool Club \$42.50



SY69800 Volvo Fuel Pump Socket
 For all late model Volvos.
 Sale \$65.63
Tool Club \$52.50



CTA2492 Universal Fuel Tank Lock Wrench
 1/2dr Prevents damage to the plastic lock ring for fuel pump service.
 Sale \$81.19 **Tool Club \$64.95**





LANG TOOLS

LANGTU550
Master Global Fuel Injection Test Kit
 Covers all major domestic and foreign platforms from 1988 - present. Test gauge assembly disconnects from test hose and valve assembly for easier storage. Fuel line tee can accommodate 3/8", 1/4", & 5/16" hose sizes.
 Sale \$543.69 **Tool Club \$434.95**

LANGTU470B
Fuel Injection Cleaner
 Two gauges to check vehicle fuel pressure and set cleaning pressure. Restores original spray pattern and cleans carbon.
 Sale \$312.44
Tool Club \$249.95



DIESEL FUEL PRESSURE TESTERS



LANGTU32
Master Fuel System Test Kit - Cummins 5.9L
 Compound pressure/vacuum gauge, fuel pressure test adapters, inlet restriction test adapters, and fuel volume test adapters. For Cummins Series B & ISB engines.
 Sale \$537.44 **Tool Club \$429.95**

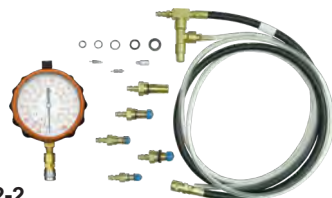

LANGTU32-2
Basic Diesel Fuel Pressure Test Kit
 100 PSI gauge assembly, 4' hose, pressure relief valve, and 6' clear PVC tube, 5 banjo bolt adapters, and repair kit. Used on single cylinder to V32 diesel engines.
 Sale \$256.19 **Tool Club \$204.95**

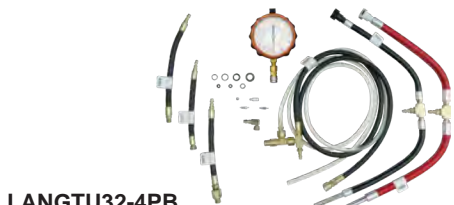

LANGTU32-4PB
Ford Power Stroke Diesel Fuel System Kit
 1994 - present. Use adapters to test at fuel filter and fuel pump. Includes 100 PSI gauge, bleed off valve hose assembly, & all adapters necessary.
 Sale \$364.38 **Tool Club \$291.50**



CTA3300
Fuel Injection Pressure Tester
 Checks PFI (Port-Fuel-Injected) and TBI (Throttle-Body-Injected) systems on most vehicles. Includes 3-1/2" gauge with dual calibrations (5-145 PSI / 25-1,000 kPa), 2-1/2" gauge with dual calibrations (0-15 PSI and 0-1.00 kg/cm2) and complete range of adapters and hose assemblies. MADE IN USA.
 Sale \$412.44 **Tool Club \$329.95**



CTA3350
Fuel Injection Pressure Tester
 Kit for most domestic and Asian fuel injection systems, except GM TBI.
 Sale \$137.44
Tool Club \$109.95



AST7898
Deluxe Noid Light & IAC Tester Set
 Noid lights plus two GM IAC testers.
 Sale \$26.19 **Tool Club \$20.95**



LANG71319
Small Schrader Hose
 Sale \$24.69 **Tool Club \$19.75**



LANG71318
Standard Schrader Hose
 Sale \$20.63 **Tool Club \$16.50**



CTA8877
VW/Audi Fuel Injector Puller/Remover
 Fuel Injector puller. Installation and removal of high pressure injectors. Installs combustion chamber seal. Services VW and Audi with direct injection FSI system.
 Sale \$152.19 **Tool Club \$121.75**



CTA7808
Injector Puller Kit
 Removes frozen or cracked injectors without removing the electrical part. Includes connectors M12 & M14.
 Sale \$384.38 **Tool Club \$307.50**



COMBUSTION LEAK

UV560000
Combustion Leak Tester
 Dual chamber design for higher accuracy to eliminate false readings. Includes tester and fluid. UV560500 for replacement fluid.
 Sale \$83.69 **Tool Club \$66.95**



LIS75500
Combustion Leak Detector
 Detects exhaust gases in radiator fluid for gasoline engines. Order #75730 for Diesel.
 Sale \$48.44 **Tool Club \$38.75**



LIS75630
Combustion Leak Indicating Fluid
 Sale \$10.31 **Tool Club \$8.25**



LIS75730
Combustion Leak Indicating Fluid for Diesel
 Sale \$10.31 **Tool Club \$8.25**

OTC6768
Ford 6.0L Glow Plug Removal Tool
 For 2004 - 2009 Ford 6.0L diesel engines.
 Sale \$37.44 **Tool Club \$29.95**



CTA7999
IPR Socket - Ford 6.0L **NEW!**
 Easily remove and install the injector pressure regulator in a '03-'07 6.0L Power Stroke engine.
 Sale \$28.69 **Tool Club \$22.95**



CTA7468
4pc. Injection Line Wrench Set
 2220X14 - 14mm
 2220X17 - 17mm
 2220X19 - 19mm
 5069 - 22mm
 1/2" Sq Dr. 12 pt "Bi-hex" wrenches. Includes case.
 Sale \$112.44 **Tool Club \$89.95**



CTA6515
Ford Fuel Injector Connector Disconnect Tool
 6.4L Powerstroke injector. Spring loaded design allows for easy removal of connector.
 Sale \$49.94 **Tool Club \$39.95**



CTA7798
Ford Fuel Injector Puller Remover Tool
 Services: Ford EcoBoost GDI engines (1.0L, 2.0L & 3.5L)
 Sale \$124.94 **Tool Club \$99.95** **NEW!**



CTA7806
Injector Seal Extraction Kit **NEW!**
 Removes clogged or stuck diesel injector seals. Kit includes: (2) conical removers with double thread entry that services both passenger and light-duty utility vans & trucks.
 Sale \$268.69 **Tool Club \$214.95**



SENSOR TOOLS

AST7801

7pc Sensor & Sending Unit Socket Set

Allows the removal of oil pressure sending units on late 1980 and mid 1990 GM vehicles.

Sale \$78.69 **Tool Club \$62.95**



KDT41720

8pc Sensor & Sending Socket Set

Designed for removal and installation of oxygen sensors, oil pressure sending units and vacuum switches.

Sale \$87.44 **Tool Club \$69.95**



WILW84007

Flex Head Oxygen Sensor Wrench

22mm (7/8) hex. Curved handle.

Sale \$21.19 **Tool Club \$16.95**



LIS12390

Dual Drive Oxygen Sensor Wrench

Both 1/2" & 3/8" openings for a breaker bar.

Sale \$31.88 **Tool Club \$25.50**



SY66750B

Shielded Oxygen Sensor Wrench

Removes & replaces shielded oxygen sensors on Toyota, Lexus & Mazda.

Sale \$42.44 **Tool Club \$33.95**



SY93750B

2 Sided Offset Oxygen Sensor Wrench

2-1/8" offset. For foreign and domestic applications. 6 & 12 point design.

Sale \$43.69 **Tool Club \$34.95**



LIS12100

Oxygen Sensor Socket

Sale \$19.38 **Tool Club \$15.50**



KDT3920D

Sensor Socket

For removing oxygen sensors, vacuum, TVS, PVS, & vacuum switches.

Sale \$21.19 **Tool Club \$16.95**



CTA7850

Ford Flow Sensor Socket - 19mm

3/8" Drive. Thin wall design

Sale \$19.94 **Tool Club \$15.95**



LIS12230

Oxygen Sensor Thread Chaser

Stubby design for tight spaces.

Sale \$7.19 **Tool Club \$5.75**



BEARING & SEAL

AST7824

Bearing Driver

Sizes: 1.565" to 3.180"

Sale \$67.50 **Tool Club \$54.00**



LIS12800

Bearing & Seal Driver

Features an adapter for air hammers as well as for hand use. 11 drivers.

Range: 1.56" to 3.2"

Sale \$144.38

Tool Club \$115.50



LIS59400

Pinion Bearing Driver

For inner & outer pinion races on 1/2 & 3/4 ton Dodge, Ford, and GM pickups. 8 drivers.

Range: 2-11/16" - 4-1/2"

Features: Air hammer adapter.

Sale \$176.56

Tool Club \$141.25



LIS61850

5pc Truck Hub Seal Installer Kit

Fits the most popular sizes for class 7 & 8 over the road trucks & trailers & some medium duty trucks.

Sale \$287.44

Tool Club \$229.95



LIS61900

H.D. Bearing Race & Seal Driver Set

Fits most Class 8 over the road trucks & trailers & some medium duty trucks.

Sizes: 3-43/64", 4-7/8", 4-13/16", 5-1/2", 5-25/32", 6"

Sale \$262.44

Tool Club \$209.95



CTA8492

Internal Bearing Remover Set

Removes Captured Bearings, Pilot Bearings, Bushings. Positive grip design prevents slippage

Sale \$230.94 **Tool Club \$184.75**

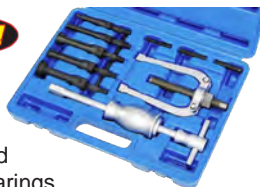

AST78415

Locking Pliers Slide Hammer Puller

Universal puller for locking onto and hammering to remove everything from cotter pins to old seals and bushings

Sale \$68.69 **Tool Club \$54.95**



TIT51362

Blind Hole Puller

For pulling pilot bearings and other jobs requiring an internal pull.

Sizes: 3/8" to 1-1/4"

Sale \$181.88 **Tool Club \$145.50**



OTC27794

Custom-Made Driver Tools Basic Set

Have the proper size driver for nearly any automotive seal, bearing, or bushing installation job! Set includes two(2) Handle sizes & 41 discs, ranging from 1/2" to 3" diameter, in 1/16" increments. All discs are 1/2" thick.

Plastic storage box & insert.

Sale \$662.44 **Tool Club \$529.95**



MAY62015

4pc Bearing Race Punch Set

Remove bearings without damage.

Oval tips. For all bearing races.

Sale \$110.94 **Tool Club \$88.75**

SEAL PULLERS

LIS56750

Seal Puller

Sale \$14.94

Tool Club \$11.95



LIS56650

Adjustable Seal Puller

Head adjusts to five positions.

It will reach in tight spaces.

Sale \$21.88 **Tool Club \$17.50**



AST9519

3pc Seal & O-Ring Puller Set

Sizes: 4.6", 6" & 6.5". Quickly & easily removes O-Rings, grease & oil seals.

Sale \$22.44 **Tool Club \$17.95**



SERPENTINE BELT

HARMONIC BALANCER

SPECIALTY PULLERS



KDT3680D
14pc GearWrench **GEARWRENCH**
Flex Head Serpentine Belt Set
 Includes long bar, special Gearwrench Ratcheting wrench, 3/8", 1/2", and 3/4" adapters, 7 sockets, and 3 crowsfoot.
 Sale \$90.00 **Tool Club \$72.00**



KDT89000
15pc Serpentine Belt Tool Kit
 Includes 3/8" drive locking flex ratcheting wrench, long bar, 3 adapters, 7 6-point sockets & 3 crowsfoot sockets.
 Sale \$112.44 **Tool Club \$89.95**



LIS59800
Serpentine Belt Tool
 Fits idler pulleys requiring 13, 14, 15, 16 and 18mm as well as 19mm hex.
 Comes in both 3/8" & 1/2" square drive sizes.
 Sale \$74.94 **Tool Club \$59.95**



LIS59650
11pc Ratcheting Serpentine Kit
 Fits idler pulleys requiring 13, 14, 15, 16 and 18 mm as well as 19mm hex.
 Comes in both 3/8" & 1/2" square drive sizes.
 Sale \$123.13 **Tool Club \$98.50**



LIS59670
11pc Serpentine Belt Kit
 Fits idler pulleys requiring 13, 14, 15, 16 and 18mm as well as 19mm hex.
 Comes in both 3/8" & 1/2" square drive sizes.
 Sale \$111.56 **Tool Club \$89.25**

CTA3458
BMW A/C Belt Installation Tool
 Designed for use on BMW V8 N62 Vehicles. Specifically Crafted for BMW year 2004 to 2006 Models.
 Sale \$37.44 **Tool Club \$29.95**



LIS59370
Stretch Belt Remover / Installer
 Magnetic faces hold the tool in place on the pulley.
 Sale \$27.19 **Tool Club \$21.75**



AST7846
Harmonic Balancer Puller
 For harmonic balancers, crankshaft pulleys, steering wheels & gear pulleys.
 Sale \$65.63
Tool Club \$52.50



LIS45500
Harmonic Balancer Puller
 Helps stop damage to pulley & shaft. Designed to ease the operation of pulling the balancer pulley.
 Sale \$41.19 **Tool Club \$32.95**

LIS53790
Harmonic Balancer Installer Kit - 13 Adapters
 Use to install harmonic balancers or drive pulleys that are pressed on one or two groove pulleys on the crankshaft. Good for Dodge Hemi, Generation III & IV GM motors, some Chrysler & some Ford.
 Sale \$218.69 **Tool Club \$174.95**



CAL38800
Harmonic Balancer Installer
 Use to install harmonic balancers or drive pulleys that are pressed on one or two groove pulleys on the crankshaft.
 Sale \$69.06 **Tool Club \$55.25**



PULLEY PULLERS



KDT2897D
Pulley Puller
 For alternator and power steering pulleys, including Ford Quad 4.
 Sale \$89.38 **Tool Club \$71.50**

LIS39000
No Slip Pulley Puller
 For most domestic vehicles. Works on traditional V-shaped & serpentine belt system pulleys.
 Sale \$86.56 **Tool Club \$69.25**



AST7874
Pulley Puller
 For alternator, power steering and air pump.
 Sale \$37.44
Tool Club \$29.95



LIS54810
Harmonic Balancer Puller Set
 Kit includes a standard harmonic balancer puller, pulling screws, adapters for 3300 & 3800 GM V6 engines, & a harmonic damper pulley puller for Chrysler, GM, Mitsubishi, & Dodge, 3.6L V6 Chevrolet Camaro & Dodge 5.7L Hemi.
 Sale \$249.94 **Tool Club \$199.95**

LIS51450
Harmonic Damper Pulley Puller
 For GM, Chrysler & Mitsubishi.
 Sale \$117.44
Tool Club \$93.95



AST78450
HD Harmonic Crank Pulley Puller
 Use to crank pulley dampeners without female threaded holes. Heavy Duty Grade 9 Drive Bolt.
 Sale \$72.48
Tool Club \$57.98



CAL38000
Ratcheting Harmonic Balancer Puller
 Remove harmonic balancers without the hassle of trying to start bolts or the frustration of positioning multi jointed puller legs.
 Sale \$83.69 **Tool Club \$66.95**



CAL38710
Ford EcoBoost Long Reach Harmonic Balancer Installer
 Nut and bearing sleeve assembly reduces friction while ensuring a proper fit.
 Sale \$42.44 **Tool Club \$33.95**



SY60100A
High Offset Damper Pulley Tool
 4" long offset. For many 2004+ SUV's plus older Honda / Acura engines.
 Sale \$78.13
Tool Club \$62.50



TIT51700
Crankshaft Pulley Holder
 1992+.
 Sale \$33.69
Tool Club \$26.95



TOOLS
 SCHLEY PRODUCTS INC.

TITAN

CTA4245
CV Joint Puller
 1-7/8" 48mm wide opening.
 Sale \$31.88
Tool Club \$25.⁵⁰



WILW87024
Alternator Pulley Service Kit
 Service late model foreign & domestic vehicles with either OWC or OAD alternator pulleys.
 Sale \$99.94 **Tool Club \$79.⁹⁵**



LIS57650
5pc Alternator Decoupler Tool Set
 Removal and installation of ADP (one way and overriding/freewheeling)
 Sale \$42.19 **Tool Club \$33.⁷⁵**



OTC5940
BMW Head Bolt Socket
 Works on M42 & M50 engines. Spring loaded tip will hold the bolt in place.
 Sale \$39.94
Tool Club \$31.⁹⁵



HEAD BOLT

VIMHB100
Toyota Head Bolt Socket
 For Paseo and Tercel.
 Sale \$18.69
Tool Club \$14.⁹⁵



VIMV3452
VW / Audi Head Bolt Socket
 Works on Polydrive head bolt.
 Sale \$14.38
Tool Club \$11.⁵⁰



CV BOOT PLIERS

LIS30600
Offset Boot Clamp Pliers
 Crimps ear-type clamps in hard-to-reach areas.
 Sale \$39.38 **Tool Club \$31.⁵⁰**



LIS30500
CV Boot Clamp Pliers
 For Earless type clamps.
 Sale \$30.63
Tool Club \$24.⁵⁰



LIS30800
CV Boot Clamp Pliers
 For Ear type clamps.
 Sale \$39.38
Tool Club \$31.⁵⁰



LIS30950
CV Boot Clamp Pliers
 For band type clamps.
 Sale \$15.63
Tool Club \$12.⁵⁰



LIS60900
Heater Core Backflush Tool
 Adjustable pressure industrial spray gun and stepped tip design for easy heater core flushing.
 Sale \$47.81 **Tool Club \$38.²⁵**



LIS50210
Gasket Separator
 For use on any application with a gasket seal, such as oil pans, transmission pans & differential covers.
 Sale \$32.19 **Tool Club \$25.⁷⁵**



LIS88500
Radiator Genie
 Water & Air Cleaning Wands for High Efficiency Cooling Systems and All Types of Radiators
 Sale \$37.44 **Tool Club \$29.⁹⁵**



LIS22500
Thermostat Gasket Cleaner
 8-1/4" long. Use with a die grinder to quickly clean gasket surfaces in inaccessible applications.
 Sale \$28.69 **Tool Club \$22.⁹⁵**



OTC5025
DEF Refractometer
 Calibrated scale with 32.5% to see if vehicle meets 2010 EPA regulations for diesel engines.
 Sale \$144.38 **Tool Club \$115.⁵⁰**



TIT51500
Radiator Fin Combs
 Straighten and clean your A/C condenser and evaporator fins
 Sale \$14.38 **Tool Club \$11.⁵⁰**



STEERING WHEEL

LIS45000
Steering Wheel Puller
 Includes adapters for tilt and telescoping wheels.
 Sale \$29.69 **Tool Club \$23.⁷⁵**

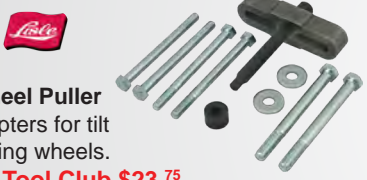

LIS57340
Steering Wheel Lock Plate Tool
 Fits most domestic lock plates.
 Sale \$30.63 **Tool Club \$24.⁵⁰**



KDT41620D
Steering Wheel Puller Kit
 Includes all adapters for steering wheels & lockplates. Pulls crankshaft pulleys on Chrysler 2.2 & 2.5.
 Sale \$90.63 **Tool Club \$72.⁵⁰**



TA66400
Steering Wheel & Brake Pedal Holder
 Fits on virtually all cars and trucks.
 Sale \$43.69
Tool Club \$34.⁹⁵



LANG950
Gasket Hole Punch Set
 10 punch sizes from 1/4" to 1"
 Sale \$56.19
Tool Club \$44.⁹⁵



LIS23800
Flywheel Turner
 This will hold or turn most flywheels and flexplates.
 Sale \$46.19
Tool Club \$36.⁹⁵



LIS48700
40" Throttle Pedal Depressor
 Holds throttles at a constant RPM.
 Sale \$38.69 **Tool Club \$30.⁹⁵**

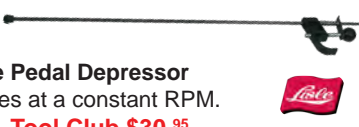

LIS46170
Hood Prop
 Extends from 20" to 48"
 Includes extra foot.
 Sale \$57.81 **Tool Club \$46.²⁵**



LIS52750
Dual Stethoscope Kit
 Has a metal tip for mechanical sounds & a funnel for air sounds.
 Sale \$35.31
Tool Club \$28.²⁵



FAN CLUTCH

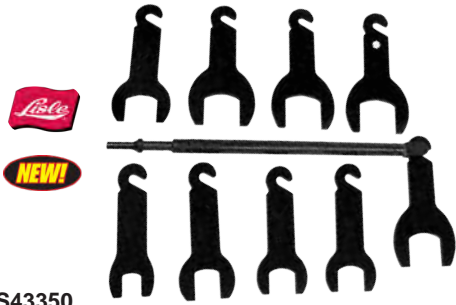

LIS43350
10pc Pneumatic Fan Clutch Wrench Set,
 7/8", 32mm, 36mm, 40mm Thin, 47mm,
 1-7/8", 2", 52mm, and 2-1/8".
 Use with an air hammer.
 Sale \$187.44 **Tool Club \$149.95**



KDT41580D **GEARWRENCH**
Fan Clutch Service Kit
 Includes: 22mm, 36mm, 40mm, 47mm,
 and 50mm wrenches. Includes universal
 pulley holder, small pin set & large pin set.
 Sale \$162.44 **Tool Club \$129.95**



CTAA886
BMW Fan Clutch Wrench Kit
 One tool removes lock nuts on fan,
 while other tool holds the water pump
 pulley while loosening the radiator fan.
 Sale \$48.44 **Tool Club \$38.75**



CTAA872M
Fan Clutch Wrench 36 x 48mm & Holder
 Use both wrench and holder to remove and
 install fan clutch assemblies when replacing
 water pumps or doing other engine services.
 Sale \$74.94 **Tool Club \$59.95**



CAL752
Variable Pin Spanner Wrench
 Fits on pulleys that feature holes or slots,
 including crankshaft and camshaft pulleys.
 Adjustable: 1-1/4" up to 5".
 Fits: 3.5, 4, 4.5, 5, 6, 7 & 10mm Pins.
 Sale \$73.69 **Tool Club \$58.95**

WILW30781
1" to 6" SAE Black Oxide
Adjustable Face Pin
Spanner Wrench
 Versatile 4mm pins
 Sale \$15.94 **Tool Club \$12.75**

WATER PUMP

CTA8069
Ford Water Pump
Pulley Tool - 3.0L
 Removes & installs
 water pump pulley on
 3.0L DOHC engines.
 Sale \$98.13
Tool Club \$78.50



LIS14440
GM Northstar Water
Pump Remover
 For GM Northstar 4.0L
 and 4.6L engines.
 Sale \$33.44
Tool Club \$26.75
LIS13800
GM Ecotec Water
Pump Sprocket Holder
 Sale \$46.19
Tool Club \$36.95



LOCK OUT TOOLS



ACC-ERK
Emergency Response Kit
 Designed by first responders. Emergency ready.
 Most popular accessories. Gets into any vehicle.
 Sale \$172.19 **Tool Club \$137.75**



ACC-OHJS4
One Hand Jack Set
 Designed for all vehicles. Comes with quick DVD.
 Store-N-Go handle. Scratch-proof coating.
 Sale \$92.44 **Tool Club \$73.95**

ACC-BM
Big Max
 58" long. Pre-bent at a precise location
 Sale \$44.69 **Tool Club \$35.75**

LT275
Inflate-A-Wedge™
 Will safely wedge the
 door without damage.
 Sale \$45.31 **Tool Club \$36.25**

ACC-SAW
Super Air Wedge
 Won't damage the vehicle.
 Perfect for medium size
 vehicles to SUV's & trucks.
 Sale \$49.06 **Tool Club \$39.25**



ACC-ULRK
Ultimate Long Reach Kit
 Most popular tools and comprehensive kit.
 Easy to transport. Perfect for beginners & pros!
 Sale \$304.06 **Tool Club \$243.25**



LT140
2pc Inflate-A-Wedge™ Kit
 Features a 53" rigid tool, a slim jim, two
 plastic wedges, plus an inflatable wedge.
 Sale \$78.13 **Tool Club \$62.50**

TA15500
24" Door Unlocking Tool
 For vehicles having lock mechanisms accessible via
 the opening between the top of the door and the
 window glass.
 Sale \$14.06 **Tool Club \$11.25**

SPANNER WRENCHES

WILW30784
Adjustable Hook Wrench
 Fits 2" to 4-3/4"; 50 to 120mm.
 Sale \$48.69 **Tool Club \$38.95**

WILW30785
Adjustable Hook Wrench
 Fits 4-1/2" to 6-1/4"; 114 to 160mm.
 Sale \$64.06 **Tool Club \$51.25**

CTA8605 Large
 Fits 2" to 6"; 51 to 152mm
 Sale \$59.94
Tool Club \$47.95

OTC4791
3/4" - 2" Spanner Wrench
 Chrome vanadium hardened steel wrench.
 5" handle and slim strong hook.
 Sale \$36.19 **Tool Club \$28.95**

OTC4792
2" - 4-3/4" Spanner Wrench
 Chrome vanadium hardened steel wrench.
 9" handle and slim strong hook.
 Sale \$56.88 **Tool Club \$45.50**

CTA8600
Adjustable Gland
Nut Wrench
 Fits 1" to 3-3/4"; 25 to 95mm.
 Sale \$37.44
Tool Club \$29.95



SPECIALTY PULLERS

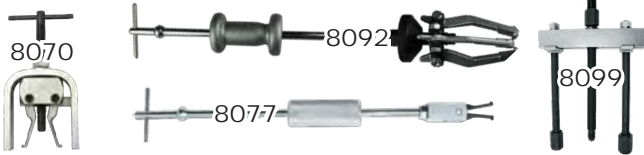

Part #	Description	Sale	Club
CTA8070	Screw Type Bearing Puller	\$59.38	\$47.⁵⁰
CTA8077	Slide Hammer Bearing Puller	\$75.63	\$60.⁵⁰
CTA8099	Push Puller	\$91.56	\$73.²⁵

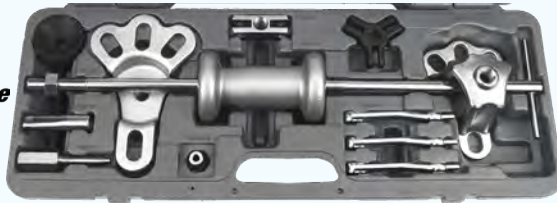

WILW89725

Slide Hammer Puller Set

Slide hammer with multiple attachments: 2/3 Jaw internal and external pullers, 2 rear axle pullers, locking plier adapter, puller hook & dent puller. Sale \$143.69 **Tool Club \$114.⁹⁵**



SUN3911

Professional Slide Hammer Puller Set

Includes: 5lb HD slide hammer, dent puller, 8 function internal or external 2-jaw/3-jaw puller, seal puller hook, rear axle puller plate, and metal box. Sale \$129.94 **Tool Club \$103.⁹⁵**

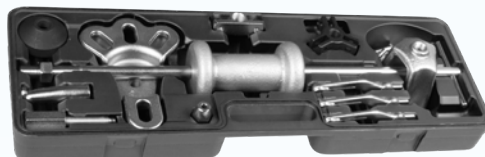

TIT51310

Slide Hammer Puller Set

Includes: 5lb slide hammer, front hub puller, rear axle puller, external 3 jaw puller, internal 3 jaw puller, external 2 jaw puller, internal 2 jaw puller, puller hook, dent puller and grip wrench. Sale \$137.44 **Tool Club \$109.⁹⁵**



OTC4579

9-Way Slide Hammer Puller Set

2-Way Cross Block, Front Hub Puller, Internal 3-Jaw Puller, External 3-Jaw Puller, Rear Axle Puller, Internal 2-Jaw Puller, External 2-Jaw Puller Grip Wrench Adapter, Dent Puller, Puller Hook. Sale \$187.44 **Tool Club \$149.⁹⁵**



OTC1183

Bearing Splitter Set

Features: 4 bearing splitters up to 9", plus a pulley puller with a range up to 5-7/8". Sale \$624.94 **Tool Club \$499.⁹⁵**

2 JAW PULLERS



Part #	Spread	Reach	Sale	Club
OTC1020	3-1/4"	2-1/8"	\$55.31	\$44.²⁵
OTC1022	4"	3-1/4"	\$60.31	\$48.²⁵
CTA8000B	4"	3-1/2"	\$39.94	\$31.⁹⁵
OTC1028	4-1/2"	3-1/2"	\$124.94	\$99.⁹⁵
OTC1025	6"	3-1/4"	\$168.13	\$134.⁵⁰
OTC1031	6"	3-1/4"	\$124.94	\$99.⁹⁵
CTA8005B	6"	3-1/2"	\$54.94	\$43.⁹⁵
CTA8010	7"	5-1/2"	\$72.44	\$57.⁹⁵
OTC1036	9-1/2"	8-3/4"	\$111.88	\$89.⁵⁰
CTA8020	10"	9"	\$118.13	\$94.⁵⁰
CTA8030	15"	5"	\$178.13	\$142.⁵⁰

3 JAW PULLERS



Part #	Spread	Reach	Sale	Club
OTC1021	3-1/4"	2-1/8"	\$65.63	\$52.⁵⁰
KDT3624D	3-1/4"	2-5/8"	\$82.44	\$65.⁹⁵
CTA8035B	4"	3-1/2"	\$44.69	\$35.⁷⁵
OTC1023	4-3/4"	3-1/4"	\$66.88	\$53.⁵⁰
OTC1026	7"	3-1/4"	\$87.44	\$69.⁹⁵
CTA8040B	7"	3-1/2"	\$61.88	\$49.⁵⁰
OTC1027	7-1/2"	5-1/2"	\$90.31	\$72.²⁵
CTA8045B	8"	5-1/2"	\$80.94	\$64.⁷⁵
CTA8050B	10"	5-1/2"	\$131.19	\$104.⁹⁵
OTC1037	10-1/2"	5"	\$162.44	\$129.⁹⁵
OTC1038	11"	8-3/4"	\$149.94	\$119.⁹⁵
CTA8057	14"	11"	\$187.44	\$149.⁹⁵

BEARING SPLITTERS



Part #	Range	Sale	Club
OTC1122	1/8" - 2"	\$78.69	\$62.⁹⁵
CTA8060	0 - 2-1/4"	\$41.19	\$32.⁹⁵
CTA8065	0 - 4-1/4"	\$85.63	\$68.⁵⁰
OTC1123	1/2" - 4-5/8"	\$124.38	\$99.⁵⁰
OTC1124	1/2" - 5-3/4"	\$249.94	\$199.⁹⁵
CTA8150	0 - 6"	\$174.94	\$139.⁹⁵
CTA8155	0 - 8"	\$281.19	\$224.⁹⁵
OTC1130	1/2" - 9"	\$287.44	\$229.⁹⁵

INNER TIE ROD



NEW!

LIS58100
12pc Inner Tie Rod Tool Set
 Improved socket design to work on longer applications. The long socket slips over tie rod end and crows foot engages on socket for easy removal and installation of tie rods with inaccessible wrench flats. Includes 12 crowsfeet, sizes 1-3/16", 1-1/4", 1-3/8", 1-1/2", 1-5/16", 1-7/16", 29mm, 32.5mm, 33.6mm, 38.4mm, 40mm and 42mm, to fit many cars, trucks and SUVs.
 Sale \$193.69 **Tool Club \$154.95**

MAY29912
4pc Interchangeable Inner Tie Rod Tool Kit
 Includes three (3) interchangeable cages that fit tie rods ranging from 28-45mm.
 Sale \$274.94
Tool Club \$219.95



LIS45750
6pc Inner Tie Rod Set
 Sizes 33.6mm, 1-3/16", 1-1/4", 1-5/16", 1-7/16", & 1-1/2".
 Sale \$104.94
Tool Club \$83.95



CTA7878
Sway Bar Link Parrot Nose Pliers
 Adjustable. Holds & removes sway bar link. Clamps & grips rusted or stripped nuts, pipes, screws & more.
 Sale \$41.88 **Tool Club \$33.50**



CTA4014
Inner Tie Rod Tool
 Removes inner tie rods without removing outer tie rods.
 Sale \$28.13 **Tool Club \$22.50**



OTC **NEW!**
OTC5068
Truck Tie Rod Socket
 Designed to withstand the force of a 3/4" drive impact wrench. Works on inner and outer tie rod ends on 12,000 to 16,000 lb truck axles. This rugged socket makes truck tie-rod end removal quick and simple.
 Sale \$199.94 **Tool Club \$159.95**



EXHAUST HOSE

No couplers are needed. Hoses will thread into each other.



Part #	Hose Size	Sale	Club
CRUFLT250	2-1/2"	\$137.44	\$109.95
CRUFLT300	3"	\$165.31	\$132.25
CRUFLT400	4"	\$247.81	\$198.25
CRUACT500	5"	\$336.88	\$269.50



CRUDSS30
3" Complete Exhaust Service Station
 Includes (3) 3" exhaust hoses, (2) 4" sections, (1) 6' section, splicer, tailpipe, and Y adapters.
 Sale \$344.06 **Tool Club \$275.25**



TAILPIPE ADAPTERS

Part #	Fits Hose	Sale	Club
CRUF300	2.5" & 3"	\$40.94	\$32.75
CRUF350	3" & 4"	\$58.13	\$46.50
CRUF400	4"	\$82.81	\$66.25



ACCESSORIES

Part #	Pipe Size	Sale	Club
CRUADF30	3" Door Port	\$55.31	\$44.25
CRUADF40	4" Door Port	\$74.06	\$59.25
CRURY25	2.5" Y Adapter	\$46.88	\$37.50
CRURY30	3" Y Adapter	\$49.69	\$39.75



SLACK ADJUSTMENT

LANG **TOOLS**
LANG8569
9/16" XL Automatic Slack Adjuster
 For trucks equipped with Bendix. Extra deep.
 Sale \$53.69 **Tool Club \$42.95**



LANG7578
7/16" XL Slack Adjuster Wrench
 For trucks equipped with Haldex. Extra deep.
 Sale \$42.81 **Tool Club \$34.25**



LANG4651
Automatic Slack Adjuster Release Tool & Wrench
 Fork end tool to release the tensioner button and 5/16" double square reversible wrench.
 Sale \$61.19 **Tool Club \$48.95**



Falle

 MADE IN USA



LIS17350
Pipe Stretcher Kit
 Use with an impact wrench to expand exhaust pipes from 1-5/8" to 4-1/4".
 Sale \$282.44 **Tool Club \$225.95**

LANGTU24APB
3-Way Exhaust Back Pressure Kit
 Tests thru Oxygen Sensor, Exhaust Pipes & Air Injection System. Includes 6ft. hose and special gauge.
 Sale \$144.69
Tool Club \$115.75



LIS32500
Tailpipe Expander
 Range 1-5/8" to 2-7/16"
 Sale \$54.38 **Tool Club \$43.50**



KDT2031DD
Tailpipe Cutter
 Cuts pipes 3/4" to 3"
 Sale \$68.69 **Tool Club \$54.95**



LIS38350
Exhaust Removal Pliers
 Separates hanger brackets from rubber supports.
 Sale \$31.56 **Tool Club \$25.25**



LIS32000 Pipe End Shaper
 Rounds crushed pipes.
 Sale \$52.44 **Tool Club \$41.95**



DUAL PIPE ADAPTERS

Part #	Pipe Size	Sale	Club
CRUF475	2"	\$55.63	\$44.50
CRUF575	3"	\$68.69	\$54.95



Ken-Tool **NEW!**
KEN33210
4pc Slack Adjuster Set
 Includes Automatic Slack Adjuster Set (Meritor), 7/16" Haldex® Slack Adjuster Tool and 9/16" Bendix® Slack Adjuster Tool.
 Sale \$162.44 **Tool Club \$129.95**



KEN33200
Automatic Slack Adjuster Release Tool & Wrench
 Fork end tool to release the tensioner button and 5/16" double square reversible wrench.
 Sale \$78.69 **Tool Club \$62.95**



EXHAUST / FANS

BODY HAMMER



TA89470 9pc Body Repair Kit

Universal, toe, & heel dolly. Chisel, bumping, & door skin hammers.

General purpose and slapping spoons.
Sale \$224.94 **Tool Club \$179.95**



TA89360 5pc Body Forming Punch Set

Great for low clearance and tight areas where regular hammers do not fit. Round body, square body, bumping body, offset bumping body, & radial chisel.

Sale \$178.69 **Tool Club \$142.95**



WILM7007 7pc Body Kit

Comes in case.

Use on flat & curved surfaces.
Sale \$55.63 **Tool Club \$44.50**



LIS65800 Door Adjuster

Adjusts doors with bolted or welded hinges. Includes 2 headed pin adapter for large and small latches. Handle creates extra leverage.

Sale \$69.06 **Tool Club \$55.25**



COME-A-LONGS



LIFETIME WARRANTY

APP72A 2 Ton, 6' Lift - USA Made

Sale \$95.94 **Tool Club \$76.75**



APP18600 2 Ton, 6' Lift

New 25 year Warranty
Sale \$63.69 **Tool Club \$50.95**

APP18650 4 Ton, 6' Lift

New 25 year Warranty
Sale \$111.56 **Tool Club \$89.25**



TIT15084 7pc Autobody Hammer Set

Bumping, Pick & Finish, Reverse Curve, Utility, Double End, Shrinking and Curve Hammers.

Sale \$62.44 **Tool Club \$49.95**



DFAH714 3pc Aluminum Hammer Set

Pick & finishing hammer, curved pein & finishing hammer, and standard bumping hammer.

Sale \$237.44 **Tool Club \$189.95**



TA89900 2-3/4" x 8"

Sanding Board
Sale \$24.94

Tool Club \$19.95



TA89800 5" Sanding Block

Sale \$8.69

Tool Club \$6.95



TA89810 9" Sanding Block

Sale \$15.63

Tool Club \$12.50



MOTJO20014 2.0mm Draw Pins for Welding Stud Gun (500 Pins)

Sale \$21.88 **Tool Club \$17.50**



MOTJO1500 Magna-Spot 1500 Prof.

Stud Welder Kit

For professional collision repair technician. Includes: Magna-Spot 1500 Gun, H.D. Slide Hammer, Molded Case, 3 Electrodes, 500 2.0 mm Draw Pins & 150 Rivets.

Sale \$412.44 **Tool Club \$329.95**



MOTJO1550 Magna-Spot 1550 Deluxe Kit

Includes: Magna Spot 1550 Gun, H.D. Slide Hammer, Blow molded case, 3 Electrodes, 250 2mm drawpins, 250 2.5mm pins, 50 rivets, 5yr. Warranty, Magna Clamp & Magna T-Puller.

Sale \$562.44 **Tool Club \$449.95**



MOTJO20015 2.5mm Draw Pins for Welding Stud Gun (500 Pins)

Sale \$23.13 **Tool Club \$18.50**



EPY'S SELLS THE FULL MOCLAMP™ BODY TOOLS LINE

Call for a free catalog or price quote.



Part #	Type	Sale	Club
MCL0100	"B" Clamp	\$197.78	\$158.22
MCL0200	"C" Clamp	\$225.38	\$180.31
MCL0205	Dyna-Mo "C" Clamp	\$163.01	\$130.41
MCL0300	"JR" Clamp	\$243.34	\$194.67
MCL0400	"W" Clamp	\$467.44	\$373.95
MCL5800	"G" Clamp	\$387.44	\$309.95
MCL0405	"W" Clamp	\$194.87	\$155.90
MCL0307	Dyna-Mo 90° Corner Clamp	\$213.98	\$171.18
MCL0680	Big Mouth Clamp	\$268.69	\$214.95
MCL0800	Tac-N-Pull Set w/ Plates	\$174.94	\$139.95
MCL0805	Tac-N-Pull Plate Kit	\$98.13	\$78.50
MCL4020	4 Way Pull Clamp	\$413.13	\$330.50
MCL1000	Handy Hook	\$98.13	\$78.50
MCL1100	Handy Link	\$107.81	\$86.25
MCL1300	8" Sill Hook	\$174.06	\$139.25
MCL1800	Hook Tie-Down for Track System	\$115.94	\$92.75
MCL4021	Frame Rack Dyna-Mo #1	\$374.38	\$299.50
MCL2400	3MA Strut Multi-Adapter Plate	\$662.44	\$529.95

Part #	Size	Sale	Club
MCL6006	6' Chain	\$143.44	\$114.75
MCL6008	8' Chain	\$166.56	\$133.25
MCL6009	9' Chain	\$167.81	\$134.25
MCL6012	12' Chain	\$222.81	\$178.25
MCL6013	12' Chain w/ Alloy Slip Hook	\$230.63	\$184.50
MCL6325	Tie Down Hook Cluster	\$202.81	\$162.25
MCL1150	Chain Spread Bar	\$131.88	\$105.50
MCL6317	J Hook w/ 3/8" Chain	\$68.44	\$54.75



3/8" CHAIN

- Special proof coil chains are made specifically for body work.
- MCL6006, MCL6008, MCL6009, & MCL6012.
- Includes clevis grab hook.



TA81100
10lb Slugger In A Box
 14 parts in a metal box.
 Sale \$299.94
Tool Club \$239.95



TA81000
10lb Slugger On A Board
 The most complete set available. 16 parts total.
 Sale \$299.94
Tool Club \$239.95

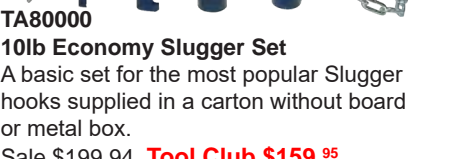

TA80000
10lb Economy Slugger Set
 A basic set for the most popular Slugger hooks supplied in a carton without board or metal box.
 Sale \$199.94 **Tool Club \$159.95**



TA81200
5lb Slap Hammer Kit
 Includes a hook & screw.
 Sale \$83.69 **Tool Club \$66.95**



TA81500
3lb Slap Hammer Kit
 Includes hook, right angle bar and screw.
 Sale \$61.19 **Tool Club \$48.95**



TA81400
3lb Slap Hammer Economy
 Sale \$49.94 **Tool Club \$39.95**

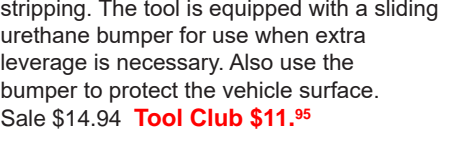

CTA1012
Mini Bulb Remover/Installer
 Scissor design for easy handling. For all types of bulbs. Cup-type ends create circular gripping area.
 Sale \$17.44 **Tool Club \$13.95**



ASTRO Pneumatic
AST4524
11pc Fastener & Molding Removal Set
 For use on internal & external vehicle molding and trim fasteners. Plastic construction of tools prevents scratching and damage to vehicle paint, leather, chrome, etc.
 Sale \$26.19 **Tool Club \$20.95**



LIS35350
Door Panel Remover
 Bent handle design for tight spaces.
 Sale \$18.13 **Tool Club \$14.50**



CAL113
5pc Trim & Panel Clip Tool Set
 Includes 5 different offsets with a range of three (3) spreads: 5mm, 7.5mm & 11mm. Ideal for plastic fasteners, plastic clips, upholstery or door panels. High-polish chrome finish & rubberized handles for additional grip.
 Sale \$46.19 **Tool Club \$36.95**



LIS81950
Molding Strip Tool
 3" wide. Sharp edge allows easy under door moldings and emblems.
 Sale \$17.81 **Tool Club \$14.25**



KDT3729
Push Pin Plier
 Removes the plastic push pins with center locking pin. No damage to pin.
 Sale \$41.19 **Tool Club \$32.95**

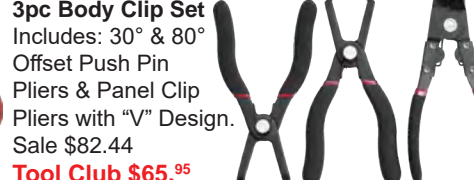

KDT41840D
2pc Push Pin Plier Set
 Straight and offset pliers
 Sale \$62.50 **Tool Club \$50.00**



KDT41850
3pc Body Clip Set
 Includes: 30° & 80° Offset Push Pin Pliers & Panel Clip Pliers with "V" Design.
 Sale \$82.44 **Tool Club \$65.95**

KDT3702D
2pc Hog Ring Plier Set
 Sale \$63.13 **Tool Club \$50.50**



TITAN
TIT15048
6pc Multi Wedge Trim Panel Tool
 Sale \$15.63
Tool Club \$12.50



ASTRO Pneumatic
AST4505
5pc Fastener & Molding Tool Set
 Variety of molding and trim fasteners. Plastic tools will protect finishes.
 Sale \$13.69 **Tool Club \$10.95**



CTA5160
Extra-Large Plastic Pry Bar
 Strong, with some flex. 400mm long
 Sale \$24.94 **Tool Club \$19.95**



LIS35400
Door Upholstery Remover
 Sale \$13.13 **Tool Club \$10.50**



LIS35260
Plastic Fastener Remover
 Sale \$16.56 **Tool Club \$13.25**



TA87810
Upholstery Clip Remover
 Sale \$12.44 **Tool Club \$9.95**

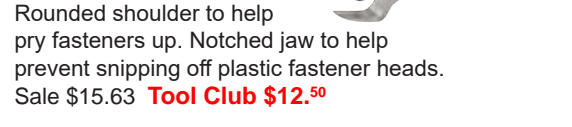

WILW5259
240pc Push Pin Retainer & Tool
 Assortment of Push Retainers for Ford, GM, Chrysler, Toyota, Honda, Nissan and more. For door trim, radiator shield yoke, fender, bumper & splash shields.
 Sale \$21.19 **Tool Club \$16.95**

GEARWRENCH

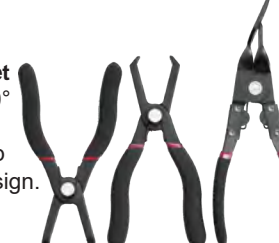



AFF819SD
20 Ton Hydraulic Body & Frame Repair Kit
 Extra capacity for the toughest jobs. Contains all the tools necessary for pushing, spreading, and pressing of vehicle body panels, parts and assemblies. Auto air bleed pump eliminates the need to bleed the system prior to use. Dual piston pump for faster lifting speeds. Double braided hydraulic hose for increased durability & resistance to cracks & abrasions. Includes 5' hydraulic hose, 20 ton hydraulic ram & 20,000 PSI Hydraulic Hand Pump.
 Sale \$1,499.94 **Tool Club \$1,199.95**

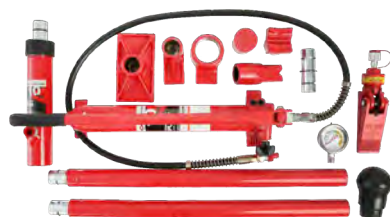

AFF817SD
10 Ton Body & Frame Repair Kit
 Contains all the tools necessary for pushing, spreading & pressing of vehicle body panels, parts and assemblies. Includes 5' Hydraulic Hose, 10 Ton Hydraulic Ram, 10 Ton Hydraulic Hand Pump & 1/2 Ton Spreader Ram.
 Sale \$624.94 **Tool Club \$499.95**



AFF58100
Viking 10 Ton Body & Frame Repair Kit
 Set includes: 58044 - 5' Hydraulic Hose
 58101 - 10 Ton Hydraulic Ram
 58102 - 10,000 PSI Hydraulic Hand Pump
 58103 - 1/2 Ton Spreader Ram
 Sale \$474.94 **Tool Club \$379.95**



AFF58040
Viking 4 Ton Body & Repair Kit
 Auto air bleed pump eliminates the need to bleed the system prior to use. Attachments are interchangeable with other body & frame kits. Set includes 5' Hydraulic Hose, 4 Ton Hydraulic Ram, 8000 PSI Hydraulic Hand Pump and 1/2 Ton Spreader Ram.
 Sale \$362.44 **Tool Club \$289.95**

PORTO POWERS

THA66040
4 Ton Collision Repair Kit
 8,200 PSI pump with 6' hose, ram with 4-3/4" stroke, 3-1/4", 5", 8-1/2", 16-1/2" and 19-1/2" extension tubes, set of attachments and case.
 Sale \$337.44 **Tool Club \$269.95**



THA66100
10 Ton Collision Repair Kit
 9,100 PSI pump with 6' hose, ram with 6" stroke, 4-5/16", 10", 18" & 26-3/4" extension tubes, set of attachments & carrying case with wheels.
 Sale \$487.44 **Tool Club \$389.95**

BH65114
4 Ton Porto Power
 Complete with 8,000PSI capacity pump with overload protection, hose, ram, 3", 6", 8-1/2", 16-1/2", & 19-1/2" extensions and set of attachments.
 Sale \$462.44 **Tool Club \$369.95**



BH65115
10 Ton PortoPower
 Complete with 10,000 PSI pump, 6ft. hose with coupler, 10 ton ram, 4", 10", 18", & 27" Extension tubes, 1/2 ton spreader & a set of attachments.
 Sale \$699.94 **Tool Club \$559.95**

SHOP VACUUMS



SVC9627106
12 Gallon 5.5 Peak HP Contractor Series Wet / Dry Vacuum with SVX2 Motor Technology
 12-foot by 1.5-inch Diameter Lock-On® Hose, Two 1.5-inch Diameter Extension Wands, 14-inch Wet/Dry Floor Nozzle, 16-inch Crevice Tool, Claw Utility Nozzle, Adaptor, Tool Storage Basket
 Sale \$249.94 **Tool Club \$199.95**

SVC5872911
5 Gallon 6.0 Peak HP Portable Wet / Dry Vacuum
 This vacuum works great to clean wet or dry messes in your garage, workshop or basement. Attach the hose to the rear blower port to blow dirt out of those hard to reach places. Limited Lifetime Warranty.
 Sale \$224.94 **Tool Club \$179.95**



SVC9627806
16 Gallon 6.5 Peak HP Stainless Steel Contractor Series Wet / Dry Vacuum with SVX2 Motor Technology
 12-foot by 1.50-inch Diameters Lock-On® Hose, Two 1.50-inch Diameter Metal Extension Wands, 14-inch Metal Nozzle, 14-inch Brush Insert, 14-inch Squeegee Insert, Tool Storage Basket. 1 Year Industrial Warranty.
 Sale \$549.94 **Tool Club \$439.95**

SVC9627306
18 Gallon 6.5 Peak HP Contractor Series Wet / Dry Vacuum with SVX2 Motor Technology
 Works great for job site cleanup, workshops, garages, basements. 1 Year Industrial Warranty.
 Sale \$187.44 **Tool Club \$149.95**

PUMPS

BH65580
3/8" Complete Coupler Set
 Sale \$63.13 **Tool Club \$50.50**



BH65581
3/8" Hose Half Coupler
 Sale \$26.88 **Tool Club \$21.50**

BH65582
3/8" Ram Half Coupler
 Sale \$41.88 **Tool Club \$33.50**

BH65291
1/4" ID - 6ft Hose w/ Male Coupler 1/4" NPTF
 Sale \$62.44
Tool Club \$49.95



BH65590
3/8" ID - 6ft Hose w/ Male Coupler 3/8" NPTF
 Sale \$112.44
Tool Club \$89.95



THA66103
10,000 PSI Air Pump
 Reservoir capacity: 103 in³
 Usable oil volume: 97.6 in³
 Input air pressure: 90-175 PSI
 Sale \$337.44 **Tool Club \$269.95**



OTC4020
Air Operated Hydraulic Foot Pump
 Delivers up to 10,000 PSI.
 Two-stage release mechanism.
 Sale \$962.44 **Tool Club \$769.95**



OTC2510A
Air Hydraulic Pump
 10,000 PSI.
 Internal relief valve.
 Foot pedal control.
 Sale \$499.94
Tool Club \$399.95



BH65425
Air Operated Hydraulic Pump
 Lightweight aluminum.
 Sale \$499.94
Tool Club \$399.95



Blackhawk Automotive

BH65426
Air Operated Foot Pump
 10,000 PSI.
 Input: 110-175 PSI.
 Mount plate included.
 Sale \$599.94
Tool Club \$479.95



BH93075
Anchor Pot
 Designed with heavy-duty protective ring at top which prevents chipping of concrete. 3-1/8" diameter.
 Sale \$99.94 **Tool Club \$79.95**



BH65454
5 Ton Pull Ram with Hooks
 Range: 11.96" - 17.48". 5.55" stroke.
 Accepts 3/8" chain links.
 Sale \$549.94 **Tool Club \$439.95**



AFF80409
10 Ton Pull Ram
 Claw hooks on each end.
 Sale \$212.44 **Tool Club \$169.95**



BH65407
10 Ton Pump, Hose & Ram Set
 Ram has 10" stroke.
 Rugged construction.
 Sale \$1,187.44
Tool Club \$949.95

10 TON



BH65139
5 Ton Flat Ram Kit
 Includes 4 stackable extensions.
 Range 1.26" to 4.9".
 Sale \$237.44
Tool Club \$189.95



RAMS

OTC4105A
10 Ton Ram w/ Half Coupler
 10-1/8" stroke.
 High strength.
 Sale \$724.94
Tool Club \$579.95



10 TON



BH65452
10 Ton Porto Power Ram
 10" stroke.
 High strength alloy steel.
 HD return springs.
 Sale \$337.44
Tool Club \$269.95

10 TON

Blackhawk Automotive



BH65444
10 Ton Threaded Ram 10" Stroke
 Range: 15.63" - 25.75".
 High strength alloy steel.
 Sale \$437.44
Tool Club \$349.95

10 TON



OTC4175
30 Ton Ram/Pump Set
 47.15 lb. 10.3 x 14.8 x 24.8 inches.
CALL FOR BEST PRICE

JAC859
10 Ton Auto Body Frame Repair Straightener with 1.2 Ton Crane, Swivel Post, 2 Air Hydraulic Pumps
 1 - Frame Assembly
 1 - Multi-Position Anchor Post
 1 - 10 Ton 6" Stroke Ram
 1 - Manual Pump
 2 - Pull Rings
 2 - Pull Clamps
 2 - 6 ft. Chains with Hooks
 2 - Support Stand
 1 - Cross-Tube
 2 - Underbody Support Clamps
CALL FOR BEST PRICE



MCL3060
Mo-Hole T-Top Tie Down for New Floors
 The pot for new construction when you really are going to be making hard pulls. Two 3" rebar legs bury themselves below the bottom of the pot for a secure anchor.
 Sale \$229.38 **Tool Club \$183.50**



JAC852B
10 Ton Auto Body Frame Straightener with 1.2 Ton Crane and Swivel Post
 1 - Frame Assembly
 1 - Multi-Position Anchor Post
 2 - 10 Ton 6" Stroke Ram
 2 - Air Hydraulic Pumps
 2 - Pull Rings
 2 - Pull Clamps
 2 - 6 ft. Chains with Hooks
 2 - Support Stand
 1 - Cross-Tube
 2 - Underbody Support Clamps
 1 - Crane
CALL FOR BEST PRICE



QUANTUM ULTRA LIGHT GUNS

All Feature:

- **High Transfer Efficiency up to 65%**
- HVLP Gravity Feed design
- Finest Atomization
- **Stainless Steel Needle & Tip**
- Unibody Head to Eliminate Leaks After Cleaning



AP Astro Pneumatic

Part #	Nozzle	Sale	Club
ASTEUROHV103	1.3mm	\$124.94	\$99.95
ASTEUROHV105	1.5mm	\$124.94	\$99.95
ASTEUROHV107	1.7mm	\$124.94	\$99.95

- HVLP Gravity Feed design
- Includes regulator and gauge
- Stainless steel needle

TITAN



Part #	Nozzle	Sale	Club
TIT19000	1.4mm	\$66.19	\$52.95
TIT19018	1.8mm	\$66.19	\$52.95
TIT19023	2.3mm	\$66.19	\$52.95

AP Astro Pneumatic

ASTEVO14
EuroPro Forged
EVO-T Spray Gun
with Plastic Cup
1.4mm Nozzle

"Air Curtain" design to minimize overspray
Lightweight: 285 grams (0.6 Lbs)
M11*P1.5 female thread fluid joint
Sale \$137.44 **Tool Club \$109.95**

NEW!



AP Astro Pneumatic

AST4008
1.8mm Spray Gun

Fully adjustable pattern control.
1 qt capacity cup.
Sale \$55.63 **Tool Club \$44.50**



TIT19302

2pc Disposable Air Line Filters

Removes moisture, oil vapor, and rust particles. Mounts at spray gun.
Sale \$9.93 **Tool Club \$7.95**



TITAN

BESTSELLER



TIT19221

4pc HVLP Gravity Feed Kit w/Case
Kit includes: 1.7, & 1.4mm guns, 1.0mm touch-up, & regulator with gauge.
Sale \$187.44 **Tool Club \$149.95**

WORK BENCHES

AST557100

Fender Extender-80" Adjustable Extension

Adjusts from 77.5" - 80" long.
Sale \$30.63 **Tool Club \$24.50**

AST557003

Portable Work Bench

500 lb capacity.
Sale \$62.44
Tool Club \$49.95



AST557005

Portable Work Bench With Sling

500 lb capacity.
Sale \$69.94
Tool Club \$55.95



POLISERS

MK9237CX3

7" Polisher

10 Amps. Includes canvas bag and 3 pads. Extra low speed for clear coat polishing. Variable speed dial and trigger maintain constant speed under load. 0-3,200 RPM.
Sale \$349.94 **Tool Club \$279.95**



DWTDW849X

7" High Performance Electronic Polisher

Controlled finishing system with soft start. Electronic controls specified speed under load. Variable speed dial: 0-3500 rpm. Wool ingestion shields on the air intake. Bale & straight handle. Weight: 6.7lbs.
Sale \$362.44 **Tool Club \$289.95**



RECIPROCATING SAWS

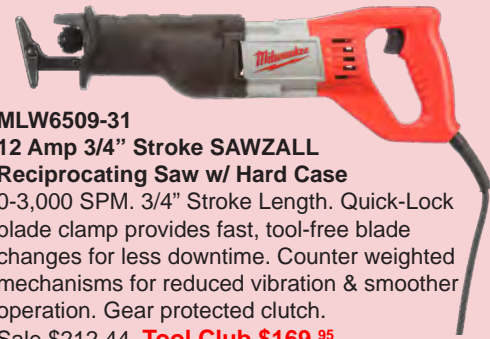

MLW6509-31

12 Amp 3/4" Stroke SAWZALL

Reciprocating Saw w/ Hard Case
0-3,000 SPM. 3/4" Stroke Length. Quick-Lock blade clamp provides fast, tool-free blade changes for less downtime. Counter weighted mechanisms for reduced vibration & smoother operation. Gear protected clutch.
Sale \$212.44 **Tool Club \$169.95**



MLW2821-20

M18™ FUEL™

Cordless Sawzall Kit Gen II (Tool-Only)

1-1/4" Stroke length. Adjustable Shoe, Keyless Blade Change. (Kits Available)
Sale \$283.69 **Tool Club \$226.95**

GRINDERS



MLW2880-20

M18 FUEL 18V Cordless 4-1/2 in. Grinder w/Paddle Switch (Tool-Only)

Adjustable Handle Position, Blade Guard System, Side Handle.
Sale \$262.44 **Tool Club \$209.95**



MLW2886-20

M18 FUEL 18V Cordless 5 in. Flathead Braking Grinder with Paddle Switch No-Lock (Tool-Only)

Sale \$374.94 **Tool Club \$299.95**



MK9557PBX1

4-1/2" Angle Grinder Kit

7.5 Amp motor. 11,000 RPM. AC/DC paddle switch for use with alternative power sources. Large paddle switch for easy operation
Sale \$137.44 **Tool Club \$109.95**

POLISERS



MLW2738-20

M18 FUEL 18V Lithium-Ion Brushless Cordless 7 in. Variable Speed Polisher (Tool-Only)

Sale \$353.13 **Tool Club \$282.50**

AIR RIVETERS

AIR THREADER

MAR39058
1/4" Heavy Duty Air/Hydraulic Riveter
 3/32", 5/32", 3/16" and 1/4" standard nosepiece
 Traction power: 3099 lbs
 recommended airline pressure is 85-95 PS
 Overall height: 12"
 Sale \$499.94
Tool Club \$399.95



ASTPR14
1/4" Air Operated Rivet Gun
 Nosepiece Sizes: 1/4", 3/16", 5/32", 1/8", & 3/32".
 • Performs well at any angle.
 • Overall length: 10-7/8".
 • Weighs only 3.5 lbs!
 Sale \$133.13
Tool Club \$106.50



Astro Pneumatic
ASTPRN1
Pneumatic Rivet Nut Setting Kit
 8pc nosepieces
 Sizes: M4, M5, M6, M8, M10, 1/4", 5/16", 3/8" 2680lbs of instant air-hydraulic pulling force
 Sale \$274.94
Tool Club \$219.95



RIVETS

TA19800
1/4" H.D. Rivet Gun
 Redesigned tool is more durable, and includes a holder for used pins.
 Sale \$62.44 **Tool Club \$49.95**



AST1426
1/4" H.D. Rivet Gun
 With holder for used pins.
 Sale \$47.19 **Tool Club \$37.75**



TA19830
1/4" H.D. Extra Long Rivet Gun
 Extra long nosepiece will reach deep into grills and other recessed areas.
 Sale \$93.69 **Tool Club \$74.95**



TA19400
Tool for Plastic Rivets
 Sets all sizes with single nosepiece.
 Sale \$31.19 **Tool Club \$24.95**



TA19200
HD Hand Riveter Kit
 Use to set 3/32", 1/8", 5/32" and 3/16" rivets.
 4 nosepieces and 40 rivets.
 Sale \$28.69 **Tool Club \$22.95**



AST1452
XL Thread Setting Riveter
 Sets extra large rivet nuts up to 1/2" & M12.
 Tool-less quick change head design.
 Includes 10pc rivet nuts.
 Sale \$124.94 **Tool Club \$99.95**



AST1442
Thread Setting Riveter
 6 interchangeable mandrel/nosepiece sets.
 Metric: M5, M6 & M8
 SAE: 10-24, 1/4-20, & 5/16-18
 Sale \$117.81 **Tool Club \$94.25**



AST1453
Combination Rivet Nut & Pop Rivet Setter Kit
 Tool-less quick change design easily transforms between pop rivet, rivet nut & nibbler functions.
 Includes attachments for blind rivet sizes in 3/32", 1/8", 5/32", 3/16" and 1/4", rivet nut attachments in M5, M6, M8, 10-24, 1/4", 5/16" & round and right-angle sheet metal nibbler.
 Sale \$117.81 **Tool Club \$94.25**



THREAD SETTERS

ASTADR14
XL Blind Rivet Adapter Kit - 1/4"
 • Easily convert your cordless, pneumatic or corded drill into a power pop riveter.
 • Includes nose pieces for 3/32", 1/8", 5/32", 3/16", 7/32" & 1/4".
 Sale \$91.56 **Tool Club \$73.25**



MAR39302
SAE Rivet Nut Thread Setter Kit
 Includes thread setter tool w/ 8-32, 10-32mm & 1/4-20 mandrels & nosepieces.
 Sale \$137.44 **Tool Club \$109.95**



MAR39303
Metric Rivet Nut Thread Setter Kit
 Includes thread setter tool w/ 4mm - 8mm mandrels & nosepieces.
 Sale \$187.44 **Tool Club \$149.95**



AST1443B
Professional SAE & Metric Hand Rivet Nut Kit
 Only 7.5" long.
 Includes rivet nut assortment and sizes M4, M5, M6, 8-32, 10-24 and 1/4-20.
 Sale \$60.63 **Tool Club \$48.50**



STEEL RIVET NUTS



Part #	Pcs.	Sizes	Sale	Club
ASTRN120	120	Assorted	\$16.88	\$13.50
ASTRN4M	100	4mm	\$7.44	\$5.95
ASTRN5M	100	5mm	\$7.44	\$5.95
ASTRN6M	100	6mm	\$8.44	\$6.75
ASTRN8M	100	8mm	\$16.19	\$12.95

TA15210
1/8" Double-Ended Drill Bits
 Tube of 10.
 Sale \$8.69 **Tool Club \$6.95**



TIT45228
Aluminum Rivets
 500pc assortment.
 Sale \$14.94
Tool Club \$11.95



WILW5250
80pc Poly Rivet Assortment
 Sale \$12.44
Tool Club \$9.95



TA18000
Spot Weld Cutter
 3/8" double ended rotary bit.
 Sale \$19.38 **Tool Club \$15.50**



RIVET ASSORTMENTS

WILW5251
120pc SAE Threaded Rivet Assortment
 Sale \$15.63
Tool Club \$12.50



WILW5252
120pc Metric Threaded Rivet Assortment
 Sale \$15.63
Tool Club \$12.50



AST1721
Spot Weld Drill Replacement Bit
 Sale \$19.38
Tool Club \$15.50



HEAVY DUTY SANDING BLOCKS

Part #	Length	Sale	Club
MOTBG12-1	12"	\$16.56	\$13.25
MOTBGR12-1	12" Rigid	\$19.06	\$15.25
MOTBGK12-1	12" Hook	\$19.06	\$15.25
MOTBGRK12-1	12" Rigid Hook	\$24.38	\$19.50
MOTBGR16-1	16" Rigid	\$28.75	\$23.00
MOTBGRK16-1	16" Rigid Hook	\$37.44	\$29.95

- Engineered from super-dense, light-weight material.
- Provide just the right amount of flex to conform to body panels and slight contours.



WINDSHIELD TOOLS

TA87460

Windshield Removal Kit

Kit contains the basic tools & wire needed for removing even the most modern windshields. Even works on acutely angled windshields. Supplied in a durable, vinyl pouch.

Sale \$59.38

Tool Club \$47.50

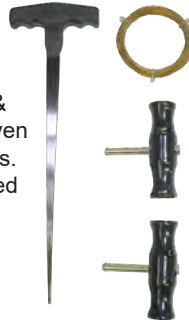

TA87890

24" Urethane Knife

Sale \$36.19

Tool Club \$28.95



TOOL AID
PROFESSIONAL AUTOMOTIVE TOOLS

TA87900

Windshield Knife

Sale \$27.44

Tool Club \$21.95



LIS63900

Suction Cup Window Holder

Sale \$22.19

Tool Club \$17.75



TA87360

Suction Cup, Lever Activated

Capacity 80 lbs.

Sale \$15.63

Tool Club \$12.50



ASTWINDKO

Windshield Remover

Astro Pneumatic

3 different blades. 20,000 oscillations per minute. Sealant cutter that cuts around bonded and encapsulated glass. Flexible blade mount can be positioned in 12 different ways (at 30° increments).

Sale \$104.94

Tool Club \$83.95



LIS35150

Window Belt Molding Remover

Fits most vehicles.

Sale \$20.94

Tool Club \$16.75



LIS35240

Belt Molding Tool

Unique design to insert under the molding at any angle.

Sale \$26.88

Tool Club \$21.50



REPLACEMENT BLADES



Part #	Sale	Club
ASTWINDK08E	\$14.38	\$11.50
ASTWINDK08H	\$19.38	\$15.50
ASTWINDK08J	\$22.44	\$17.95

TRIM CLIPS

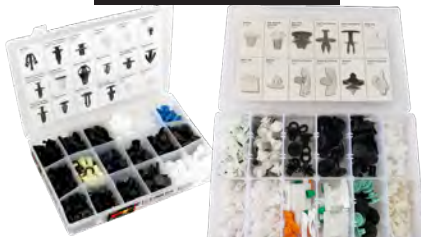

Performance Tool

Contains all essential retainer, fasteners and clips for each company. Parts are made of OEM quality nylon for OEM installation, fit, and finish. Includes convenient organizer with illustrated insert for quick part reference.

Part #	Description	Sale	Club
WILW5240	350pc - GM	\$52.44	\$41.95
WILW5241	415pc - Ford	\$37.44	\$29.95
WILW5242	215pc - Chrysler	\$33.13	\$26.50
WILW5243	340pc - Toyota	\$43.69	\$34.95
WILW5244	418pc - Honda	\$43.69	\$34.95
WILW5248	290pc - BMW	\$31.19	\$24.95
WILW5249	255pc - VW	\$32.44	\$25.95
WILW5256	160pc - Audi	\$30.63	\$24.50
WILW5257	270pc - Mercedes	\$30.63	\$24.50
WILW5258	408pc - Nissan	\$36.19	\$28.95

HEAT GUNS

TIT22400

Heat Gun Kit

Heat settings: 500° & 1000°F.

2 fan speeds: 7 & 9 CFM.

Resettable thermostat.

Sale \$34.94 **Tool Club \$27.95**



MSTEC-200K

Variable Temperature Heat Gun Kit

Range: 100°F - 930°F.

Two Fan Speeds - High and Low (5 & 9 CFM).

Built-in hand guard.

Includes tool, 7/16" air reducer attachment,

1 shrink tubing attachment,

1-15/16" & 3-1/8" spreader attachment,

1 flat metal scraper & 1 scraper handle with 3 interchangeable blades.

Sale \$90.63 **Tool Club \$72.50**



MSTHG-501D

Industrial Master "D-Series" Heat Gun

27 CFM & 3,400 FPM. Quick-change plug-in heating element. Ergonomic soft grip handle. Die cast aluminum housing.

Max temperature: 1,400°F (649°C).

Sale \$218.69 **Tool Club \$174.95**



MLW2688-21

M18™ Compact Heat Gun Kit

Reach operational temperature in 7 seconds.

Guarded nozzle.

6.4" long.

1 XC 5.0 Extended Capacity Battery, Charger,

Sale \$374.94 **Tool Club \$299.95**



MLW2688-20

M18™ Compact Heat Gun TOOL ONLY

Sale \$187.44

Tool Club \$149.95



DFDM555UDX

Ultra Ding Massager

Squeezer Puller allows for a "massaging" action that helps release tension in the metal, allowing for a quicker, more successful pull.

Includes T-Puller, Knock down tool with 2 heads (pointed and rounded), Slide Hammer, and 120V glue gun.

Sale \$624.94 **Tool Club \$499.95**



UNIDTK7700

Uni-Vac Dent Puller

Includes 3 different sized vacuum cups & case.

Self-contained vacuum feature, no airlines required. Works on steel or aluminum panels, as well as bumpers.

Sale \$299.94 **Tool Club \$239.95**



AIR BELT SANDER

 Astro Pneumatic



AST3037
Air Belt Sander
 Includes 3 sanding belts
 (40, 60 & 80 grit). 1/2" x 18" belt.
 Variable speed control.
 Sale \$135.63 **Tool Club \$108.⁵⁰**

Replacement belts come in packages of 10.

Part #	Grit	Sale	Club
AST303736	36	\$15.63	\$12. ⁵⁰
AST303740	40	\$15.63	\$12. ⁵⁰
AST303760	60	\$15.63	\$12. ⁵⁰
AST303780	80	\$15.63	\$12. ⁵⁰
AST3037100	100	\$15.63	\$12. ⁵⁰

CORDLESS SANDER





NEW!

MLW2482-20
1/2 Cordless Bandfile
 M12 FUEL 1/2 in. x 18 in.
 (Tool-Only) Spot Weld
 Removal, 2 Speed Settings
 High 3,600 SFM
 Low 1,800 SFM
 Sale \$321.88
Tool Club \$257.⁵⁰





NEW!

MLW2483-20
3/8 Cordless Bandfile
 M12 FUEL 3/8 in. x 13 in.
 (Tool-Only) Spot Weld
 Removal, 2 Speed Settings
 High 3,600 SFM
 Low 1,800 SFM
 Low 1,800 SFM
 Sale \$321.88
Tool Club \$257.⁵⁰



IR324
Pinstripe Removal Set
 3,700 RPM to remove decals, pinstripes,
 and other adhesives, without damaging paint.
 Includes (12) 4" pads.
 Sale \$187.44 **Tool Club \$149.⁹⁵**

AST400E
Smart Eraser - 4"
 5/16" - 24 thread arbor.
 Sale \$14.38 **Tool Club \$11.⁵⁰**

IR325B
Air Nibbler
 Nibbles steel,
 plastic, tin,
 aluminum &
 other metals
 up to 18 gauge
 at 6ft/min.
 Sale \$249.94 **Tool Club \$199.⁹⁵**



ACA6330
18 Gauge Nibbler
 2,500 Strokes/Minute. 3/16" Cut Radius.
 Cuts steel up to 18 gauge.
 Sale \$172.44 **Tool Club \$137.⁹⁵**



NEW!

MLW2476-20
16 Gauge Variable Speed Nibbler
 M12 Fast, Clean Cuts in 16GA Mild Steel
 Up to 7 Ft per Minute. Tool only.
 Battery charger not included.
 Sale \$299.94 **Tool Club \$239.⁹⁵**

 Astro Pneumatic

ASTDS1000
Door Skinner Tool
 Extra fast,
 with factory like
 results in one pass.
 Will roll steel flanges and
 leave the flange smooth.
 Sale \$183.69 **Tool Club \$146.⁹⁵**



ASTDS2000
Pneumatic Door Skinner Tool
 Forged and
 hardened steel de-crimping head. Precision
 machined aluminum body components,
 hardened shafts, and ball bearing construction
 throughout, for long life and maximum durability.
 Sale \$183.69 **Tool Club \$146.⁹⁵**



IR125
Air Scaler
 For removing heavy rust and scaling.
 19 needles. 4,600 blows/minute
 Sale \$261.88 **Tool Club \$209.⁵⁰**



AST4320
In-line Needle Scaler
 For scaling and rust removal. Includes
 needle scaler attachment w/ 12 steel needles.
 Sale \$124.99 **Tool Club \$99.⁹⁹**



SUNEX
 TOOLS



SUNEX8200
Surface Blaster Kit
 180° rotating handle. Remove rust, gaskets,
 paint, or pinstripes. Includes stripping wheel,
 rubber erasing wheel, hub, and 3 wire wheels.
 Sale \$432.81 **Tool Club \$346.²⁵**



KLR-ART401
Digital Aluminum / Steel Stud Welder
 Dual purpose. Welds aluminum and/or steel studs.
 110V charging system with heavy duty capacitors.
 Ready to go lever puller, T-Handle Puller, variety
 of steel and aluminum studs. 5 Year Warranty.
 Sale \$2,868.75 **Tool Club \$2,295.⁰⁰**



KLR-ART38-110
The Original Shark 110V
 Compact &
 powerful with
 20' extension cord.
 5 times faster
 than a pin welder.
 Leverage puller for power pulls.
 Comes with 3 electrodes, wiggle wire & a 6-finger
 claw. Built in USA with a 5 year warranty.
 Sale \$1,562.44 **Tool Club \$1,249.⁹⁵**



KLR-ART903M
Telescoping Tram Gauge
 Telescoping construction with quality
 anodized aluminum. Comes with 4 pointers.
 .2 - 5" + 2 graduated pointers 11", complete
 with 2 nylon storage bags. extends from
 28" to 10 feet. Accuracy within 2mm.
 Sale \$324.94 **Tool Club \$259.⁹⁵**

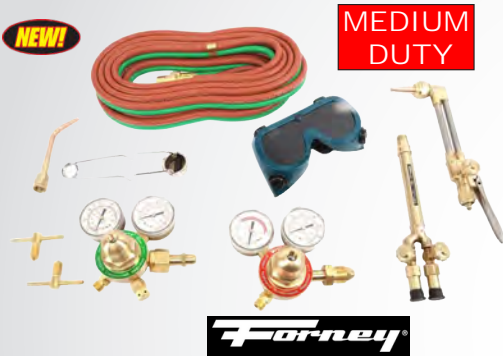

MEDIUM DUTY

FOR1705
Shop Flame Medium Duty Torch Kit
 Cuts up to 150 mm (5.91 in) & welds up to 9 mm (0.35 in) with proper tips.
 Oxygen Regulator: 250-Series (87090)
 Acetylene Regulator: 250-Series (87091)
 Torch Handle: 100FC-Series (87093)
 Cutting Attachment: 1350-Series (87092)
 Cutting Tip ,Welding Tip, Hose: 1/4 12.5ft,
 Goggles, Spark Lighter: Single Flint ,Tip Cleaner:
 Sale \$337.44 **Tool Club \$269.⁹⁵**



HEAVY DUTY

FOR1710
Shop Flame Heavy Duty Torch Kit
 Cuts up to 200 mm (7.8 in) Welds up to 12.7 mm (1/2 in) with proper tips.
 Oxygen Regulator: 350-Series (1100452)
 Acetylene Regulator: 350-Series (100449)
 Torch Handle: 315FC-Series (87102)
 Cutting Attachment: 2450-Series (87104)
 Cutting Tip, Heating Nozzle: MFA-8 (87791)
 Hose: 1/4 15ft Goggles ,Spark Lighter,
 Tip Cleaner ,Heavy-Duty Carry Case
 Sale \$524.94 **Tool Club \$419.⁹⁵**



MEDIUM DUTY

FOR1753
Tote-A-Torch Medium-Duty
 Welds up to 1/2 in (12.7 millimeters) and cuts up to 4 in (101.6 millimeters)
 Oxygen Regulator (86230)
 Acetylene Regulator (86229)
 Torch Handle (87093)
 Cutting Attachment (87092)
 Goggles,Flint Lighter,T-Grade Hose
 Cutting Tip #0.,Welding Tip #0,
 Oxygen Cylinder (86224) Acetylene Cylinder (86228) Check Valves, Plastic Tote
 Sale \$662.44 **Tool Club \$529.⁹⁵**



FOR61539
Pencil Flame Torch
 Adjustable flame knob for control and economy.
 Sale \$29.94 **Tool Club \$23.⁹⁵**



FOR70520
Scratch Brush
 10.25 inch handle with Stainless Stee bristles
 Sale \$10.63 **Tool Club \$8.⁵⁰**



FOR61545
Self-Igniting Torch
 Instant on and off trigger igniter easily ignites and extinguishes flame.
 Sale \$84.38 **Tool Club \$67.⁵⁰**



FOR86165
Welding Hose
 1/4" X 50" Welding hose
 Sale \$160.63 **Tool Club \$128.⁵⁰**



TIT41300
Welding Blanket - 4' x 6'
 Working Temperature: 1,000°F
 Protect equipment from sparks & splatters
 Sale \$34.38 **Tool Club \$27.⁵⁰**

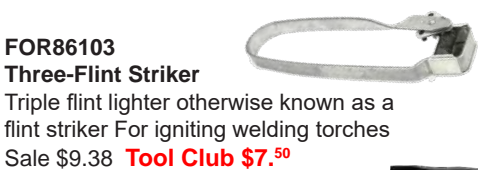

FOR86103
Three-Flint Striker
 Triple flint lighter otherwise known as a flint striker For igniting welding torches
 Sale \$9.38 **Tool Club \$7.⁵⁰**



FIR1423-0017
Fixed Front Welder's Goggles w/ Soft Frame
 Shade #5 Filter Lenses. Fits easily over corrective glasses. Hooded vents prevent fogging & offer excellent ventilation.
 Sale \$15.63 **Tool Club \$12.⁵⁰**

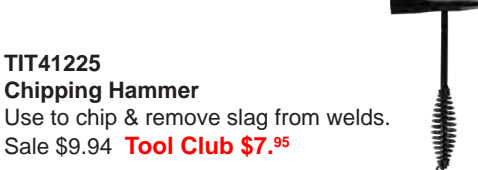

TIT41225
Chipping Hammer
 Use to chip & remove slag from welds.
 Sale \$9.94 **Tool Club \$7.⁹⁵**



TIT41217
Welding Goggles
 Anti-Scratch. Anti Fog. Perfect for light to medium work. Flexible 180° Viewing Angle.
 Sale \$19.94 **Tool Club \$15.⁹⁵**



FIR1423-0086
H.D. Cone & Chisel Chipping Hammer
 Holds up to 10lbs of 12" or 14" electrodes. Wide-blade design removes slag faster & adds to life of the tool. Spring handle.
 Sale \$12.44 **Tool Club \$9.⁹⁵**

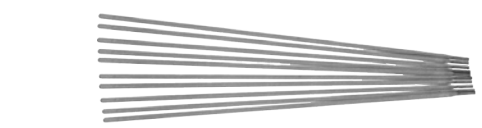

FIR1440-0096
5/32" x 5lb Mild Steel Arc Welding Electrodes
 Premium AWS Class E-6011. AC or DC, reverse polarity. All position electrode.
 Sale \$15.63 **Tool Club \$12.⁵⁰**



TIT41197
Welding Cart
 For storing & transporting most MIG & Plasma machines, shielding gas tanks & other welding equipment and accessories. Front mounted handle for easy maneuverability.
 Sale \$105.94 **Tool Club \$84.⁷⁵**

SOLDERING KITS



WELD550PK
8pc 120V Professional Soldering Gun Kit - 260/200 Watts
 Sales Price \$124.94
Tool Club \$99.⁹⁵



Rechargeable Battery!
PPPS50W
Pro-Solder 50W
 Max Temp: 1,112°F
 Running Time: 35 minutes. Charging time: 3.5hrs.
 Reaches operating temperature (536° F) in 10 seconds. 50 Watt. LED Light.
 Sale \$115.63 **Tool Club \$92.⁵⁰**

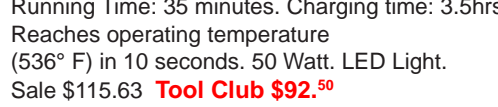

PPMTKIT01
Butane Soldering Torch Kit
 Includes PPMT torch, blower tip, heat shrink adapter shield, hot knife, soldering tip, solder attachment, rosin core solder.
 Sale \$112.44 **Tool Club \$89.⁹⁵**



PPMT
Portable Butane Torch
 Max temp 2500°F as torch and 950°F for soldering.
 Sale \$62.44 **Tool Club \$49.⁹⁵**



PPSK
Butane Soldering Torch Kit
 Tool can work as a soldering tool or as a torch. Can solder, heat shrink, and cut plastics. 2500°F torch. 950°F soldering / heating tip temp.
 Sale \$78.13 **Tool Club \$62.⁵⁰**

WELDING HELMETS

TIT41265
Solar Powered Welding Helmet (Eagle)
 Utilizes solar cells with battery backup. DIN 9 to DIN 13 as variable shade. Automatically changes from light to dark shade when arc is struck.
 Sale \$114.94 **Tool Club \$91.95**



JAC46200
Rebel ADF Welding Mask
 One-piece design protects against UV & IR leakage as well as spark & spatter penetration. Includes hood made of high-performance flame-resistant fabric. Battery lasts 1,300 hours (replaceable).
 Sale \$274.94 **Tool Club \$219.95**



JAC46240
TRANSLIGHT™ 455 Flip Premium Auto Darkening Helmet
 Switching speeds of 1/40,000 sec. ADF filter scores of 1/1/1/1 rating.
 Sale \$431.19 **Tool Club \$344.95**



JAC46250
TRANSLIGHT™555 + Premium Auto Darkening Helmet
 Switching speeds of 1/25,000 sec. ADF filter scores of 1/1/1/1 rating
 Sale \$432.44 **Tool Club \$345.95**



FLAMELESS HEAT TOOLS



IDIMD700
Mini-Ductor II
 Faster and safer than a torch. Instantly heats and removes seized nuts, bearings, and other metal without the danger of an open flame. 1,000 watt handheld induction power inverter. LED for increased vision. High frequency magnetic fields to heat only metal.
 Sale \$549.94 **Tool Club \$439.95**



IDIMDV787
Mini-Ductor™ Venom HP
 Generates Invisible Heat® to release ferrous and some non-ferrous metals from corrosion & thread lock compounds without the dangers of open flame and up to 90% faster.
 Sale \$699.94 **Tool Club \$559.95**



IDIMD99-650
Mini-Ductor™ Coil Kit
 For use with Mini-Ductor II. Enables the user to heat and release siezed nuts and bolts up to 1-1/2" in diameter and other metallic hardware from corrosion.
 Sale \$186.88 **Tool Club \$149.50**



IDIMD99-643
Mini-Ductor™ Bearing Buddy Coil Pack
 Includes: 41" & 96" Bearing Coils & (1) 6" x 12" Heat Resistant Insulator mat.
 Sale \$112.44 **Tool Club \$89.95**



LNEK2697-1
Easy Mig 140 Welder
 Welds 24 gauge to 5/16". Uses 120V input power. Aluminum spool gun ready.
 Sale \$1,062.44 **Tool Club \$849.95**

LINCOLN ELECTRIC



LNEK5257-1
Easy Mig 180 Welder
 Use 208/230V input power and weld up to 3/16" MIG and 1/2" gas-less flux-cored.
 Sale \$1,374.94 **Tool Club \$1,099.95**

MIG WELDER
 208/230V

LINCOLN ELECTRIC



LNEK5255-1
90i MIG and Flux-Cored Wire Feeder Welder with Gas Regulator
 Plugs into household 115V outlet, 30-120 Amp portable welder
 Welds up to 3/16 in. mild steel MIG
 Welds up to 1/4 in. mild steel using flux core welding wire
 Sale \$462.44 **Tool Club \$369.95**



208/230V



LNEK2535-1
Precision TIG® 225 208/230/1/60
 • Just select mode, polarity, and weld!
 • Stick welding up to 5/32" (4.0mm).
 • TIG pulser minimizes distortion.
 • 5 - 230 Amps.
 • Includes 150 amp torch with 12.5' long cable.
CALL FOR BEST PRICE

5 - 230 AMPS

LNEK2820-1
20 Plasma Cutter
 • Rated Output: 20A @ 40%, 10-15A @ 50%
 • Input Current: 20A
 • Input Power: 115/1/60
 • Cutting Capacity: 1/8" - 1/4"
 • 65 PSI @ 3.5 CFM
 • Includes cutting torch assembly with 9.5 ft. reach, ground clamp with 8 ft. cable, power cord and plug.
 Sale \$1,562.44 **Tool Club \$1,249.95**



MIG WIRE



Part #	Wire	Spool	Sale	Club
SH12000	.023"	2LB.	\$14.94	\$11.95
SH12001	.023"	11LB.	\$47.44	\$37.95
SH12003	.030"	11LB.	\$44.69	\$35.75
SH12007	.035"	33LB.	\$89.38	\$71.50

FLUX CORE WIRE



Part #	Wire	Spool	Sale	Club
SH12008	.030"	2LB.	\$27.44	\$21.95
SH12009	.035"	2LB.	\$27.44	\$21.95



FOR323
190 MP MIG Stick TIG Welder
 4-in-1 multi-process machine (MIG, Stick, Flux-Core, DC TIG) Lightweight, extremely easy to use, and a single-phase inverter machine. 120V-240V adapter cord.
 Sale \$1,874.94 **Tool Club \$1,499.95**

SHARK WELDING GLOVES

Part #	Color	Sale	Club
SH14401	Grey	\$17.44	\$13.95
SH14402	Brown	\$17.44	\$13.95
SH14404	Red	\$19.94	\$15.95



HOSE CLAMP PLIERS



AST9406



7pc Hose Plier Set

Master set will remove and install virtually every type of hose clamp. Includes 6 types of pliers plus the flexible hose clamp pliers with 24" cable. Sale \$162.44 **Tool Club \$129.95**



KDT3975D

Hose Clamp Plier

Features swivel jaws. Sale \$33.69 **Tool Club \$26.95**



LIS17460

Curved Hose Clamp Pliers

Ergonomic curved design makes pliers easy to use in hard-to-reach areas. Sale \$57.81 **Tool Club \$46.25**



LIS35070

Button Connector Pliers

Disconnects fuel line, EVAP line and DEF fittings with tabs that must be depressed to disengage. Sale \$95.31 **Tool Club \$76.25**



Hose Pinch Pliers

Self locking feature. Offset design. Used to seal vacuum, fuel line, radiator hoses, and other flexible materials.

Part #	Size	Sale	Club
LANG1460	Small	\$24.94	\$19.95
LANG1470	Medium	\$29.69	\$23.75
LANG1480	Large	\$43.69	\$34.95
LANG1500	SET	\$89.06	\$71.25



LIS44500

Small Hose Clamp Vise

Vise design fits in tight spots & is 3" long. Opens to 1-1/2". Can be tightened by hand or with a 1/4" drive ratchet. Sale \$31.88 **Tool Club \$25.50**

LIS17000

Long Reach Hose Clamp Pliers

Cross-cut tip design grips most hose clamps from multiple angles. Ratcheting lock mechanism holds the clamp in an open position for hands-free use. Dual material grips for comfort. Overall tool length of 17" provides extra long reach. Sale \$65.56 **Tool Club \$52.45**

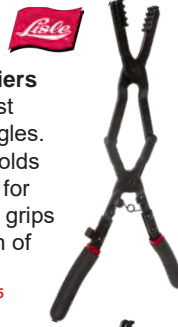

LIS17370

35° Long Hose Clamp Pliers

Provides an extra long reach & 35° angled tips for hard-to-reach hoses. Cross-cut tip design grips most hose clamps from multiple angles. Ratcheting lock mechanism holds the clamp in an open position for hands-free use. Dual material grips for comfort. Sale \$72.44 **Tool Club \$57.95**

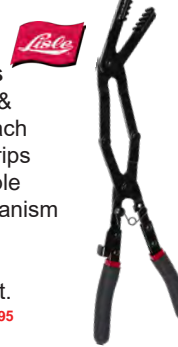

CTA1224

Locking Hose Clamp Pliers - Offset

10-1/2" Long Offset designed for removing a wide variety of hose clamps. Sale \$52.44 **Tool Club \$41.95**



CTA4029

Clic Hose Clamp Pliers

Lock and unlock Clic and Clic-R re-usable hose clamps. Sale \$29.38 **Tool Club \$23.50**



CTA1048

Large Hose Clamp Pliers

30mm circle head. Spring loaded. Opens up to 55mm. Features 30° bend. Sale \$41.88 **Tool Club \$33.50**

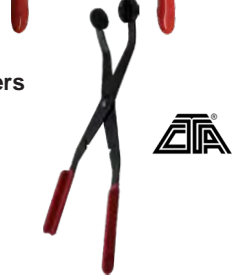

WILW83205

3pc Line Clamp Set

Built in locking mechanism. Sizes: 1/8" to 5/16", 1/2" to 3/4" & 3/4" to 2-1/2". Sale \$16.19 **Tool Club \$12.95**



LIS44480

Large Hose Clamp Vise

Vise design fits in tight spots & is 3-5/8" long. Opens to 2-1/8". Can be tightened by hand or with a 1/4" drive ratchet. Sale \$32.44 **Tool Club \$25.95**



MAY28680

Flexible Hose Clamp Plier

Clamps up to 2". H.D. cable. Pivoting jaw piece. Ratchet lock with slide guide. Sale \$104.38 **Tool Club \$83.50**



AST9409A

Flexible Hose Clamp Plier

Double gear lock lever. Large cable and strong connection. Cable adjuster and multiple gear lock. Precision clamp for extended reach. Sale \$49.94 **Tool Club \$39.95**



KDT145

Hose Pinch-Off Plier

Sale \$31.88 **Tool Club \$25.50**



LIS11420

Hose Cutter

Cuts hoses up to 1 1/4". Sale \$29.86 **Tool Club \$23.89**



LIS47900

Hose Removal Pliers

Removes vacuum and fuel hoses up to 1/2". Sale \$13.13 **Tool Club \$10.50**



LIS22850

Hose Pinchers (PAIR)

Pinch off vacuum, fuel, brake and other lines. Sale \$9.38 **Tool Club \$7.50**



LIS23000

Hose Pinchers

Clamps and holds hoses up to 3/4" I.D. Jaws are offset for hard-to-reach areas. Handles lock to hold jaws closed. Sale \$12.44 **Tool Club \$9.95**



ASTRO Pneumatic

AST78585
Radiator
Pressure
Tester &
Vacuum
Type
Cooling Kit

For domestic & import vehicles. Color coded radiator test caps. Special design of vacuum purge and refill tool fits nearly all radiator openings.

Sale \$327.44 **Tool Club \$261.⁹⁵**

AST7858523
Radiator Test Cap
Late Model Audi, VW, Porsche
Sale \$20.63 **Tool Club \$16.⁵⁰**

NEW!

AST7858541
Radiator Test Cap
Late Model GM and Ford
Sale \$20.63 **Tool Club \$16.⁵⁰**

NEW!

AST7858542
Radiator Test Cap
Late BMW and Land Rover
Sale \$20.63 **Tool Club \$16.⁵⁰**

NEW!

CTA7060
Radiator Pressure Tester
Tests automotive pressurized cooling systems up to 30 PSI. Works with adapters from CTA7057 Kit.
Sale \$137.44 **Tool Club \$109.⁹⁵**



CTA7057
10pc Radiator
Adaptor Kit - US / Asian
Includes: CTA7090, 7091, 7092, 7096, 7100, 7102, 7103, 7109, 7117, 7118.
Sale \$437.19
Tool Club \$349.⁷⁵



MITMV4560
Cooling System
Pressure Test Kit
Hand pressure pump to quickly reveal external cooling system leaks & detect internal leaks & defective caps.
Sale \$82.44 **Tool Club \$65.⁹⁵**



FJC43660
20PC
Radiator &
Radiator
Cap Pressure
Test Kit

For use in pressure testing radiator caps and radiators. For use with most domestic and import autos and light trucks.

Sale \$274.94 **Tool Club \$219.⁹⁵**

FJC43655
H.D. Cooling
System Pressure Test & Refill Kit

Designed for use with Freightliner, International, Kenworth, Peterbilt, Volvo, GMC, MACK & Sterling cooling systems. Includes Heavy Duty Vehicle adapters, pressure test regulator, vacuum refill attachment with tubing, all in a durable storage case.

Sale \$374.94 **Tool Club \$299.⁹⁵**

PL75025
Radiator Filler
3 gallon capacity
Sale \$33.69
Tool Club \$26.⁹⁵



WILW54273
Radiator Filler
2.5 gallon capacity
Sale \$29.94
Tool Club \$23.⁹⁵



AIRLIFT



UV550000
Airlift® Kit Radiator Filler
Checks for leaks in the system and makes sure it holds the vacuum. Then it refills the system with fluid and eliminates air bubbles.
Sale \$212.44 **Tool Club \$169.⁹⁵**

CTA7088
Coolant System
Filling Kit

Allows proper air bleeding. Includes 4 adapters to service most US & Asian makes, and 45° elbow.
Sale \$87.19
Tool Club \$69.⁷⁵

LIS24780
18pc Spill-Free Funnel
Includes new cap for Ford and additional straight extension.
Sale \$64.38
Tool Club \$51.⁵⁰

WILW89740
13pc Spill Proof
Coolant Funnel
Assist you with properly refilling your automotive cooling system without the chance of spilling
Sale \$24.94 **Tool Club \$19.⁹⁵**

RED95-0750
SmartFit Radiator
Adapter Set
Works on the radiators of every car or light truck. Works with any standard cooling system pressure pump.
Sale \$149.94 **Tool Club \$119.⁹⁵**



CTA PRESSURE TESTER ADAPTERS



ADAPTERS ARE COMPATIBLE WITH MOST PRESSURE TESTERS

Part #	Fits	Sale	Club
CTA7091	Asian & More	\$35.63	\$28.⁵⁰
CTA7092	Asian/Ford	\$37.44	\$29.⁹⁵
CTA7093	Audi/VW w/ male threads	\$41.88	\$33.⁵⁰
CTA7094	European	\$51.88	\$41.⁵⁰
CTA7095	VW	\$56.88	\$45.⁵⁰
CTA7096	GM/European	\$54.69	\$43.⁷⁵
CTA7097	BMW	\$66.25	\$53.⁰⁰
CTA7098	VW/Audi	\$67.81	\$54.²⁵
CTA7099	BMW	\$55.31	\$44.²⁵
CTA7100	GM/Ford/Mercedes	\$60.63	\$48.⁵⁰
MITMV4506	Universal	\$63.69	\$50.⁹⁵

SAM303141
PumpMaster 3 - 55:1 120lb Keg with 10' Hose Band Dolly
 Light weight and effective double acting high performance air operated pumps specially designed for use in mobile and portable greasing units. Pumps include a height adjustable 2" NPTM bung adapter. Pump Pressure Ratio - 55 : 1. Continuous Duty Flow Rate: 0.7 lb/min. Max Free Flow Rate: 1.2 lb/min. Max Outlet Pressure: 7,700 PSI. Air Pressure Operating Range: 20 - 140 PSI
 Sale \$1,037.44 **Tool Club \$829.95**



SAMSON

NEW!

LIS34550
Bearing Packer
 Works on bearings up to 3.5" O.D.
 Sale \$36.19
Tool Club \$28.95

LCN5900
Lever-Action Grease Coupler
 Works with all grease gun types. One handed operation.
 Sale \$46.56 **Tool Club \$37.25**



SUCTION GUNS

LCN615
18oz. Capacity
 Sale \$29.38 **Tool Club \$23.50**



MITMVA6851
7oz Fluid Extractor
 7.5" flexible tube with a non-drip car. Enables access into tight spaces.
 Sale \$37.44
Tool Club \$29.95



MITMVA6852
1.5 Liter Fluid Extractor
 16" flexible hose. Easy disassembly and cleaning. Double-seal design.
 Sale \$72.44 **Tool Club \$57.95**



TIT51884
Automotive Fluid Syringe
 For use with all types of automotive fluid. Detachable tube with cap disassembles for easy cleaning.
 Sale \$36.88 **Tool Club \$29.50**



GREASE PUMPS

LCN917
AIR OPERATED Grease Pump
 Dispenses 45oz or 80 in³ per minute at 150 PSI. Assures positive prime at lowest temperature. 43-1/8" high. 17" square base. Drum not included.
 Sale \$1,437.44
Tool Club \$1,149.95



LINCOLN

LCN6917
Air Operated Portable Grease Pump
 50:1 pneumatic pump. High pressure grease control valve. Universal swivel and coupler. 7' hose. Drum cover, flexible follower plate, and a band dolly with caster wheels.
 Sale \$1,174.94
Tool Club \$939.95



LCN1293
Hand Operated Gear Lube Pump
 Fits on any 25-50lb refinery container. Includes 5' hose.
 Sale \$108.69
Tool Club \$86.95



LINCOLN

FUEL TRANSFER

LCN1550
Fuel Transfer Pump
 360° locking bung. Quickly transfer diesel, kerosene, or mineral spirits from mobile and stationary tanks.
 Sale \$524.94 **Tool Club \$419.95**



LCN3677
25 Gallon Fuel Caddy
 2 way filter system. Dispenses or extracts fuel at a rate of 1 gallon per 12 revolutions. Easy-to read sight gauge. 7' wire reinforced hose.
 Sale \$937.44 **Tool Club \$749.95**



GREASE PUMP ACCESSORIES

LINCOLN

LCN740
Control Handle
 Works with ANY grease pump. 1/4"NPTF inlet.
 Sale \$177.81
Tool Club \$142.25

LCN81387 **Universal Joint**
 For the base of control handle.
 Sale \$110.94
Tool Club \$88.75

LCN75240 **20' Grease Hose**
 Works with ANY grease pump.
 Sale \$131.19
Tool Club \$104.95



GREASE ADAPTERS

LCN58000 **7pc Lube Adapter Kit**
 Press-on 90° lube tool, straight extension, 12" hose extension, Slide-On 90° coupler with right angle coupler, rubber tipped nozzle, needle nozzle & 360° coupler.
 Sale \$157.44 **Tool Club \$125.95**

LCN5852 **Coupler**
 For hand operated grease guns.
 Sale \$10.63 **Tool Club \$8.50**

LCN5883 **Right Angle Coupler**
 Sale \$12.44 **Tool Club \$9.95**

LCN5845 **H.D. Coupler**
 For air operated grease pumps.
 Sale \$16.88 **Tool Club \$13.50**

LCN5848 **Swivel Grease Coupler**
 Sale \$63.13 **Tool Club \$50.50**

LCN5803 **Needle Adapter**
 Sale \$18.44 **Tool Club \$14.75**



AFF8091
Extra Fine Needle Adapter
 Sale \$8.69 **Tool Club \$6.95**



FITTING CLEANERS

LCN5805
Impact Fitting Cleaner
 Clears obstructions with oil & pressure.
 Sale \$59.69
Tool Club \$47.75



DISCONNECT TOOLS

NEW!

LIS39480
13PC Aluminum Spring Disconnect Set
 Most Popular Disconnect Tools for Separating Oil Cooler Lines, Fuel Lines, Heater Lines & Air Conditioning Line Couplings
 Sale \$131.19
Tool Club \$104.⁹⁵



CTA1809
5pc Fuel Line Flex Socket Set
 Sizes: 11, 13, 14, 15 & 17mm
 Sale \$174.06
Tool Club \$139.²⁵



KDT3321
Fuel Line Disconnect
 Sizes: 5/16" & 3/8"
 Sale \$27.44
Tool Club \$21.⁹⁵



LIS39190
Heater Hose Disconnect GM 3/4"
 For heater lines on GM vehicles.
 Sale \$17.44 **Tool Club \$13.⁹⁵**



LIS39210
Main Fuel Line Disconnect
 For Toyota and Nissan.
 Sale \$24.38 **Tool Club \$19.⁵⁰**



CTA3466
BMW Disconnect Tool
 For Power Steering & Transmission lines '99 - '11 3 series & X5.
 Sale \$24.38 **Tool Club \$19.⁵⁰**



LIS39200
Heater Hose Disconnect for Ford 2.0L
 For 2012-2016 Ford Focus 2.0L & 2013-2016 Ford Escape 2.0L EcoBoost
 Sale \$9.94 **Tool Club \$7.⁹⁵**



LIS38450
STC Fitting Release Tool Set
 Sizes: 6, 8, & 10.
 Sale \$34.69
Tool Club \$27.⁷⁵



LIS22990
4pc Low Profile Jiffy-Tite Disconnect Set
 Sizes: 3/8", 1/2", 5/8" - 30%, 5/8" - 39%
 Sale \$103.13
Tool Club \$82.⁵⁰



TA19700
8pc Adjustable Fluid Line Stopper Kit
 Use to seal metal lines once disconnected. Use with all automotive fluids. Adjusts & locks to 3 positions.
 Sale \$74.94 **Tool Club \$59.⁹⁵**

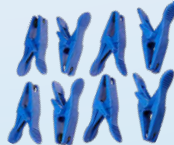

GREASE GUNS

LINCOLN

LCN1142
Manual Grease Gun
 1 oz per 33 strokes.
 21-3/4" long.
 Sale \$43.13
Tool Club \$34.⁵⁰



LCN1134
HD Pistol Grip Grease Gun
 18" flexible hose with coupler & rigid tube.
 Develops up to 7500 PSI.
 Sale \$69.38 **Tool Club \$55.⁵⁰**



LCN1133
Pistol Grip Grease Gun
 Includes 18" whip hose & coupler.
 Sale \$62.44
Tool Club \$49.⁹⁵



WILW54294
Clear View Pistol Grip Grease Gun
 Includes 12" hose with coupler.
 Develops 5,000 PSI. 3,000 PSI working pressure. 14oz capacity.
 Sale \$46.19 **Tool Club \$36.⁹⁵**

Performance Tool



AIR OPERATED

LCN1162
Air Operated Grease Gun
 Uses standard grease tube. 30" hose.
 Max PSI: 6,000. Variable speed trigger.
 Sale \$137.44 **Tool Club \$109.⁹⁵**



GREASE HOSES

Part #	Length	Sale	Club
LCN5812	12"	\$26.19	\$20.⁹⁵
LCN5818	18"	\$27.44	\$21.⁹⁵

POWERLUBER HOSES

Part #	Length	Sale	Club
LCN1230	30"	\$45.31	\$36.²⁵
LCN5861	36"	\$49.94	\$39.⁹⁵

LUB11310
14oz Ultra Lube Multi Purpose Grease
 Economical multi-purpose lithium grease for general lubrication needs.
 Sale \$8.69 **Tool Club \$6.⁹⁵**

NEW!



MLW2446-21XC
M12™ Cordless 12V Grease Gun Kit with 1 Battery.
 Powerful 12V motor delivers 8,000 PSI max operating pressure. Dispenses up to 7 cartridges per charge. Includes tool, charger, (1) M12 Battery & case.
 Sale \$337.44 **Tool Club \$269.⁹⁵**

NEW!



BATTERY OPERATED GREASE GUNS



LCN1264
12V Li-Ion PowerLuber
 Includes cordless grease gun, 2 rechargeable lithium-ion batteries, charger, and carrying case. Built-in LED light. Integrated hose holder. Air purge valve. 8,000 PSI. 30" hose. Stable 3 point stance holds the tool upright & within reach.
 Sale \$328.13 **Tool Club \$262.⁵⁰**



LCN1888
20V Li-Ion PowerLuber
 Includes cordless grease gun, 2 rechargeable lithium-ion batteries, charger, 2 extra grease couplers, & carrying case. Stable 3 point stance keeps the tool upright. Electronically controlled two-speed motor. LED indicators identify empty cartridge, loss of prime, grease output, and blocked fitting. Built-in LED light. Flow meter prevents overflow and waste.
 Sale \$459.38 **Tool Club \$367.⁵⁰**



MLW2646-22CT
M18™ Cordless 2-Speed Grease Gun Kit with 2 Batteries
 Industry leading 10,000 PSI max operating pressure. Best in class 48" flexible hose. Air Bleeder Valve. Includes M18 & M12 multi-voltage charger, 2 M18 compact REDLITHIUM™ battery.
 Sale \$499.⁹⁴ **Tool Club \$399.⁹⁵**

MLW2646-20
M18™ Cordless 2-Speed Grease Gun - TOOL ONLY
 Sale \$336.88 **Tool Club \$269.⁵⁰**

BRAKE BLEEDING

EVACUATORS



NEW!

**MITMV7840
Pressure Bleed System**

Includes a fluid dispenser with manual pump. Contains 7 master cylinder adapters. Forces new brake fluid down through the master cylinder, while air and old fluid are expelled through the bleed screw. 2-quart (2.5-liter).
Sale \$462.44 **Tool Club \$369.95**



**MITMV6835
Vacuum Brake Bleed Kit**

Same as MITMV6830. Includes MITMVA6832 Clamp-On Auto Refill Kit.
Sale \$274.94 **Tool Club \$219.95**



**CTA7015
Pressure Brake Bleeder**

Hand-operated, portable unit creates pressure to push brake fluid thru system. 3 liter capacity.
Sale \$119.94
Tool Club \$95.95



**CTA3930
11PC Brake Bleeder Adapter Set - Pro Series**

Serves Toyota, Lexus, Hyundai, Kia, Honda, Acura, Mitsubishi, Nissan, Suzuki, Mazda, Ford, Lincoln, Chevrolet, Cadillac, Buick, Chrysler, Dodge, Jeep, Ram, BMW, Land Rover, Fiat, Alfa Romeo, Volvo, Volkswagen, Audi & Porsche
Sale \$449.94 **Tool Club \$359.95**



**MITMV6838
Master Vacuum Brake Bleed Kit**

MV6830 plus MVA6836 master cylinder auto-refill kit. Variable control thumb throttle. Swivel air inlet with quick disconnect. Two refill kit styles to fit all makes and models of vehicles.
Sale \$324.94 **Tool Club \$259.95**



**MITMV8000
Automotive Tune-up & Brake Bleeding**

For one-person brake bleeding. Selectline hand vacuum pump with vacuum gauge and accessories.
Sale \$62.44 **Tool Club \$49.95**



**MIT8500
Silverline Tester Vacuum Kit**

Produces vacuum or pressure at the turn of a switch. For one-person brake bleeding. Includes variety of adapters.
Sale \$112.44 **Tool Club \$89.95**



**LUMLX1313
Manual/Pneumatic 2-in-1 Fluid Extractor**

Easy to operate. Convenient manual pump operation. Suitable for brake fluid, engine oil, gear oil, transmission fluid, water, etc. Non-spark. Non-power fluid extractor. Automatic overflow prevention. Quick-drain pour spout. 2.1L capacity.
Sale \$199.94 **Tool Club \$159.95**



**MIT7300
Fluid Evacuator & Brake Bleeder**

This 2.3 gallon tank can extract many different fluids: oil, brake fluid, coolant, etc. Includes brake bleeding adapters.
Sale \$156.19
Tool Club \$124.95



**MIT7400
Fluid Evacuator**

This 1.9 gallon tank can extract many different fluids: oil, brake fluid, coolant, etc. Use this where a drain is not available.
Sale \$112.44
Tool Club \$89.95



**MIT7201
Fluid Evacuator Plus**

This creates both a vacuum and pressure. It can evacuate and dispense a wide variety of fluids. 2.3 gallon tank.
Sale \$156.19
Tool Club \$124.95



**MITMV7412
2.5 Gallon ATF Refill Kit**

Utilizes compressed "shop-air" for dispensing and extracting. Includes adapters for most modern sealed transmissions. Conveniently located ON/OFF and flow control valve. Used fluids or overflow can be extracted by switching from pressure to vacuum. Isolated flow control and pressure/vacuum switch valves provide simple functionality control. Redundant pressure control systems safely maintain peak output pressure below 30 psi (2 bar). 2.5-gallon (10-liter) capacity reservoir. Includes flex hose with control valve and wand.
Sale \$499.94 **Tool Club \$399.95**



**CTA7300
Complete Master Cylinder Adapter Kit**

Full set of adapters (European cap, USA, & Asian) to use with CTA7015 & most other pressure brake bleeders.
Sale \$312.44 **Tool Club \$249.95**



**CTA7300M
Complete Master Cylinder Adapter Kit Updated**

Full set of adapters (European cap, USA & Asian) to use with CTA7015 & most other pressure brake bleeders.
Sale \$412.44 **Tool Club \$329.95**



LCN3639

25 Gallon Used Fluid Combo Drain

Collect used fluids including motor oil, transmission fluid, and coolant from under lift-mounted vehicles or by evacuation directly from fluid reservoirs or through dipstick tubes. Steel welded tank. Includes 6 evacuation wands of various flexibility and length. Sale \$774.38

Tool Club \$619.50

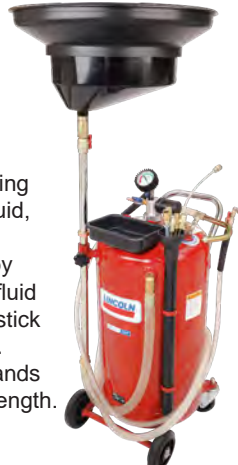

LCN3601

18 Gallon Used Oil Drain

All steel design. For use with shop air. 14" telescoping bowl adjusts 45" to 72". Reinforced dispensing hose. For draining, transferring and evacuating motor oils, transmission and power steering fluids quickly. Sale \$354.38

Tool Club \$283.50



JDI-18DC

18 Gallon Self-Evacuating Portable Oil Drain

Auto-Check Technology for easy and automatic drain evacuation. 18-gallon steel tank. 16" diameter funnel. 4-caster design providing superior stability and mobility. Oil- and chemical-resistant 3" casters for longer life. 6' discharge hose. Sale \$393.69

Tool Club \$314.95



LIS11102

8 Gallon Oil Lift Drain

This specially shaped, translucent jug holds 8 gallons. Reinforced base will not warp with hot oil. Has a wide working range from 35" to 70". Large 15" funnel has strainer built-in to catch drain plugs. Base of funnel is 1 3/4" wide. Sale \$183.68

Tool Club \$146.95



LIS19202

Low Profile Truck Oil Drain

4 rollers and handle for easy transport. Cover and curved sides to keep fluids from spilling. Only 7-1/2" high. Sale \$349.94

Tool Club \$279.95



LIS17972
4.5 Gallon Black Oval Oil Drain Pan
Sale \$27.44
Tool Club \$21.95



LIS17982
4.5 Gallon Green Oval Oil Drain Pan
Sale \$27.44
Tool Club \$21.95



WILW4071
4.5 Gallon Plastic Oil Drain Pan
Sale \$20.63
Tool Club \$16.50



LIS17922
X-Large Drainpan
30 quart pan with extended shelf.
Sale \$66.88
Tool Club \$53.50



WILW4072
X-Large Drainpan
7.5 gallon pan with extended shelf.
Sale \$41.19
Tool Club \$32.95



LIS17892
Transpan
Measures 22" x 23".
Sale \$27.81
Tool Club \$22.25



LIS17902
X-Large Transpan
38" x 24".
Fits front wheel drive transmissions.
Sale \$74.69
Tool Club \$59.75

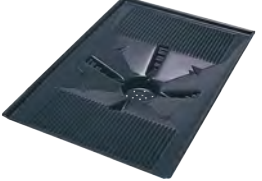

LIS19722
24" x 36" Flat Drip Pan
Sale \$45.31
Tool Club \$36.25



JDI-LP5
25 Gallon Low-Profile Oil Drain
10' quick disconnect evacuation hose. 110V electric pump. All steel construction. Expanded metal shield reduces splash. T-Handle folds for compact storage. 6" industrial casters for easy handling & transport. Long-reach T-Handle makes drain easy to position under the vehicle. Sale \$1,049.94

LCN3669
17 Gallon Electric Truck Drain
6' hose. Removable metal screen to catch debris. 120V electric pump. Pumps 1 gallon/minute. Easily positioned under high clearance vehicles. Used for motor oil, coolant, and transmission fluid. Overall height: 7-3/4". Sale \$682.44



Tool Club \$839.95

Tool Club \$545.95

LIS19822
Tire Test Tank
Sale \$89.06
Tool Club \$71.25



XTS14-956
Tire Test Tank
Sale \$91.88
Tool Club \$73.50



LIS19852
Dual Axle Wheel Pan
Fits in the rim recess.
Sale \$17.44
Tool Club \$13.95



KEN30600
Professional Super Single Axle Drain Pan
Keeps wheels & tires clean, and assures slip-free floors.
Sale \$36.88
Tool Club \$29.50



LIS38750
15" No Splatter Pad
Sale \$15.31
Tool Club \$12.25



LIS38780
22" No Splatter Pad
Sale \$31.56
Tool Club \$25.25



WILW1473
32oz H.D. Spray Bottle
Heavy duty chemical resistant sprayer bottle hold up to harsh cleaners and solvents. High output fluid nozzle that can dispense large volumes down to a light mist. Sale \$6.19

Tool Club \$4.95

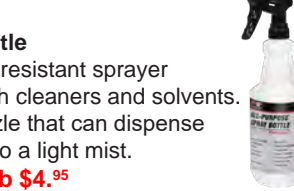

WILW1654C
Pro Anti-Freeze Tester
Precision calibrated. Color coded indicator float.
Sale \$6.56

Tool Club \$5.25

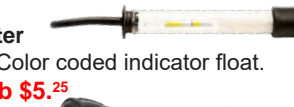

WILW1660C
Temp Comp Anti-Freeze Tester
Precise color coded glass float.
Sale \$7.50

Tool Club \$6.00

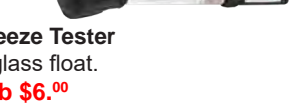

WILW1656C
Deluxe Anti-Freeze Tester
Freezing to boiling points for anti-freeze, calibrated in °C & °F.
Sale \$6.56

Tool Club \$5.25



WILW1657C
Deluxe Battery Tester
Test 6V, 12V and 24V batteries.
Sale \$6.56

Tool Club \$5.25



WILW1666C
Battery Tester
Color coded balls for easy readings.
Sale \$5.63

Tool Club \$4.50

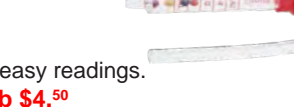

EZRSP101
Battery Hydrometer
See the state of the battery acid.
Sale \$12.44

Tool Club \$9.95



EZRSP110
DEF Hydrometer
Fast & accurate. Easy to use.
Sale \$13.69

Tool Club \$10.95





LIS58850
Oil Pan Plug
Rethreading Kit

Will accurately tap a new oversize thread.
Includes: drill, tap & 5 magnetic drain plugs.
Sale \$168.69 **Tool Club \$134.95**



LIS58650
5pc Plug & Gasket
Set for LIS58850

Sale \$33.44 **Tool Club \$26.75**



OIL/FUEL FILTER SOCKETS

LIS13270
7pc Low Profile
Filter Socket Set

6pt. 24, 25, 27, 28, 29,
32 and 36mm sockets.
Sale \$72.19

Tool Club \$57.75



LIS13300
5pc Low Profile
Filter Socket Set

6pt. 24, 27, 29, 32
and 35/36mm sockets.
Sale \$48.69

Tool Club \$38.95



LIS14500
Ford 6.0L Diesel

Fits 35mm and 36mm filters.
Sale \$12.81

Tool Club \$10.25



LIS14700
Socket for GM 2.2L

Fits 32mm filters.
Sale \$12.81

Tool Club \$10.25



LIS68210
IPR Socket for Ford Diesel

For Ford 6.0L.
Sale \$36.56

Tool Club \$29.25



CTA1037
VW/Audi Oil Drain Plug

Services 1.8L & 2.0L gas turbo
2015 & up VW & Audi vehicles
Sale Price \$12.44

Tool Club \$9.95



CTA1320
8pc Oil Drain Plug Kit

For GM, Ford, Lincoln, Chrysler, Dodge, Jeep,
Mercedes Benz, BMW, MINI, Porsche,
VW, Audi, Mazda, Volvo, Toyota & Lexus.

Sale \$91.19 **Tool Club \$72.95**



LIS40600
7pc Offset
Filter Wrench Set

Low Profile. 3/8" Drive.
6 point. Use on oil & fuel filter canisters.
Size is laser marked on each wrench.

Sale \$54.06 **Tool Club \$43.25**



OIL FILTER WRENCHES

KDT3941 Import & Fuel Filters

Range: 64mm-76mm
Sale \$27.44

Tool Club \$21.95

KDT3942 Small

Range: 73mm-83mm
Sale \$27.44

Tool Club \$21.95

KDT3943 Standard

Range: 89mm-99mm
Sale \$30.94

Tool Club \$24.75

KDT3944 Large - Truck

Range: 96mm-111mm
Sale \$31.56

Tool Club \$25.25

KDT2029DD

3/8" Drive Oil
Filter Wrench

Range: 3-7/16" - 3-3/4"
Sale \$18.44

Tool Club \$14.75

GW GEARWRENCH



LIS54300 Large For Caterpillar

Range: 5-1/4" to 5-3/4"
Sale \$19.38

Tool Club \$15.50

LIS53250 Large - Truck

Range: 4-1/8" to 4-1/2"
Sale \$14.94

Tool Club \$11.95

**LIS54200 Large -
for Cummins & Detroit Diesel**

Range: 4-5/16" to 4-3/4"
Sale \$18.13

Tool Club \$14.50

LIS53900

Straight Handle
Range: 3-1/2" to 3-7/8"
Sale \$12.44

Tool Club \$9.95

LIS54400 Import & Fuel Filters

Range: 2-3/8" to 2-5/8"
Sale \$14.06

Tool Club \$11.25

LIS53700 Small

Range: 2-7/8" to 3-1/4"
Sale \$14.94

Tool Club \$11.95

LIS53500 Standard

Range: 3-1/2" to 3-7/8"
Sale \$14.94

Tool Club \$11.95

HANDLE
SWIVELS
TO CLEAR
OBSTRUCTIONS



DISCONNECT TOOLS



LIS39850
Master Plus Disconnect Set

Most popular disconnect tools in one case.
Includes fuel line quick connect & spring lock
couplings, air conditioning line couplings, &
transmission oil cooler connectors.
Sale \$196.19 **Tool Club \$156.95**



LIS39900
Disconnect Set

Fits A/C, fuel,
heater and transmission lines.
Sale \$72.44 **Tool Club \$57.95**



LIS37000
A/C, Fuel, &
Transmission Line
Disconnect Tool

For 5/16", 3/8", 1/2",
5/8", 3/4", & 7/8" lines.
Sale \$12.44

Tool Club \$9.95



LIS39400
Angled Disconnect Set

5/16", 3/8", 1/2", 5/8", 3/4" &
7/8". Fits A/C and fuel lines.
Angled to fit in tight spaces.

Sale \$22.44 **Tool Club \$17.95**



DSIQRP4S
4pc Quick
Release
Pliers Set

Small and large angle.
Small & large vertical pliers.
Sale \$274.38 **Tool Club \$219.50**



LIS39220
3/8" & 1/2"
Disconnect Set

Sizes: 3/8" for
2003 and later Ford V8 Explorer, 2004
and later Ford F150 and Cadillac CS.
1/2" size for Ford Super Duty trucks,
F250, F350 and F450.

Sale \$31.88 **Tool Club \$25.50**



LIS39960
Transmission
Disconnect Set

Sizes: 3/8" & 1/2" for Ford Explorer,
F150, F250, F350, F450 & Cadillac CS.
Sale \$13.13 **Tool Club \$10.50**



CTA7420
Ford ATF Filler Adapter

Use with Suction Gun to fill or add
fluid to the 5R55W. Automatic
Transmission on '03 & up Ford.
Sale \$14.94 **Tool Club \$11.95**



H.D. FILTER WRENCHES

GW GEARWRENCH



Includes a 1-1/2"
wide band and a 1/2"
square drive opening.

Part #	Capacity	Sale	Club
KDT2320D	4-1/8" to 4-21/32"	\$35.63	\$28.50
KDT2321	4-21/32" to 5-5/32"	\$37.44	\$29.95
KDT2322D	5-5/32" to 5-21/32"	\$37.44	\$29.95



LIS61460
21pc H.D. End Cap Wrench Set
 84mm - 14 flutes; 76mm - 15 flutes
 93mm - 45 flutes; 82mm - 15 flutes
 80mm - 15 flutes; 76mm - 14 flutes
 93mm - 36 flutes; 86mm - 14 flutes
 96mm - 18 flutes; 76mm - 30 flutes
 100mm - 15 flutes; 74mm - 15 flutes
 90mm - 15 flutes; 73/74mm - 14 flutes
 65/67mm - 14 flutes; 74/76mm - flutes; & more!
 Sale \$168.69 **Tool Club \$134.95**

LIS61450
10pc Cap Wrench Set
 65/67mm - 14 flutes; 68mm - 14 flutes
 74/76mm - 15 flutes; 76mm - 14 / 30 flutes
 80mm - 15 flutes; 86mm - 16 flutes
 93mm - 15 / 36 flutes; 100mm - 15 flutes
 Sale \$99.69 **Tool Club \$79.75**

TOYOTA / LEXUS

CTA2460
Toyota / Lexus / Scion
 64mm x 14 Flutes.
 Sale \$20.63 **Tool Club \$16.50**



CTA2485
Toyota / Lexus
Oil Filter Wrench
 64mm x 14 Flutes.
 Sale \$12.44 **Tool Club \$9.95**



CTA2465
4-1 Oil Filter Cap Wrench
 64mm x 14 flute Fits all four
 styles of Toyota, Lexus and Scion
 Sale \$33.44 **Tool Club \$26.75**



CTA2475
Toyota / Lexus HD Steel Oil
Filter Wrench
 64mm x 14 flutes.
 Sale Price \$43.13
Tool Club \$34.50



CTA2477
Toyota / Lexus
Oil Filter Wrench
 64mm x 14 flutes.
 Slim design.
 Sale \$37.19
Tool Club \$29.75



CTA1726
Toyota Oil Filter Wrench
 64mm x 14 Flute 1/2 dr
 Sale \$31.88
Tool Club \$25.50



HYUDAI / KIA

CTA2487
Hyundai / Kia HD
Oil Filter Wrench
 88mm x 15 Flutes
 Sale \$12.44
Tool Club \$9.95



VOLVO

CTA2489
Volvo HD
Oil Filter Wrench
 86mm x 16 Flutes
 Sale \$13.44
Tool Club \$10.75



CTA2505
HD Spider Type
Oil Filter Wrench
 3/8" drive. Range: 61 - 121mm.
 Sale \$29.38
Tool Club \$23.50



CTA2507
Bi-Directional
Spider-Type Oil
Filter Wrench
 3/8" & 1/2" square drive
 & adapters w/ hex.
 Range: 50 to 95mm.
 Sale \$21.88
Tool Club \$17.50



KDT3288D
3-Jaw Adjustable
Filter Wrench
 Range 2-1/2" to 3-3/4"
 Sale \$21.88
Tool Club \$17.50



LIS63600
Adjustable Filter Wrench
 Range: 2-1/2" to 3-1/8"
 Sale \$15.63
Tool Club \$12.50



LIS63250
Adjustable Filter Wrench
 Range: 3-1/8" to 3-7/8"
 Sale \$16.56
Tool Club \$13.25



LIS60200
HD Strap Filter Wrench
 Remove or install filters &
 objects up to 6-1/2" in diameter.
 Sale \$32.81
Tool Club \$26.25



KDT3529D
H.D. Strap Wrench
 Handles filters up to 9" diameter.
 Sale \$47.44
Tool Club \$37.95



LIS28500
Strap Wrench
 Loosen or tighten any shaped
 object. Range 1" to 6-5/8"
 Sale \$30.31
Tool Club \$24.25



OIL FILTER PLIERS

VIMV2400G
Auto Adjusting
Locking Oil Filter Pliers
 Size: 8"x6"x1"
 Sale \$54.94
Tool Club \$43.95



LIS50750
Angled Oil Filter Pliers
 Range: 2-1/4" to 4" 20° offset.
 Sale \$46.19
Tool Club \$36.95



LIS50950
Large Oil Filter Pliers
 For trucks.
 Range: 3-5/8" to 6".
 Sale \$60.63
Tool Club \$48.50



CL212
12" Pliers
 Opens to 4-1/4".
 Sale \$31.88
Tool Club \$25.50



CL215
XL 15.5" Pliers
 Opens to 5-1/2".
 Sale \$37.44
Tool Club \$29.95



TIT21315
12" Strap Wrench
 36" strap.
 Sale \$21.19
Tool Club \$16.95

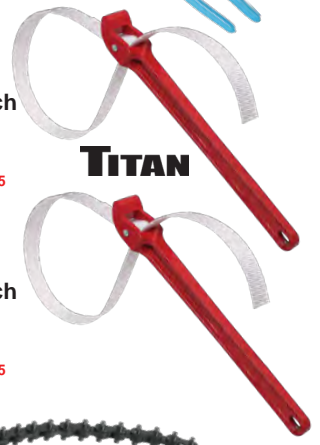

TIT21316
18" Strap Wrench
 27" Strap.
 Sale \$62.44
Tool Club \$49.95



TIT21370
12" Chain Wrench
 Pipe Capacity: 2"
 Sale \$33.13 **Tool Club \$26.50**



TIT21372
24" Chain Wrench
 Pipe Capacity: 3"
 Sale \$56.19 **Tool Club \$44.95**



CTA4326
6pc Oil Filter Wrench Set
 CTA 2538: 57mm - 73mm
 CTA2540: 65mm - 83mm
 CTA2545: 75mm - 95mm
 CTA2548: 92mm - 111mm
 CTA2552: 100mm - 120mm
 CTA2551: 120mm - 146mm
 Sale \$99.94 **Tool Club \$79.95**





MSC43050
15pc Air Powered Brake Caliper Wind Back Tool Kit
 Left or right wind-back operation. Pneumatic single piston press shaft operation allows one technician to perform the brake job.
 Sale \$217.81 **Tool Club \$174.25**

LIS25000
Disc Brake Piston Tool Set
 Includes 5 adapters for use in 2 and 4 wheel rear disc brake assemblies.
 Sale \$109.94
Tool Club \$87.95



AST78618
18pc Brake Caliper Wind Back Tool Set
 Complete set of adaptors for push & wind back brake pistons. For both left & right handed thrust bolt assemblies. Prevents damaging pistons and seals.
 Sale \$59.06
Tool Club \$47.25

BI-DIRECTIONAL



CTA1458
3 Pin Brake Piston Wind Back Adapter
 Use with 3/8" square drive tools. For use with late model VW, Audi, & BMW with Electomechanical Parking Brakes (EPB).
 Sale \$16.88 **Tool Club \$13.50**



CAL723
Brake Caliper Turn Back Tool
 Rotates brake pistons back into the caliper on vehicles with self adjusting parking brakes. Universally adjustable 2 and 3 pin.
 Sale \$64.06 **Tool Club \$51.25**



CAL724
Brake Rewind Adapter Set
 Adjustable 2 & 3 pin piston wind back tool. For vehicles with self adjusting parking brakes. Fits most vehicles.
 Sale \$48.69 **Tool Club \$38.95**



LIS81850
Brake Lining Thickness Gauge
 Checks straight & at 90° SAE: 0.0787" - 0.4724" Metric: 2mm - 12mm
 Sale \$26.88 **Tool Club \$21.50**



KDT3962
Brake Lining Thickness Gauge
 SAE: 0.0787" - 0.4720" Metric: 2mm - 12mm
 Sale \$31.56 **Tool Club \$25.25**



CTA1945
8 Pc. Brake Bleeder Wrench Set
 Bleed brakes from the drivers seat without having to open and close bleeders.
 Sale \$159.19 **Tool Club \$127.35**



VIMBB500
Brake Bleeder Wrench Set
 Sizes: 7mm - 11mm. Double bends for easy access. Angles are designed to access bleeder screws without removing the wheel.
 Sale \$64.38 **Tool Club \$51.50**



LIS10900
5/16" X 3/8" Brake Bleeder Wrench
 For 5/16" or 3/8" bleeder screws.
 Sale \$10.83 **Tool Club \$8.66**



LIS10990
7mm/9mm Brake Bleeder Wrench
 Offset for easy access to hard-to reach bleeder screws.
 Sale \$10.83 **Tool Club \$8.66**



LIS10950
Brake Bleeder 1/4 X 3/8
 For 1/4" or 3/8" bleeder screws.
 Sale \$10.83 **Tool Club \$8.66**



LIS11000
8mm/10mm Brake Bleeder Wrench
 Offset for easy access to hard-to bleeder screws
 Sale \$10.83 **Tool Club \$8.66**



CTA5077
Brake Caliper File
 Extra slim design Brake Caliper File removes residue, dust, rust and dirt from the caliper.
 Sale \$24.94 **Tool Club \$19.95**



TA17380
Disc Brake Caliper Brush
 For removal of brake dust and dirt from the caliper shaft.
 Sale \$12.44 **Tool Club \$9.95**



LIS13410
Brake Caliper Brush
 Angled HD Steel wire brush for tight spaces.
 Sale \$11.19 **Tool Club \$8.95**



LIS44210
Universal Emergency Brake Tool
 Compresses the emergency brake cable with one hand.
 Sale \$31.56 **Tool Club \$25.25**



SURBR-EZ316
110pc 3/16" Brake Line Replacement Kit
 Metric and standard fittings & 25' brake tubing
 Sale \$269.94 **Tool Club \$215.95**

SURBR-EZ14
40PC 1/4" Brake Line Replacement Kit
 Metric and standard fittings & 25' brake tubing
 Sale \$131.88 **Tool Club \$105.50**



AST7848
8pc Brake Tool Set
 Includes spring tools, adjusting spoons & mini adjusting spoon.
 Sale \$50.94 **Tool Club \$40.75**



LIS48020
Brake Caliper Hanger Set
 Hangs the disc brake caliper out of the way during service while keeping tension off the brake line.
 Sale \$11.19 **Tool Club \$8.95**

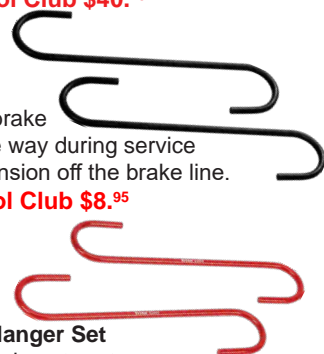

TITAN
TIT51600
Brake Caliper Hanger Set
 Securely holds exhaust systems. Made from 1/4" Heavy Duty Steel.
 Sale \$9.38 **Tool Club \$7.50**



LIS45100
Brake Spring Tool
 For return springs that don't use an anchor pin.
 Sale \$15.31 **Tool Club \$12.25**



LIS47400
Brake Spring Tool
 Fits large and small retaining washers.
 Sale \$10.63 **Tool Club \$8.50**



LIS48400
Import Brake Clip Tool
 For the hold down clips on brake shoes.
 Sale \$16.56 **Tool Club \$13.25**



LIS44800
H.D. Brake Spring Tool
 For larger return springs with or without an anchor pin.
 Sale \$20.94 **Tool Club \$16.75**



LT890
Truck Brake Spring Tool
 Slotted ends hold spring at correct work angle.
 Sale \$64.38 **Tool Club \$51.50**



BRAKE PAD SPREADERS

LANG279
Brake Caliper Press
 360° ratchet swing.
 Prevent misalignment of pistons.
 For single, dual, & quad piston calipers.
 Sale \$76.88 **Tool Club \$61.50**



LANG277
Small Brake Caliper Press
 Works on small & medium
 piston brake calipers. Size range: 1" - 3"
 Sale \$69.38 **Tool Club \$55.50**



AST78610
**Brake Caliper
 Spreader Press**
 360° ratchet swing.
 Prevent misalignment of pistons.
 For single, dual, & quad piston calipers.
 Sale \$52.44 **Tool Club \$41.95**



LIS29350
**Combination
 Disc Brake Kit**
 Designed to work on
 single piston disc brakes
 that require the piston to be
 rotated back into the caliper as
 well as pistons that are not rotated.
 Includes various adapters.
 Sale \$151.56 **Tool Club \$121.25**



LIS29100
Quick Quad Pad Spreader
 Simultaneously compress all four
 pistons on quad piston applications.
 Sale \$88.69 **Tool Club \$70.95**



LIS25750
**Dual Piston
 Brake Pad Spreader**
 Specially designed
 for dual piston calipers.
 Sale \$69.94 **Tool Club \$55.95**



LIS24300
**Speedy Brake
 Pad Spreader**
 Fast acting plunger compresses
 disc brake pistons in seconds.
 Sale \$56.88 **Tool Club \$45.50**



LIS24400
Disk Brake Pad Spreader
 Sale \$14.38 **Tool Club \$11.50**



CTA1437
**VW/Audi Brake
 Release Tool**
 Special bends allows
 separation of the brake servo push rod from the
 brake pedal. VW/Audi models 2008 and newer
 Sale \$49.94 **Tool Club \$39.95**

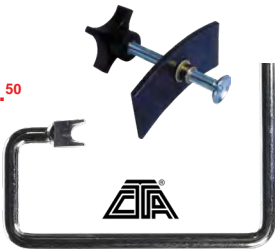

CTA5035
**5pc VAG Brake
 Caliper Socket Set**
 Services many VW/Audi group vehicles.
 Includes VAG Brake Caliper Socket 7pt. Small, 7pt. Large,
 10pt. X 11.5mm, 10pt. X 15mm & 10pt. X 20mm.
 Sale \$81.88 **Tool Club \$65.50**



MSC72485-PRC
Universal Hydraulic Flaring Tool Set
 This kit fabricates Push Connect 1/4, 5/16
 and 3/8"; GM Fuel Line Flare, Brake Lines and
 Transmission 5/16 and 3/8"; Flare/Double Flare
 3/16, 1/4, 5/16, 3/8 and 1/2"; Metric Bubble
 Flare 4.75, 6, 8, and 10mm.
 Sale \$474.94 **Tool Club \$379.95**



KDT41880D
Combination Flaring Tool
 Works on single and double flares 3/16"
 to 1/2", 6 & 10mm, plus ISO (Bubble)
 flares 4.7 to 10mm. Includes tubing cutter.
 Sale \$166.88 **Tool Club \$133.50**



KDT41870
I.S.O. Flaring Tool Set
 Forms bubble flares on
 4.75, 6, 8, & 10mm tubing.
 Sale \$109.94 **Tool Club \$87.95**



KDT41860
Double Flaring Tool Set
 Forms double flares on 3/16", 1/4",
 5/16", 3/8", 7/16", 1/2", & 5/8" tubing.
 Sale \$96.19 **Tool Club \$76.95**

TUBING TOOLS

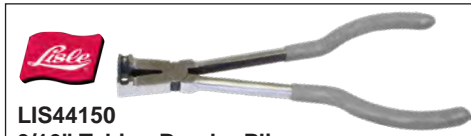

LIS44150
3/16" Tubing Bender Pliers
 For 3/16" tubing. Designed for tight spaces.
 Sale \$42.19 **Tool Club \$33.75**

LIS44070
1/4" Tubing Bending Pliers
 Bends 1/4" brake lines without
 kinking or flattening in tight spots.
 Sale \$43.13 **Tool Club \$34.50**

CTA5027
**Audi Brake Caliper
 Socket 7PT Large**
 Used for Audi S4
 and S5 Models.
 Sale \$23.13 **Tool Club \$18.50**



CTA5025
**Audi Brake Caliper
 Socket 7PT Small**
 Used for Audi Q7, S5 and
 Various Mercedes Benz models
 Sale \$23.13 **Tool Club \$18.50**



CTA7394
18pc Brake Caliper Socket Set
 Features the newest & most commonly used
 caliper sockets for most makes & models.
 Services Domestic, Euro & Asian vehicles
 Sale \$137.44 **Tool Club \$109.95**



KDT2517D
Tubing Bender
 For 3/16", 1/4", 5/16" & 3/8" OD tubing.
 Sale \$21.19 **Tool Club \$16.95**



WILW705
2-in-1 Ratcheting Pipe Cutter
 Quick release handle allows cutter to switch
 quickly from ratcheting to compact cutter.
 Adjusts to fit pipe or tubing anywhere from
 1/4"-1-1/8" (6mm-28mm).
 Sale \$36.19 **Tool Club \$28.95**

TIT11489
180° Tubing Bender
 Radius bends up to 3/8" & 180°
 max. Calibration gauge.
 Sale \$29.38 **Tool Club \$23.50**



TIT11488
Tube Bending Pliers
 For soft thin wall tubing.
 3/16", 1/4", 5/16" & 3/8"
 OD tubing.
 Sale \$20.31 **Tool Club \$16.25**



KDT2107D
Mini Tubing Cutter
 Capacity 1/8" to 5/8".
 Sale \$12.19 **Tool Club \$9.75**



TIT11490
Mini Tubing Cutter
 Capacity 1/8" to 7/8".
 Sale \$11.56
Tool Club \$9.25



TIT11491
Tubing Cutter
 Capacity 1/8" to 1-3/8".
 Sale \$35.63 **Tool Club \$28.50**



LIS19912

Multi-Application Oil Funnel - 14pc Set
Helps eliminate oil spills when refilling crankcases. 1.6 qt funnel with 14 color-coded adapters and a 45° elbow.
Sale \$78.69 **Tool Club \$62.95**



WILW1145

Multi-Use Transfer Pump
Quickly and easily transfers any fluid. Can be used as an air pump — inflation needle not included.
Sale \$16.56 **Tool Club \$13.25**



WILW1144

Deluxe Rubber Siphon Hose
All purpose Oil and gas resistant.
Sale \$6.19
Tool Club \$4.95



HAND PUMPS

ALL PUMPS FIT 30-55 GALLON DRUM

AFF8055

DEF Barrel Pump
Fits all 15-55 gallon drums. Pump can be used as a siphon. Delivers 1 pint per stroke. 2" bung adapter.
Sale \$162.44
Tool Club \$129.95



TA17580

Rotary Barrel Pump
Dispenses approx. 8 gallons per 100 revolutions.
Sale \$156.19
Tool Club \$124.95

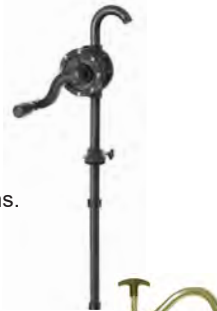

TA17550

Drum Pump for 15, 30 & 55
Dispenses approximately 1-1/2 pints per complete stroke
Sale \$62.44
Tool Club \$49.95

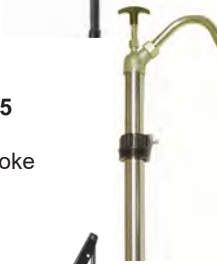

TA17560

Lever Barrel Pump
Dispenses approximately 10 oz. per stroke
Sale \$62.44
Tool Club \$49.95



AFF8050

5 Gallon Buckey Lever Pump
48" fuel-resistant PVC hose with nozzle Delivers 1 pint per stroke
Sale \$76.88
Tool Club \$61.50



LIS50240

Magnetic Funnel Holder
Holder collects residual fluids as they drain into the 12 oz. reservoir.
Sale \$29.94
Tool Club \$23.95

NEW!



WILW4069

2 pc. Universal Oil Funnel
Innovative clamp keeps funnel in position allowing the user to pour with both hands.
Sale \$19.94
Tool Club \$15.95



WILW54275

48 oz. Plastic Funnel
Sale \$4.94
Tool Club \$3.95



WILW54276

2 Quart Plastic Funnel
Sale \$4.94
Tool Club \$3.95



WILW4015

1 Pint All Purpose Funnel
Sale \$3.44
Tool Club \$2.75



WILW54272

8 qt. Steel Galvanized Funnel
Sale \$37.44
Tool Club \$29.95



WILW219

Metal Funnel 12" Flex Spout
Sale \$12.44
Tool Club \$9.95



WILW220

Plastic Funnel 18" Spout
Sale \$3.69
Tool Club \$2.95



WILW1156

3" Collapsible Funnel
Sale \$14.94
Tool Club \$11.95



WILW9167

Easy Funnel
Clips Onto Most Common Bottle Necks. (qty 1)
Sale \$3.69
Tool Club \$2.95



LIS19602

8 Qt. Low Profile Oil Dispenser
15.75" long x 7" wide x 9.5" tall
Sale \$37.44
Tool Club \$29.95

NEW!



LIS19732

6qt Oil Dispenser
With flexible 8" spout.
Sale \$24.38
Tool Club \$19.50



LIS19702

8qt Oil Dispenser With Lid And Cap
Sale \$31.56
Tool Club \$25.25



LIS17232

Right Angle Funnel
10" tall. 6-3/4" offset from center of mouth to center of spout for hard to reach areas.
Sale \$14.38
Tool Club \$11.50



LIS18232

Offset Funnel w/ Spout Cap & Lid
10" tall translucent funnel with a 6-3/4" offset
Sale \$20.31 **Tool Club \$16.25**



LIS19802

Threaded Oil / Transmission Funnel
Two piece design can be used separately or together.
Sale \$11.56
Tool Club \$9.25



WILW4034

18" Funnel
Extra long neck prevents spills.
Sale \$6.19
Tool Club \$4.95



LIS19832

1.6qt Plastic Funnel with Lid and Spout Cap
Translucent color allows you to see the fluid inside the funnel.
Sale \$18.13 **Tool Club \$14.50**



TIT19426

Refillable Aluminum Spray Bottle
CFC-free, re-usable aluminum spray bottle. Includes 55mm jet nozzle and spray nozzle. Maximum Pressure: 116PSI
Maximum capacity: 7.7oz.
Sale \$64.94 **Tool Club \$51.95**



TIT19419

Spot Spray Non-Aerosol Sprayer
80-150psi operating pressure (max pressure: 200 psi).
Maximum capacity: 32oz.
Sale \$51.19 **Tool Club \$40.95**



TIRE PRESSURE MONITORING SYSTEMS

BARTECH600PRO Tech600Pro Kit

- High resolution color display.
 - Wireless Vehicle Connection (VCI).
 - Long lasting, rechargeable battery.
 - Improved LF Signal & UHF Detection.
 - Faster tool response & operation.
 - Functions include: Wi-Fi updating, Rite-Sync®, VINDicate® & Placard Adjusting.
 - Includes 2 Year Warranty with 2 years of software updates!
- Sale \$1,618.75 **Tool Club \$1,295.00**



XTS17-43800 Smart Sensor Elite Bundle

- Features easy to navigate with icon based interface, WiFi & Bluetooth enabled, 3.5" color display, comprehensive relearn procedures built into the tool, TPMS placard adjusting, Wireless updates, VIN code scanner, capture TIN, & print TPMS & VIN/TIN data via PC. Includes Tool, Micro USB data cable & charger, OBDII Cable, 16 sensors & TPMS activation magnet.
- Sale \$618.75 **Tool Club \$495.00**



ATLITS600 Complete TPMS Service And Diagnostics Tablet

- Activates, reads and relearns all known sensors. Four MX-Sensor program modes. Batch program up to 20 MX-Sensors. Read/Erse all system codes and perform OLS, BMS, SAS and EPB.
- Sale \$624.94 **Tool Club \$499.95**



ATLTS408 TPMS Service Tool

- Easy-to-use Handheld TPMS Service tool
 - Activates all known TPMS Sensors
 - Reads sensor ID, Tire pressure, Battery Life
 - Programs MX-Sensors to replace OE Sensors
 - Free Software Updates
- Sale \$199.94 **Tool Club \$159.95**



ATLTBE200 Laser-Enabled Tire Tread and Brake Disc Wear Examiner

- 1.65" AMOLED super retina touchscreen display. Full color graphical display illustrates wear. 4MP 4cm Macro camera & 8MP zoomable camera to document tire damage. Scan TIN. 3000mAh Lithium-Ion battery.
- Sale \$487.44 **Tool Club \$389.95**



XTS17-43042 Smart Sensor Multi-Frequency TPMS Sensor

Combines 314.9MHz, 315MHz, and 433.92MHz All in ONE Sensor.
Sale \$33.69 **Tool Club \$26.95**



AUTEL ATL1SENSOR MX-SENSOR

Combines both 315MHz + 433MHz frequencies into one TPMS sensor. Weighs only 12g. Meets SAE industry standard J1205 / J1206 testing. Can be programmed wirelessly, even when already mounted to the wheel.
Sale \$36.88 **Tool Club \$29.50**



LIS19860 Tire Deflator Set

For TPMS Valve Stems. Evacuates air from tires without removing valve core.
Sale \$23.69 **Tool Club \$18.95**



LIS18810 Tire Valve Stem Torque Tool

Preset to 4 in/lb.
Sale \$33.44 **Tool Club \$26.75**



LIS14100 X-Long Valve Core Tool

Double ended, fits both large & regular valves.
Sale \$17.44 **Tool Club \$13.95**



LIS68130 Wheel Weight Tool

Sale \$36.19 **Tool Club \$28.95**

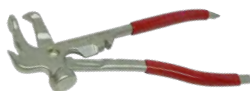

KDT3358 Wheel Weight Tool

Sale \$51.88 **Tool Club \$41.50**



LIS22800 Wheel Stud Installer

Sale \$39.38 **Tool Club \$31.50**



LIS28950 Truck Wheel Stud Installer

Fits up to 22mm (7/8").
Sale \$46.19 **Tool Club \$36.95**



PATCHES



Black vulcanizing gum blue poly backing. Designed for chemical vulcanization.

Part #	Size	Qty	Sale	Club
XTS11-306	1-3/4"	50	\$24.06	\$19.25
XTS11-308	2-1/8"	25	\$19.94	\$15.95
XTS11-310	3"	15	\$22.44	\$17.95

TIRE REPAIR



BJKT340 Professional H.D. Tire Repair Kit

T-Bone Handles with spiral probe & open eye needle, spare 4" open eye needle, screwdriver with reversible shaft & valve core tool, hex wrench, specially formulated lube, razor blade & 40 repairs.
Sale \$69.38 **Tool Club \$55.50**



AST7445 45pc Tire Repair Kit

Includes T-handle insert tool & spiral probe, (40) 4" repair strings & lubricant.
Sale \$29.38 **Tool Club \$23.50**



XTS12-353 Power-X String Tire Repair Kit - 4"

Pistol grip HD handles. Extra-thick repair inserts.
Sale \$62.44 **Tool Club \$49.95**



XTS12-354 Power-X String Tire Repair Kit - 8"

Sale \$90.63 **Tool Club \$72.50**



XTS14-219 H.D. Composite Pistol Grip Needle

Sale \$29.94 **Tool Club \$23.95**



XTS14-320 2.5" Light Duty Carbide Buffing Wheel

Sale \$8.69 **Tool Club \$6.95**



XTS14-314 3/16" x 1.5" Wood Handle Stitcher

Sale \$10.94 **Tool Club \$8.75**



BJ460 60pc Tire Repair String

4" Large Diameter
Sale \$28.75 **Tool Club \$23.00**



XTS12-361 Fat Brown String Inserts - 4" (50pk)

Sale \$10.63 **Tool Club \$8.50**

XTS12-362 Fat Brown String Inserts - 8" (50pk)

Sale \$10.63 **Tool Club \$8.50**

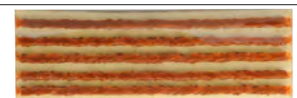

INSPECTION CAMERAS

CAL86 Dual View WiFi Borescope

Hi-Res 1080p cameras provide front and side video and image capture use mirrors to achieve alternate viewing angles
Sale \$144.38
Tool Club \$115.50



CAL84 WiFi Borescope

High resolution, multiple aspect camera (1080p, 720p & 480p). Adjustable LED lighting. Independent WiFi signal. Connect to the mobile app for both Android & iOS.
Sale \$96.56 **Tool Club \$77.25**



AUTEL



ATLMV400-55 Maxivideo™ Digital Inspection Scope

3.5" High Resolution full color LCD Display. Record & play back images & video clips. Save images & videos to internal memory or SD Card. 5x zoom. Oil & scratch resistant tempered glass camera lens. Rugged 1 meter flexible watertight camera cable. Built-in white LED. Up to 6 hours of continuous use.
Sale \$224.94 **Tool Club \$179.95**

IPA8027 6-Way Round Pin Towing Maintenance Kit

Quickly test, clean & repair truck and trailer connections. Tests tractor electrical circuits. For use with 6-way round connectors.
Sale \$41.19 **Tool Club \$32.95**



IPA8028 7-Way Flat (Spade) Pin Towing Maintenance Kit

Quickly test, clean & repair truck and trailer connections. Tests tractor electrical circuits. For use with 7-way flat (spade) connectors.
Sale \$53.44 **Tool Club \$42.75**



IPA8029 7-Way Round Pin Towing Maintenance Kit

Test, clean and restore male and female 7-way round pin connectors and terminals. For use with 7-way round connectors.
Sale \$73.13 **Tool Club \$58.50**



THERMAL IMAGING

TOP-TC001

Android Phone Thermal Imager
Turns your smartphone or computer into an infrared thermal camera. IR Resolution 256x192 Optimized Temperature Accuracy.
Sale \$262.44 **Tool Club \$209.95**



TOP-TC002

iPhone Thermal Imager
Turns your smartphone or computer into an infrared thermal camera. IR Resolution 256x192 Optimized Temperature Accuracy.
Sale \$274.94 **Tool Club \$219.95**



TOP-TC003

5.0 Inch Monitor - Thermal Imager
Durable and Resilient Thermal Camera. 4 Imaging Modes & 11 Palettes. Monitor Temperature Change by Waveform Graph. 256*192. Infrared Light Resolution Compatible with Windows Laptops. IP55 Waterproof, Records with 2gb Storage + 32gb storage Built-in 5000 mAh battery.
Sale \$456.19 **Tool Club \$364.95**



IPA9107A Electric Brake Force Meter

Dynamic load simulation & circuit testing. For use on 7-Way Flat (Spade) equipped vehicles. Meeter displays real-time brake controller output gain & timing. For use with integrated & aftermarket trailer brake controllers. Can troubleshoot truck-side tow circuits, 12V+, reverse & ground condition and the 25ft cable allows for one-man, in-cab testing.
Sale \$233.69 **Tool Club \$186.95**



IPA8048 Terminal Maintenance Set

Set cleans & repairs almost every type of electrical connectors found on cars, trucks & industrial equipment. Used as both a service & preventative maintenance tool for Deutsch, Cannon, 7 round pin trailer harnesses & more!
Sale \$157.81 **Tool Club \$126.25**



THERMOMETERS

MSC52224A Laser Infrared Thermometer

Range: -58 to 932°F. Laser targeting accuracy. Includes analog thermometer.
Sale \$86.88 **Tool Club \$69.50**



TITAN

TIT51408 High Temp Infrared Thermometer

Range: -58°F ~ 1202°F. Laser targeting accuracy.
Sale \$41.19
Tool Club \$32.95



MEMORY SAVERS

EZRMS4000 Memory Saver

Self contained unit. 12 volt, 4.5 aH sealed lead acid battery inside unit. LED indicates connection to battery circuit. Protected by a 4 amp circuit breaker.
Sale \$112.44 **Tool Club \$89.95**



LANG295A Memory Saver

Uses 9V battery (not included).
Sale \$18.13 **Tool Club \$14.50**



SOLESA30 Memory Saver

Uses 12V power port such as a booster pack
Sale \$14.94 **Tool Club \$11.95**



IPA9101 Light Ranger MUTT 7-Way Spade Pin

Portable & water resistant trailer light & brakes tester. circuit protection. Turn signal simulation & power verification LED. 500mA battery charger & 3-Way trailer adapter included. Internal battery compartment (battery not included). For 7-way spade, 6-way round & 4/5 pin trailer harnesses.
Sale \$233.69 **Tool Club \$186.95**



IPA9102 Heavy Ranger MUTT® 7-Way Round Pin

Commercial Trailer light and brakes tester. Short circuit protection. Water resistant. Turn signal & power verification LED. Internal battery compartment (battery not included). External 12V power port. Includes 500 mA battery charger.
Sale \$233.69 **Tool Club \$186.95**





**PP319FTC
POWERPROBE3 Tester**

With a built-in voltmeter. Works with all systems up to 42 volt. Built-in banana jack for accessories. Kit included & adapters. Sale \$174.94 **Tool Club \$139.95**



**PP3CS
POWERPROBE 3 Circuit Tester - TOOL ONLY**

Supplies Power & Ground. Digital Voltmeter with Min/Max Voltage Capturing. 4mm banana jack. 20 Foot power lead. Tests for Bad Grounds and Continuity. 8 Amp Circuit Breaker Protection. Sale \$143.69 **Tool Club \$114.95**



**PP3EZ
POWERPROBE 3EZ Kit**

Test voltages and power up components on and off the vehicle. EZ Learning software, teaches the user how to operate the tool. EZ Diagnostics software, teaches the user how to perform common diagnostic applications on a vehicle. Menu driven navigation. Packaged in case with a cigarette adapter and a 20 ft. extension cord. Sale \$201.88 **Tool Club \$161.50**



**PP3EZCS
POWERPROBE 3EZ Tool Only**

Test voltages and power up components on and off the vehicle. EZ Learning software, teaches the user how to operate the tool. EZ Diagnostics software, teaches the user how to perform common diagnostic applications on a vehicle. Menu driven navigation. Sale \$174.94 **Tool Club \$139.95**



**PPIV
POWERPROBE 4**

Larger & brighter color screen. Easy resistance testing. 001 OHMS - 100K OHMS accuracy. Load test circuits. Circuit health check. 23' power lead for long reach. 4mm Banana Jack for optional accessories. 50MS testing AC & DC. Min/Max voltage / reading capture. Sale \$281.88 **Tool Club \$225.50**

POWER PROBE®

**PPKIT03S
POWERPROBE3 MASTER KIT**

- Includes:**
- PowerProbe 3 Tester
 - ECT3000 Short Circuit Finder
 - PPLS01 Test Lead Set
- Features:**
- Power Up Components
 - Audio Tone Voltmeter
 - 12 - 24 Volt Range
 - 20ft. Jumper Lead Set
 - Bad Ground Indicator
 - Continuity Tester
 - Short Circuit Indicator
 - Relay and Component Tester
- Sale \$374.94
Tool Club \$299.95



**PPKIT04
POWERPROBE IV
MASTER COMBO KIT
SAVE TIME AND MONEY
WITH AN ALL IN ONE KIT!!**

- Includes:**
- PowerProbe IV Tester
 - ECT3000 Short Circuit Finder
 - PPLS01 Test Lead Set
- Sale \$437.44
Tool Club \$349.95



**PPTM01AS
POWERPROBE Maestro Kit**

- Includes:**
- 2.2" color LCD
 - EZ Learning
 - Guided diagnostic screens
- Includes:**
- PowerProbe Maestro unit w/ 23ft Power Lead
 - 4" Probe Tip
 - Alligator Clip Adapter
 - Battery Clip Set
- Sale \$362.44
Tool Club \$289.95



**PP3LS01
POWERPROBE3
Lead Set Kit**

- Includes:**
- PP319FTC, cigarette lighter adapter, 3" probe tip, battery hook-up clips, 20' extension cable, alligator clip adapter, 1', 3' and 6' leads, male & female adapters, piercing probes.
- Sale \$249.94
Tool Club \$199.95



**PPECT3000
Short / Open Circuit Tracer**

- Identify and locate shorts or open circuits in the wiring.
 - Includes bulb adapters, back probe, blade probe, piercing probe, alligator clip, universal banana plug lead with 4mm plug.
 - Automatic and manual sensitivity locking.
 - Arrow indicates direction to short.
 - Signal Distance indicator bar.
 - 10 minute auto shut off.
 - Ergonomic housing.
- Sale \$212.44
Tool Club \$169.95





TA18650 Deutsch Terminal Service Kit
Includes terminal release tools and crimpers for Deutsch terminals.
Sale \$174.94 **Tool Club \$139.95**



LIS69300 Master Relay and Fused Circuit Test Kit
Includes 8 Jumpers to fit most popular relays, Test Lead Kit & Terminal Leads. Allows testing of relay configurations not covered by our eight Relay Test Jumpers, Like Volkswagen, BMW and other European vehicles.
*Relay Puller Pliers easily remove electrical relays.
Sale \$249.38 **Tool Club \$199.50**



WILW89732 23pc Terminal Release Kit
Contains terminal release tools for most domestic, European and Japanese cars and trucks. Application reference chart.
Sale \$157.44 **Tool Club \$125.95**

TA18700 11pc SAE 12-22 AWG Service Deutsch Terminal Crimper Set
Use with Deutsch, Weather Pack, Metri Pack and Molex terminals. Color coded aluminum handles. Comes in a blow-molded carrying case with each tool identified in the case.
Sale \$281.19 **Tool Club \$224.95**



IPA8016 Fuse Saver Master Kit
Resettable breaker handles for use on any circuit. Quick disconnect for on-the-spot repairs. BuzzAlert provides an audible alert when the circuit triggers. Includes 5, 10, 15, 20 and 30 amp breaker handles. Packaged in a blow molded case.
Sale \$274.94 **Tool Club \$219.95**



CTA9812 26pc Terminal Tool Kit
For both import & domestic vehicles. Made with high quality steel. Includes application chart with a cross reference for terminal brands.
Sale \$162.44 **Tool Club \$129.95**

TA18550 Deutsch Terminal Release Tools
Ranges: 14-16, 16-18, 20-24. All metal construction.
Sale \$51.56 **Tool Club \$41.25**



ES190 Relay Buddy Automotive Relay Tester
Tests 4/5 Pin Relays - 3 different relay types. Quick and easy "off the car" relay test. Tester uses 12V battery from vehicle, cycles the relay 10 times.
Sale \$75.44 **Tool Club \$60.35**



WILW9053 22pc Terminal Release Kit
Contains styles and sizes to fit most domestic and imported cars, trucks, motorcycles, computer wiring harnesses and power supply connector plugs.
Sale \$28.13 **Tool Club \$22.50**

CTA2246 7pc Deutsch Terminal Tool Kit
Includes 7 of the most popular sizes: 5.6mm, 4.6mm, 4.1mm, 4.0mm, 2.9mm(x2) & 1.8mm. Used for servicing Deutsch terminals. Comes in a hook and loop closure pouch.
Sale \$78.69 **Tool Club \$62.95**



ES195 Super Relay Buddy® Pro Kit
7+ amp load to the relay and looks for excessive voltage drops. Settable to 4 and 5-pin relays. test 10 different relays
Sale \$212.44 **Tool Club \$169.95**

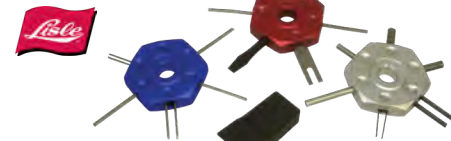

LIS7750 Wire Terminal Tool Kit
Works on conventional, Pack-Con, Weather Pack terminals and many GM vehicles. Blue tool fits many Ford applications.
Sale \$63.69 **Tool Club \$50.95**

ES309A Fuse Buddy Mini Kit
Tests all three fuse sizes: Micro, Mini, and ATO circuits. Can be used on circuits up to 30 Amps
Sale \$49.94 **Tool Club \$39.95**



LIS46950 Relay Puller Pliers
For most domestic & import vehicles.
Sale \$23.69 **Tool Club \$18.95**



LIS13120 Electrical Connector Tool
For Weather-Pack and other terminals.
Sale \$12.44 **Tool Club \$9.95**

ES316 Relay Fuse Buddy
In-circuit bypass switch controls power downstream of the relay. 20 Amps continuous 30 Amps momentary.
Sale \$87.44 **Tool Club \$69.95**



IPA9038A Relay Bypass Switch Master Kit with Amp Loop
Controls relay circuit with "On/Off" switch to test the amps.
Sale \$127.81 **Tool Club \$102.25**



ES125 Digital Tach Advance Timing Light
Sale \$116.19 **Tool Club \$92.95**





AST9478
220pc Weather Pack Interchangeable Ratcheting Crimping Tool Kit
 For assembling and crimping a wide range of the most common Delphi Weather Pack Connectors. 216 pieces of accessories.
 Sale \$124.94 **Tool Club \$99.95**

TIT11950
7pc Ratcheting Terminal Wire Crimping Set
 6 interchangeable dies.
 Quick-change jaw. Built-in safety release.
 Sale \$145.63 **Tool Club \$116.50**



TA18900
Ratcheting Terminal Crimper
 Crimps 10 - 22 gauge insulated terminals.
 Sale \$37.44 **Tool Club \$29.95**



CL958G
6" Wire Stripper
 Sale \$18.69 **Tool Club \$14.95**



CL909G
H.D. 9-3/4" Crimping Pliers
 Sale \$30.94 **Tool Club \$24.75**



CL911G
9-1/2" Cable Cutter
 Sale \$38.44 **Tool Club \$30.75**



CL968
7.5" Forged Wire Stripper
 Sale \$52.81 **Tool Club \$42.25**



TIT11476
Mini Electrical Plier Set
 Includes cutter, stripper, and crimper.
 Sale \$37.44 **Tool Club \$29.95**



WILW202
2-in-1 Wire Stripper / Crimper
 Changes from wire stripper to crimper.
 Sale \$28.75 **Tool Club \$23.00**



LIS57850
Battery Carrier
 Sale \$19.94 **Tool Club \$15.95**



LIS68280
Compact Wire Stripper
 8 to 14 gauge wires.
 Sale \$36.56 **Tool Club \$29.25**



LIS68250
Compact Wire Stripper
 14 to 24 gauge wires.
 Sale \$36.56 **Tool Club \$29.25**



TA19100
Wire Stripper for Recessed Areas
 Strips & cuts 12-22 gauge single or multiple stranded conductor wire.
 Sale \$27.44 **Tool Club \$21.95**



TA18950
Automatic Wire Stripper
 Strips, crimps & cuts 10 - 26 gauge wire.
 Sale \$24.69 **Tool Club \$19.75**



TA19000
Automatic Wire Stripper
 Strips, crimps, and cuts 10 - 26 gauge wire.
 Sale \$27.81 **Tool Club \$22.25**



TIT11475
Self Adjusting Wire Stripper, Crimper & Cutter
 For 10 - 24 gauge wire.
 Sale \$30.63 **Tool Club \$24.50**



TIT11478
Wire Stripper
 Cuts solid AWG 8 to 20 and stranded wire 8 to 22 gauge.
 Sale \$19.69 **Tool Club \$15.75**



WILW200
Automatic Wire Strippers
 For 8 - 18 gauge wire.
 Sale \$17.44 **Tool Club \$13.95**



TIT11400
9" Pistol Grip Needle Nose Pliers / Crimper
 Ergonomic pistol grip for more power and less fatigue. Perfect for hard to reach areas. Built-in wire cutter and crimper.
 Sale \$13.13 **Tool Club \$10.50**

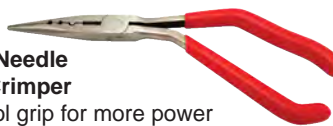

EZRPG5
5-in-1 Pistol Grip Pliers
 10" long nose pliers with crimping, cutting, wire stripping, and fastener extraction functions. Offset jaws and ergonomic pistol grip.
 Sale \$40.31 **Tool Club \$32.25**



LIS11120
Battery Brush
 Plastic Case
 Sale \$10.43 **Tool Club \$8.35**



KDT201D
Battery Brush
 Plastic case
 Sale \$10.63 **Tool Club \$8.50**



EZRBMK1914
7pc Battery Maintenance Kit
 Two sets of pliers, 3 wrench sizes, puller, cable & post cleaner.
 Sale \$74.94 **Tool Club \$59.95**



EZRB795
Heavy Duty Crimping Tool
 Exerts equal pressure on all contact points. 50 different crimp settings. No dies to replace or misalign. 6 gauge through approximately 5/8" cable.
 Sale \$174.06 **Tool Club \$139.25**

EZRB7946
3 Point Crimper For Battery Terminals
 Sale \$82.44
Tool Club \$65.95



LIS54150
H.D. Terminal Puller
 Sale \$33.44
Tool Club \$26.75



TIT11981
H.D. Cable Crimper
 Powerful hydraulic action delivers force of 10 tons. Includes 8 dies. 17.5" Long.
 Sale \$104.38 **Tool Club \$83.50**

KDT3367
5/16" Ratcheting Side Terminal Wrench
 Sale \$19.94 **Tool Club \$15.95**



EZRBCK18
H.D. Battery Cable Repair Kit
 All the tools needed to repair, build and create battery terminal cables - on or off the vehicle. This set of heavy duty tools can be used with a pneumatic driver or ratchet as well as the included breaker bar. Making precise cuts and crimps has never been easier. Strip the jackets with the precision stripper for a neat and secure connection.
 Sale \$189.69 **Tool Club \$151.75**



**ES146
54pc Automotive
Test Connectors**

Allows connection to most automotive vehicle connectors, foreign and domestic. Connects easily to most DMM's and scopes. Includes 48" stacked banana plug test leads. Sale \$159.38 **Tool Club \$127.50**



**ES147
18pc Micro 64
Test Connector Kit**

Variety of terminal adapters which enable connection to Micro64 terminals. Sale \$120.63 **Tool Club \$96.50**



**ES142
PRO Test Lead Kit**

Includes: Set of Interconnect Leads (64"), Test probes, Flexible Silicon Back Probe Pins, Wire Piercing Clips, HD Insulation Piercing Clips, Crocodile Clips & Deluxe Storage Pouch. Sale \$91.56 **Tool Club \$73.25**



TEST LEADS

**CTA7662
92pc Master Line Kit**
Comprehensive electrical & electrical testing kit for cars, trucks, tractors, ATVs, Motorcycles, boats & more. 1000V & 30 Amps plus CE certified. Safety covers for sharp probe tips. Sale \$305.63 **Tool Club \$244.50**



**TA23500
20pc Back Probe Kit**
Use to back probe harness connectors, fuel injectors and automotive sensors. Straight, 45 degree & 90 degree stainless steel probes in .027" and .040" diameters. Color coded for easy identification. Compatible with standard 4mm plug. Sale \$30.31 **Tool Club \$24.25**



**TA21200
Clamp Probe Set**
Handsfree operation is a useful diagnostic tool when a third hand is needed. Sale \$43.69 **Tool Club \$34.95**



**RETRACTABLE
TEST LEADS**



Part #	Leads	Sale	Club
LANG1129	3 x 10'	\$24.94	\$19.95
LANG1135	3 x 10' Magnetic	\$34.38	\$27.50
LANG1137	2 x 30'	\$47.19	\$37.75
LANG1138	2 x 30' Magnetic	\$49.94	\$39.95
LANG1176	2 x 15' w/ Adapters	\$74.38	\$59.50

**ES804
EZ Test™ 10pc
Back Probe Kit**

Designed for backprobing, diagnostic testing & electrical troubleshooting. Sale \$46.56 **Tool Club \$37.25**

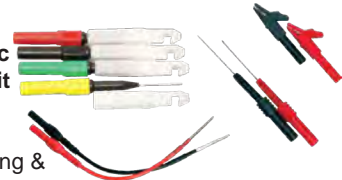

**LIS64900
17pc Back Probe & Alligator Clip Set**
Good for all test leads. Sale \$62.44 **Tool Club \$49.95**



TEST LIGHTS

**LIS32150
Power & Ground Outlet**
Provides a convenient ground and power source. Sale \$23.13 **Tool Club \$18.50**



**LIS32900
HD Circuit Tester & Jumper**
Test circuits up to 12 volts and works as a jumper wire for power or ground. Sale \$32.81 **Tool Club \$26.25**



**LIS29050
Digital Circuit Tester 3-30v**
360° visibility of polarity. 47" cord with heavy duty alligator clip. Insulated probe. Sale \$56.88 **Tool Club \$45.50**



**LIS28830
Digital Circuit Tester 3-49v**
Digital LCD display accurately shows DC voltage. Red and green lights for positive and negative polarity. 12' coil cord. Sale \$91.88 **Tool Club \$73.50**



**TIT11436
Digital Circuit Tester 6-48v**
Blacklit LED provides a "no guess" voltage value of the circuit. Surge protected circuitry. Sale \$28.44 **Tool Club \$22.75**



**TA27250
X-Long
Circuit Tester**
For 6 & 12 volt testing. 12' retractable cable. 6-1/2" long probe. Sale \$21.88 **Tool Club \$17.50**



**TA28100
Automotive
Logic Probe**
Computer safe. For systems up to 24V. LED glows red for power (+) and green for ground (-). 6' long wire. Sale \$21.19 **Tool Club \$16.95**



**TA27000
H. D. Circuit Tester**
For 6 & 12 volt systems. 5' tough, flexible, & insulated rubber wire. Sale \$10.63 **Tool Club \$8.50**



**TA27300
Circuit Tester**
For 6 & 12 volt systems. 12' retractable wire. 3-1/4" probe. Sale \$16.88 **Tool Club \$13.50**



WERA TOOLS



**WERA05020013001
11pc Joker Metric Combination Wrench-Set**
Sizes: 8mm- 19mm. 12pt Ratcheting combination wrenches. Sale \$337.44 **Tool Club \$269.95**



**WERA05051024001
17pc Interchangeable Tip Screw Driver**
Slotted, Phillips, Square, Torx, Hex, Security Torx Tip Types Included. Sale \$47.44 **Tool Club \$37.95**

**WERA05073230001
1/4 Bit Ratchet**
Suitable for direct take-up of bits with 1/4" hex head drive. Sale \$40.63 **Tool Club \$32.50**



**WERA05073260001
1/4 Roto Head Ratchet**
Sale \$87.44 **Tool Club \$69.95**



**WERA05073261001
3/8 Roto Head Ratchet**
Sale \$99.94 **Tool Club \$79.95**

MULTIMETERS



FLK88-5AKIT Multimeter Kit

Includes: 88V Multimeter, test leads, alligator clips, test probes, inductive RPM pickup, temp. probe, backprobe pins, insulation piercing probe, holster & 9V battery. Built-in thermometer. Magnetic hanger for easy set up. Large, backlit display. Sale \$1,124.94 **Tool Club \$899.95**



ES585K Multimeter & Engine Analyzer

Features: Volt, Inductive Amps, Ohms, Temp, Tach, Hz, Dwell, Duty Cycle, Continuity, Diode Test & AC/DC. Sale \$131.19 **Tool Club \$104.95**



ES480A Multimeter

Features: Volt, Amps, Ohms, Tach, Hz, Dwell, Duty Cycle, Capacitance, Continuity, Autoranging & AC/DC. Sale \$49.94 **Tool Club \$39.95**



ES385A Multimeter

Includes: DC Volt, DC Amps, Ohms, Tach, Hz, Dwell, Duty Cycle, Diode & Continuity. Sale \$49.94 **Tool Club \$39.95**

FLK115 Field Technicians Digital Multimeter

Compact True-rms digital multimeter for field service. Includes: meter, holster, 4 mm silicone test lead set. Easy one-handed operation of the meter. Min/Max/Average to record signal fluctuations. Sale \$374.94 **Tool Club \$299.95**



FLK117 Electrician's Multimeter w/ Non-Contact Voltage

Compact, true-rms digital multimeter for electricians. Includes multimeter, 4mm silicone test leads, holster and manual. Integrated non-contact voltage detection. Selectable low-impedance mode. Sale \$412.44 **Tool Club \$329.95**



FLK88-5 Deluxe Automotive Multimeter

Pulse width, duty cycle, Min/Max/Avg recording. 10 meg ohm input impedance won't damage computer circuits. Large display and bright backlight for increased visibility. Can measure voltage up to 1000 V AC and DC, current up to 10 A, 20 A for up to 30 seconds and frequency to 200 kHz and % duty cycle. Sale \$824.94 **Tool Club \$659.95**



EV / HYBRID

ES550 EV Insulation Tester

Checks high voltage circuits on EV's and Hybrids for leaks to ground. It can supply 250V, 500V and 1000V test voltages for doing complete insulation testing. Sale \$274.94 **Tool Club \$219.95**



OSCILLOSCOPE

LANG13805 Automotive Scope / Graphing DMM

- Sample Rate: 20 mega-samples.
- 48 pre-set waveforms that include: sensor, actuator, electrical, and ignition patterns.
- DC to 5 MHz bandwidth.
- "Glitch Snare" made captures display
- Dimensions: 12.5" x 15.5" x 4.5"
- Sweep Rate: 1 μ S to 50 seconds in Scope Mode

Sale \$1,312.44 **Tool Club \$1,049.95**



EV RESCUE

EV RESCUE 5K

Power station delivers reliable, instant power whenever and wherever you need it. Ideal for towing companies Looking to charge electric vehicles dead on the side of the road or Mobile technicians needing consistent Voltage power supply, using clean, renewable power - no fumes, no noise and no excessive costs. Simply flip the switch for silent, emissions-free portable power. The EV RESCUE 5k can also be used to complement or completely replace gas/diesel.

AC Output:
120 VAC pure sine wave (THD <3%)
60Hz, single phase, 40A Max continuous
Charging Times (0 to 90% SOC)
1x AC input (120VAC, 1,200W): 5 hours
2x2 AC input (120VAC 2,400W): 2.5 hours
Combined input (AC + Solar): 1.5 hours
Output Connectors
1x125VAC, 20A weatherproof receptacle (NEMA 5-20R)
1x125/250 VAC 20A receptacle (NEMA L14-20R)
2 x 5VDC, 2.4A USB receptacles generators.

CALL FOR BEST PRICE!

RESCUES EV'S
WHEN OUT OF
POWER!



NEW!

TOPDON 111

MULTIMETERS / INSULATED TOOLS



**ES688
True RMS Low
Current Clamp Meter**
Larger clamp size (19mm).
True RMS accuracy.
Great for parasitic drain testing.
Accurate to 1 mA.
Sale \$312.44
Tool Club \$249.95



**ES655
High Current Probe/DMM**
For all high current apps, especially starting and charging diagnostics. Up to 1000 Amps AC or DC. 37 Test Ranges & 10 Test Functions. Sale \$224.94 **Tool Club \$179.95**



**ES333
Dual Mode Tachometer**
Laser mode:
Detects up to 6 ft. away.
Contact mode:
with interchangeable tips.
Sale \$137.44
Tool Club \$109.95

MIDTRONICS

MIDPBT300 Professional Battery Tester

Measurement range from 100 - 1400 CCA. Green & Red LEDs give fast decisions on starter and charging system testing. Bad cell detection & high/low voltage capture for improved testing. Sale \$393.69 **Tool Club \$314.95**



MIDMDXP300 Battery & Electrical System Analyzer

Tests 12 volt batteries & systems for cars and light trucks and displays results. Tests lead-acid, AGM, and GEL batteries. Integrated printer with a customizable header on printout. Sale \$812.44 **Tool Club \$649.95**



MIDCPX900 12V Battery & Electrical System Analyzer

3.5" color display. On-Tool Wi-Fi & Bluetooth capabilities. Supports conventional lead-acid, AGM, Gel and EFB (enchanced flooded batteries). Sale \$1,499.94 **Tool Club \$1,199.95**



MIDMDX650PSOH Battery & Electrical System Analyzer

Tests lead-acid, AGM, EFB, and Gel batteries 100-2000 CCA. Detects bad-cells. New (State-of-Health) graph helps interpret test results. Intermediate starter and alternator test. Built-in printer. 10' field/replaceable cables, larger clamps open wider, new protective rubber boot. Sale \$1,224.94 **Tool Club \$979.95**



ASO12-1015 Battery & Electrical System Analyzer With Printer

Lightweight hand-held digital battery tester with Thermo Printer and USB port. Stores last test series with or without power. For testing all 12V automotive starting batteries rated in CCA, SAE, DIN, JIS#, IEC, EN and CA. Also for testing vehicle's Electrical System. Carrying case and cables included. Sale \$514.94 **Tool Club \$411.95**



ATLBT608 MaxiBAS Battery & Electrical System Diagnostics Tool

Support in-vehicle and out-of-vehicle testing. Test 6 & 12 V batteries. Test 12 & 24 V cranking/charging systems. Test Flooded, AGM, AGM Spiral, EFB & GEL batteries. Sale \$624.94 **Tool Club \$499.95**



TOP-BT300P 12/24V Battery & Electrical System Tester

Tests 12V batteries. Tests 12V/24V vehicle electronic systems. Tests lead-acid batteries, flooded, AGM, Gel & EFB. Includes built-in printer to print test results within seconds! Spark-free copper clamps, PVC-coated wiring, and built-in automatic protection against reverse polarity. Sale \$124.94 **Tool Club \$99.95**



FLASHING POWER SUPPLY



TOP-TORNADO9000 TORNADO9000 12/24V Smart Battery Charger

Output current: 12V 5-90A; 24V 5-45A. 6 charging modes, with adjustable current & voltage. ECU Programming voltage stabilizer. Can act as a stable power supply for various automotive appliances such as tire inflators, car fridges & more! 9-Step Smart Charging eliminates overcharging. Multi-Protection System. For batteries 20-2800Ah. Sale \$812.44 **Tool Club \$649.95**



ASOESS610 Reflash Power Supply & Heavy Duty Battery Charger - 12V/120A

Charged 12V lead acid and lithium (LFP) batteries from 5 to 1500 Ah. 8-step charging for lead and 9-step charging for LFP lithium. Supports up to 100A for 12V batteries in vehicles in the diagnostic phase and in maintenance workshops. Allows you to check a vehicle's battery voltage, evaluate the starting system, and the condition of the alternator. Recovers deeply discharged batteries greater than 2V (automatic SOS recovery). 120V Power Supply. Sale \$1,674.94 **Tool Club \$1,339.95**

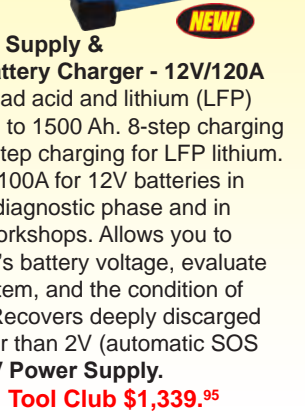

BATTERY TESTERS, 6/12 VOLT BATTERIES, ALTERNATORS & STARTERS.

- One hand operation.
- Easy to read meter.
- Recessed meter/insulated clamps.

ASO6029 6/12V Battery Load Tester

125 Amp Load. 0-16V DC. Sale \$168.69 **Tool Club \$134.95**



ASO6031 6/12V "Pro" Battery Load Tester

Includes cable for GM diode trios. 125 Amp Load. 0-16V. Sale \$212.44 **Tool Club \$169.95**



OTC3182 130 Amp Digital Battery Load Tester

Tests 6 & 12V batteries. 0-16 volt range. Sale \$119.38 **Tool Club \$95.50**



SOLBA9 40-1200 CCA 12V Digital Battery & System Tester

4.5-16V operating range. 40-1200 CCA testing capacity. Tests multiple battery types. Tests to CCA, CA, DIN, EN, IEC standards. Small, portable and pocket-sized. Sale \$71.88 **Tool Club \$57.50**



ES710 500 Amp Battery Load Tester

Tests batteries, alternators, starters and regulators. Sale \$149.94 **Tool Club \$119.95**



ES706 Digital Load Tester

Automatic tester. No guessing how long to apply the load. Sale \$74.94 **Tool Club \$59.95**



ES700 100 Amp Battery Tester

Internal load capacity: 100 amps. Tests battery voltage, relative starter current with heat protection draw, charging voltage, and battery condition. H.D. cable clamps. Sale \$49.94 **Tool Club \$39.95**



ASSOCIATED

MADE IN USA
BATTERY CHARGERS

"SAFE IN ANY WEATHER" OPERATION



6/12V

ASOUS20
6/12 Volt
40 Amp Charger
200 Amp Cranking Assist.
330 Amps Manufacturer's
Boost Rating.
90 minute timer with HOLD.
For small shop owner and DIY.
Sale \$437.44
Tool Club \$349.95



6/12V

ASO6009AGM
6/12 Volt H.D. Fast Charger
Continuous ratings: 70/60/2 Amp;
Boost rating: 540AUL
Cranking assist rating: 265A
A.C. cord: 6-1/2/16-3.
DC leads: 7' / 4AWG
Clamp Rating: 500A.
Weight 48 lbs.
Transformer/rectifier
limited warranty-5 Years
New 2 Year Bumper to
Bumper Warranty.
AGM Charging Supported!
Sale \$812.44 **Tool Club \$649.95**



SOLAR. NEW!

PRO-LOGIX

SOLPL3740
40/15/5/225A 12V
Intelligent Wheel Charger
with Engine Start
AUTO and HOLD
charge modes
Timed charge modes
Properly charges Flooded,
AGM, Spiral Wound, Deep
Cycle and Marine batteries
PS Mode at 3 preset values
(13.4V, 13.7V, 14.1V)
Sale \$374.94 **Tool Club \$299.95**



SOLAR. PRO-LOGIX

SOLPL3760
60/40/10/250A 12/24V
Intelligent Wheeled
Charger w/ Engine Start
12/24 Volt charging and
maintaining.
60<->40/40/10A 12V
charging rates.
20/10A 24V charging rates
Fully automatic,
multi-phase charging
process. Charges multiple
lead acid battery types.
Forced start allows charging
of totally dead batteries
Sale \$562.44 **Tool Club \$449.95**



BATTERY CHARGERS



6/12V

ASO6001A
6/12 Volt H.D.
Battery Charger
Highest performance
fast charger on the market.
75 Amp continuous charge
with 375 Amp crank assist.
Rugged 7" tires.
625 Amp boost.
Sale \$1,099.94
Tool Club \$879.95



6/12V
18/24V

ASO6006AGM
6/12/24 Volt H.D.
Commercial Fleet Charger
This heavy-duty fleet
chargers 6/12/24V
batteries with five charging
positions. UL continuous
rating: 70/65/30 Amp;
UL cranking assist
rating: 280 Amp.
AGM Charging Supported!
Sale \$874.94
Tool Club \$699.95



6/12V
18/24V

ASO6002B
6/12/18/24 Volt
H.D. Commercial
Battery Charger
Highest performance
fleet charger on the
market. Rated up to
80 Amp continuous
charge with 400 Amp
crank assist at 12v.
725 Amp boost rating.
Sale \$1,249.94
Tool Club \$999.95



12V

ASOIBC6008MSK
12V Digital Intellamatic
Battery Charger
Micro-processor controlled
and fully automatic.
Electrical Stability System
(ESS™) technology.
Nominal 13.7V DC Output
Memory Saver Mode.
15A Continuous/20A Peak
Patented diagnostics
indicate weak or
defective batteries.
Charges all types of 12V batteries.
Designed for AGM, Gel Cell, Sealed,
and Standard Flooded batteries including
Spiral Cell, Orbital™, or Optima™ batteries.
Dead Battery Override control.
"Safe In Any Weather" Operation.
Reverse polarity protected.
5 Amp 12' Straight Cable with OBDII Connector
Sale \$1,412.44 **Tool Club \$1,129.95**



ASO6010B
H.D. Commercial
Portable Battery Charger
Charges all standard
and maintenance free
6/12/24 volt batteries
with 4 charging
positions. 120 minute
automatic timer.
Stop/go-light
technology.
500 Amp clamps.
Sale \$774.94
Tool Club \$619.95



6/12/24V



PRO-LOGIX

SOLPL2410
2/6/10 Amp
Battery Charger
Advanced multi-phase
charging process.
For 12 & 24 volt batteries.
Sale \$178.69
Tool Club \$142.95



SOLPL2320
20/10/2 Amp
Battery Charger
Advanced multi-phase
charging process.
For 6 & 12 volt batteries.
Sale \$142.44
Tool Club \$113.95



SOLPL2310
10/6/2 Amp
Battery Charger
Advanced multi-phase
charging process.
For 6 & 12 volt batteries.
Sale \$112.44
Tool Club \$89.95



TOP-T4000
Tornado4000 4-Amp
Fully Automatic
Battery Charger
Charges 6V & 12V
lead-acid batteries &
12V lithium-ion batteries.
Compatible with regular
flooded, AGM, GEL, &
deep-cycle batteries.
Reverse polarity protection.
Revolutionary 9-step charging allows for faster
charging and better battery maintenance.
Sale \$59.38 **Tool Club \$47.50**



ASO9002A
1.5 Amp Auto Charger
Can be mounted in vehicle.
Shuts down automatically
Sale \$65.63
Tool Club \$52.50



MULTIPLE BATTERY CHARGERS

SOLAR. PRO-LOGIX

SOLPL4020
4 Bank Charger
4 independent
charging channels.
2 amp output per channel.
For flooded & AGM batteries.
Sale \$212.44 **Tool Club \$169.95**



BATTERY CHARGERS

TOPDON



TOP-JS1200
Jump Surge 1200
1200W Portable
Battery Jumpstarter
 10,000 mAh capacity. 1,200 peak amps.
 25 jump starts on a full charge.
 Boost function revives dead or damaged batteries! Innovative Stop Spark™ sensors.
 300 Lumens flashlight. Usb quick charge 3.0 Port. Sturdy outer housing is resistant to water, dust, and wear.
 Sale \$124.94 **Tool Club \$99.95**

TOPDON



TOP-JS2000
Jump Surge 2000
2000A Portable
Battery Jumpstarter
 16,000 mAh capacity. 2,000 peak amps.
 35 jump starts on a full charge.
 Boost function revives dead or damaged batteries! Innovative Stop Spark™ sensors.
 300 Lumens flashlight. Usb quick charge 3.0 Port. Sturdy outer housing is resistant to water, dust, and wear.
 Sale \$143.69 **Tool Club \$114.95**

TOPDON



TOP-JS3000
Jump Surge 3000
3000A Portable
Battery Jumpstarter
 24,000 mAh capacity. 3,000 peak amps.
 45 jump starts on a full charge. Boost function revives dead or damaged batteries! Revive up to 9L gas vehicles & 7L diesel vehicles. Innovative Stop Spark™ sensors. 400 Lumens flashlight. Usb quick charge 3.0 Port. Sturdy outer housing is resistant to water, dust, and wear.
 Sale \$249.94 **Tool Club \$199.95**



TOP-H200
Hurricano200 Portable
Lithium Power Station
 49,800mAh Battery Capacity.
 Provides 200W total power output and works on any device that consumes under 200W.
 Power upto 7 devices at once!
 Sale \$174.94 **Tool Club \$139.95**

CAL590 BOOST ULTRA



Portable Jump Starter & Battery Pack
 800 cold cranking amps.
 4,000 peak amps.
 30,000mAh battery.
 Professional grade power can jump start large diesels and high-compression gasoline engines!
 Sale \$317.44 **Tool Club \$253.95**



NOCGB014
Boost HD EVA Protection Case for GB70
 Carrying handle. Rugged zipper. Rugged storage
 Sale \$37.44 **Tool Club \$29.95**
NOCGB015
Boost HD EVA Protection Case for GB150
 Carrying handle. Rugged zipper. Rugged storage
 Sale \$43.69 **Tool Club \$34.95**



NOCGB40
1,000 Amp
UltraSafe Lithium Jump Starter
 Spark-proof connections and reverse polarity protection. Recharges USB devices. LED flashlight. Jump starts gas engines up to 6 liters, and diesel up to 3 liters. Provides up to 20 jump starts on a single charge.
 Sale \$137.44 **Tool Club \$109.95**



NOCGB70
2,000 Amp
UltraSafe Lithium Jump Starter
 Spark-proof connections & reverse polarity protection. Recharges USB devices. LED flashlight. Jump starts gas engines up to 8 liters, & diesel engines up to 6 liters. Provides up to 40 jump starts on a single charge.
 Sale \$274.94 **Tool Club \$219.95**



NOCGB150
3,000 Amp UltraSafe Lithium Jump Starter
 Spark-proof connections and reverse polarity protection. Recharges USB devices. LED flashlight. Jump starts both gas & diesel engines up to 10 liters and more. Provides up to 80 jump starts on a single charge.
 Sale \$412.44 **Tool Club \$329.95**



NOCGBX155
4250 Amp UltraSafe Lithium Jump Starter
 Spark-proof connections and reverse polarity protection. Recharges USB devices. LED flashlight. Jump starts both gas & diesel engines up to 10 liters and more. Provides up to 80 jump starts on a single charge.
 Sale \$437.44 **Tool Club \$349.95**

NOCO



NOCGB251
24V 3000 Amp
UltraSafe Lithium Jump Starter
 Spark-proof connections and reverse polarity protection. Recharges USB devices. LED flashlight. Jump starts both gas & diesel engines 6, 8, 12, and 16 cylinder. Plus, an integrated digital battery voltmeter for enhanced diagnostics. Protection EVA Case, and 1-Year Limited Warranty.
 Sale \$1,312.44 **Tool Club \$1,049.95**



NOCGB500
20,000 Amp 12/24V Lithium Jump Starter
 12V and 24V lithium jump starter rated at 20,000 Amps, 80,000 Joules3S (10,000 Amps, 40,000 Joules3S in 24V). Patented safety protection with spark-proof technology and reverse polarity protection that allows it to connect to any battery safely. 12-volt power from anywhere. Designed for both gas and diesel engines up to Class 8+/CE high-displacement vehicles, equipment, trucks.
 Sale \$2,187.44 **Tool Club \$1,749.95**



KKJNC660
12v Portable Jump Starter
Peak Amps: 1700.
Cranking Amps: 425.
Built-in charger - charges with any extension cord. Voltmeter for charge status of onboard battery. 12v DC outlet.
Sale \$199.94 **Tool Club \$159.95**



KKJNCAIR
12v Portable Jump Starter with Air Compressor
Peak Amps: 1700
Cranking Amps: 425
68" cables. Includes 12' coiled air hose with screw on chuck. Automatic charging.
Sale \$324.94 **Tool Club \$259.95**



KKJNC1224
12 & 24 Volt Jump Starter
46" cables. Built-in automatic charger. 12v DC outlet. Voltmeter for on-board battery status.
12v: Peak Amps (3400) Cranking Amps (850)
24v: Peak Amps (1700) Cranking Amps (425)
Sale \$574.94 **Tool Club \$459.95**



KKJNC770R
Premium 12v Portable Jump Starter
Extra long 68" cables. PowerJaw clamps for maximum power transfer and durability. Peak Amps: 1700. Cranking Amps: 425. Dual USB outlets & high intensity LED task light. 12v DC outlet for accessories.
Sale \$237.44 **Tool Club \$189.95**



SOLES5000
12v Booster Pac
Peak Amps: 1500. Cranking Amps: 400. Automatic recharging. LED battery status indicator. 43" cables. DC outlet to power 12v accessories.
Sale \$199.94 **Tool Club \$159.95**



SOLES1224
12 & 24 Volt Booster Pac
Switches voltages with the switch of a knob. 60" cables. Automatic recharging.
12v: Peak Amps (3000) Cranking Amps (750)
24v: Peak Amps (1500) Cranking Amps (370)
Sale \$587.44 **Tool Club \$469.95**



KKJNC950
12v HD Portable Jump Starter
Peak Amps: 2000. Cranking Amps: 925. 46" cables. Built-on automatic charger. Voltmeter provides charge status of on-board battery. 12v DC outlet.
Sale \$437.44 **Tool Club \$349.95**



SOLES6000
H.D. Booster Pac
Peak Amps: 3,000. Cranking Amps: 800
54" cables. 12v DC outlet. Automatic charging.
Sale \$437.44 **Tool Club \$349.95**



HEAVY DUTY BOOSTER PAC



SOLHT1224AGM
12/24V Commercial Charger/Starter
• 10' jumper cables.
• 12v - 1400 CCA.
• 24v - 800 CCA.
• Automatic 7 amp x 2 channel battery charging system.
• Includes (2) Group 31 AGM batteries.
• Weight: 189 lbs.
• Perfect for dealerships and used car lots!
Sale \$2,499.94 **Tool Club \$1,999.95**

BOOSTER CABLES

1 & 2 Gauge cables come with a carrying case.



Part #	Wire Gauge	Amp Rating	Clamp Length	Club
FJC45233	4	600	16ft.	\$49.95
FJC45244	2	600	20ft.	\$69.95
FJC45255	1	800	25ft. HD	\$123.95

REPLACEMENT CLAMPS



ASO6202	500	\$43.95
ASO6205	800	\$51.50
FJC45262	600	\$10.95

POWER INVERTERS

SOLPI10000X
1000W Dual Outlet Power Inverter

1000W continuous power. 2000W peak power. (2) 110VAC Outlets. Overload/overheat protection.
Sale \$199.94 **Tool Club \$159.95**



SOLPI20000X
2000W Triple Outlet Power Inverter

2000W continuous power. 4000W peak power. (3) 110VAC Outlets. Power display showing input voltage and output wattage for easy power demand management.
Sale \$399.94 **Tool Club \$319.95**



SOLPI15000X
1500W Triple Outlet Power Inverter

1500W continuous power. 3000W peak power. (3) 110VAC Outlets. Power display showing input voltage and output wattage for easy power demand management.
Sale \$362.44 **Tool Club \$289.95**



SOLPI30000X
3000W Triple Outlet Power Inverter w/ Junction Box

3000w continuous power. 6000W peak power. (3) 110VAC Outlets; (1) junction block connection. Power display showing input voltage and output wattage for easy power demand management.
Sale \$624.94 **Tool Club \$499.95**



LEAK DETECTION



UV414565A Spotgun / UV Phazer Black Rechargeable Leak Detection Kit

Includes Rechargeable UV Phazer Black, Spotgun injection system, A/C ExtenDye cartridge (8oz), service stickers, UV glasses & case.
Sale \$228.69 **Tool Club \$182.95**



UV332005A Spotgun Jr / UV Phazer Black Leak Detection Kit

Includes: UV Phazer Black (UV413075), Spotgun Jr injection system, (4) 1oz. UV dye cartridges, service stickers, and UV glasses.
Sale \$137.44 **Tool Club \$109.95**



DYE

Part #	Size	Fits	Sale	Club
UV488016E	16 oz. - Ester	Universal	\$21.19	\$16.95
UV499108A	8 oz.	Spotgun	\$63.13	\$50.50
UV399020A	(4) 1 oz.	Spotgun Jr	\$55.63	\$44.50
UV499005	4 oz.	Universal	\$48.13	\$38.50

MSC55600 Infrared Refrigerant Leak Detector

Moving the sensor back and forth until the alarm sounds the IR sensor zeros out when held over a leak. Responds to all halogenated refrigerants. R134a, R410A, R22, R1234yf.
Sale \$474.94 **Tool Club \$379.95**



MSC56200 "Raptor" Refrigerant Leak Detector w/ UV Light

Detects leaks as small as 1/10 oz per year. 16" flexible probe. 3 levels of sensitivity. Detects all refrigerants (CFC's, HCFC's, HFC's) 6 Levels of Sensitivity (15 Levels of Detection) Ultra Bright UV/Blue LED Light
Sale \$249.94 **Tool Club \$199.95**



MSC91046A A/C System Flush Kit

Works with any light weight A/C flushing agent mixed with pressurized air.
Sale \$59.99 **Tool Club \$47.99**



UV LIGHTS

UV413065 UV Phazer BLACK Rechargeable UV LED Light

True UV LED. Adjustable lens focus. Compact, aluminum housing. Rechargeable lithium-ion battery lasts up to 2 hours. Includes UV glasses.
Sale \$99.69 **Tool Club \$79.75**



UV413075 UV Phazer Black

Uses AAA batteries.
Sale \$78.13 **Tool Club \$62.50**



UV413020 Pico-Lite

Compact leak detection light. 1 watt Luxeon LED. Includes 3 AA batteries and UV glasses.
Sale \$73.44 **Tool Club \$58.75**



SLT66148 Stylus Pro USB UV Rechargeable Pen Light

90 lumens. Comes with 120V AC Adapter, USB Cord, & Nylon Holster. Lasts up to 6.5 Hours
Sale \$81.19 **Tool Club \$64.95**



FJC4968 Rechargeable Work Light with UV Leak Detection Light

Three lighting modes. High efficiency COB LED.
Sale \$62.44 **Tool Club \$49.95**



WILW2648 FirePoint X UV Flashlight

365-395nm UV light. DuoFocus beam. Water & impact resistant. 2 hour runtime, 15m beam distance. Batteries Includes (2AA).
Sale \$29.94 **Tool Club \$23.95**



OIL

Part #	Description	Sale	Club
FJC2432	Estercool Oil - Quart	\$22.81	\$18.25
FJC2439	Estercool Oil - Gallon	\$74.94	\$59.95
FJC2445	Estercool Oil w/ Dye - Quart	\$31.19	\$24.95
FJC2480	Universal PAG Oil w/ Dye	\$37.44	\$29.95
FJC4946	Fluorescent Dye Cleaner	\$22.19	\$17.75

MSC85530 3-in-1 Side Mount Can Tap Valve

For R134a, R12, & oil charge cans.
Sale \$15.63 **Tool Club \$12.50**



FJC6842 3 Way Can Tap

For R12, R134a, & R1234yf.
Sale \$28.13 **Tool Club \$22.50**



INJECTORS

UV330500YF Spotgun Jr™ Injection Kit

Serves 6 vehicles. Includes Six (6) A/C ExtenDye cartridges, R-1234yf adapter, and service stickers.
Sale \$149.94 **Tool Club \$119.95**



UV471500A Spotgun Injection Kit

Serves up to 64 vehicles. Includes low-side hose, R12 and R134a adapters.
Sale \$170.94 **Tool Club \$136.75**



FJC2732 Hand Turn Oil & Dye Injector

2oz. refillable R12/R134a cylinder for adding oil, dye & STOP Leak.
Sale \$105.63 **Tool Club \$84.50**



UV481500YF PAG 46 Oil Spotgun™ HFO Oil Injection Kit

Includes R-1234yf adaptor and PAG 46 HFO oil cartridge.
Sale \$99.94 **Tool Club \$79.95**



FJC2734 R134a Oil Injector

Use injector to add 2 oz. of oil to an R134a air conditioning system.
Sale \$49.94 **Tool Club \$39.95**



MSC82375 R-134a Oil Injector

With low side quick coupler.
Sale \$48.13 **Tool Club \$38.50**



MSC81290 Universal Valve Core Remover / Installer

For R12 & R134a.
Sale \$8.69 **Tool Club \$6.95**



MSC91000A Clutch Puller

Serves most vehicles, domestic & imports. Includes a compressor identification chart & blow molded case.
Sale \$112.44 **Tool Club \$89.95**



A/C COUPLERS

MSC98370 R12-to-R134a A/C Manifold Conversion Kit

Sale \$64.38 **Tool Club \$51.50**



MSC82834 High Side MSC82934 Low Side

Sale \$37.44 **Tool Club \$29.95**



MSC82214 High Side Swivel MSC82224 Low Side Swivel

Sale \$49.06 **Tool Club \$39.25**



FJC6011 R134a Manual Coupler Set

Sale \$56.19 **Tool Club \$44.95**



RA15600
6 CFM Vacuum Pump
 2 Stage pump.
 Best in class.
 Sale \$662.44
Tool Club \$529.⁹⁵



MSC90062-BL
3 CFM Vacuum Pump
 Ultimate Vacuum:
 80 microns.
 1/4 HP motor.
 Sale \$174.94
Tool Club \$139.⁹⁵



MSC90066-BL
6 CFM Vacuum Pump
 Ultimate Vacuum:
 80 microns.
 1/3 HP motor.
 Sale \$224.94
Tool Club \$179.⁹⁵



FJC6930
R-1234yf / R134a
5 CFM Vacuum Pump
 1/3 HP motor.
 12oz Oil Capacity.
 Spark-proof series.
 Voltage: 115V, 60Hz
 Supplies with 2 ports:
 R134a and R1234yf.
 Sale \$299.94
Tool Club \$239.⁹⁵



NEW!
FJC6072
8pc R-134a
Manifold/Hose
Adapter Assortment
 Sale \$57.44
Tool Club \$45.⁹⁵



FJC6820
R1234YF Conversion Kit
 6pc kit with manual couplers.
 Sale \$124.94 **Tool Club \$99.⁹⁵**

1234YF



MSC83834
Red High Side R1234yf Coupler
 Sale \$51.88 **Tool Club \$41.⁵⁰**

Mastercool
 "World Class Quality"



MSC83934
Blue Low Side R1234yf Coupler
 Sale \$51.88 **Tool Club \$41.⁵⁰**



RA13203
1 Quart Vacuum Pump Oil
 Sale \$12.49
Tool Club \$9.⁹⁹



RA13204
1 Gallon Vacuum Pump Oil
 Sale \$37.44
Tool Club \$29.⁹⁵



A/C GAUGES

NEW! **Mastercool**
 "World Class Quality"
MSC84472
R134a Compact
Digital Manifold Gauge
 72" Hoses R134a
 Manual couplers.
 Large 4-digit "blue"
 backlit LCD display.
 Zippered carry case.
 Sale \$287.44 **Tool Club \$229.⁹⁵**



NEW! **Mastercool**
 "World Class Quality"
MSC82172
R1234YF Compact
Digital Manifold Gauge
 72" Hoses R1234YF
 Manual couplers.
 Large 4-digit "blue"
 backlit LCD display.
 Zippered carry case.
 Sale \$299.94 **Tool Club \$239.⁹⁵**



Mastercool
 "World Class Quality"
MSC89661-PRO
Automotive R-134a Manifold Gauge Set
 Complete with 60" hoses and aluminum
 manual couplers. Large knobs and extra
 large sight glass.
 Sale \$162.44 **Tool Club \$129.⁹⁵**



RA45111
R134a Manifold Hose Kit
 Brass manifold. R12/R134a
 gauges, PSI & °F Temp.
 1/2" ACME bottom
 ports. 90° manual
 couplers. 72" hoses.
 Sale \$231.19 **Tool Club \$184.⁹⁵**



FJC6785
R134a
Manifold Set
 Aluminum manifold.
 72" Hoses. R134a
 manual service
 couplers. Valve core
 tool, R134a can tap,
 pocket thermometer
 Sale \$174.94 **Tool Club \$139.⁹⁵**



1234YF

FJC6850
R1234YF Manifold Gauge Set
 Includes: Aluminum manifold with pressure
 gauges, high and low side service port
 couplers and 72" hoses packed in a
 protective plastic case.
 Sale \$206.19 **Tool Club \$164.⁹⁵**



FJC4415
637pc Deluxe Service
Item Assortment
 High-temperature HNBR
 construction on all o-rings.
 O-ring wall chart included.
 Resistant to aggressive
 chemicals and abrasion.
 Sale \$412.44 **Tool Club \$329.⁹⁵**



FJC6045
R-134a U-Charge Hose
for Self-sealing Valve Cans
 Sale \$24.94 **Tool Club \$19.⁹⁵**



FJC6037
R-134a U-Charge Hose and Gauge
for Self-sealing Valve Cans
 Sale \$31.24 **Tool Club \$24.⁹⁹**



FJC6845
R-1234yf Charging Hose
 For R-1234yf self-sealing valve can tap.
 Sale \$28.13 **Tool Club \$22.⁵⁰**



FJC2805YF
R-1234yf Refrigerant Check Gauge
 Checks low-side operating pressure.
 Sale \$31.19 **Tool Club \$24.⁹⁵**



FJC2805
R-134a Refrigerant Check Gauge
 Checks low-side operating pressure.
 Sale \$34.94 **Tool Club \$27.⁹⁵**



FJC6072YF
R-1234yf Manifold/Hose
Adapter Assortment
 Common adapter fittings for hoses
 on R-1234yf manifold gauge sets
 Sale \$62.44 **Tool Club \$49.⁹⁵**



FJC2850
Pro-Charge Electronic Scale
 H.D. die-cast aluminum refrigerant
 scale. 175 lb capacity. Accurate to
 +/- 1/2oz. or 0.5% of total weight.
 Sale \$249.94 **Tool Club \$199.⁹⁵**



MSC98210-BL
Electronic Scale
 Allows user to program
 desired quantities.
 Indicates amount of
 refrigerant left in tank.
 Allows user to know
 amount of refrigerant
 left in tank at any time.
 Sale \$249.94 **Tool Club \$199.⁹⁵**



FJC2806
Hand-Held Hydraulic
Crimper Kit for A/C Hoses
 Quick-snap dies don't
 require pins or screws.
 Complete die set.
 For sizes: #6, #8, #10,
 #12 & reduced barrier hose sizes.
 Sale \$474.94 **Tool Club \$379.⁹⁵**



Mastercool
 "World Class Quality"

MSC71550
Manual Crimping Tool
 Sizes: 6, 8, 10, & 12.
 Dies snap quickly into place.
 Can be easily mounted to a bench or vise.
 Sale \$299.94 **Tool Club \$239.⁹⁵**



RAAC1234-9

R-1234YF A/C Recovery Machine

- Incorporated Wi-Fi & Bluetooth wireless technology.
- Huge 10.5" hi-res touch screen with easy-to-use controls.
- For use with automotive R-1234YF systems.
- Integrated refrigerant analyzer protects machine and vehicle system.
- Built-in training videos & speaker with web access for more training & A/C service info.

CALL FOR BEST PRICE

1234YF



RAAC1234-6

R-1234YF Recover/Recycle/Recharge

- Fully automatic operation.
- 98.5% recovery efficiency.
- Programmable vacuum operation.
- System leak test to identify gross leaks in a system.
- Charge accuracy within +/- 1/2 oz.
- Integrated refrigerant identifier.
- On-Board printer.

CALL FOR BEST PRICE

1234YF



RAAC1234-4

R-1234YF Recover/Recycle/Recharge

- Does not come with printer

CALL FOR BEST PRICE

RA34788NI

Premier R-134A Recovery/Recycle/Recharge

- 98.5% recovery efficiency
- Refrigerant Identifier.
- Fully automatic.
- Newest addition to the fleet.

CALL FOR BEST PRICE

R134a



RA34788NI-H

For Hybrid & NonHybrid Vehicles

Does not use oil injection.

CALL FOR BEST PRICE

R134a HYBRID



MSS-ACX2180

ArcticPRO 134A RRR Machine

- 7" touch screen.
- Used for 134A only.
- UV dye injector.
- Data management & reporting metrics.
- Best in class service & support.

CALL FOR BEST PRICE

NEW!

MAHLE



MSS-ACX2280

ArcticPRO 1234YF RRR Machine

- 7" touch screen.
- Used for 1234YF only.
- UV dye injector.
- Data management & reporting metrics.
- Best in class service & support.
- Integrated refrigerant identifier.
- Automatic oil management system.

CALL FOR BEST PRICE

CPSMX3030

R-134a & R-1234yf

Refrigerant Management System

This dual refrigerant unit provides full YF recovery, recycle, and recharge capabilities and can convert to an R-134a to service a sudden increase in demand or replace a non-working R-134a machine. 60" H x 27.5" W x 25 D. 115V & 850W. 220 lbs. capacity. Two 30lb recovery tanks.

CALL FOR BEST PRICE

NEW!

R134a

1234YF



CPSMX134A

R-134a Refrigerant Management System

7" Color touch-screen control panel. WIFI Printer. Thermal Printer (Optional) Car health checks with the power of TAC100 (Bluetooth Wireless) Optional maximum load up to 220 lbs (100 kg). Refrigerant Management System monitors filter life and refrigerant usage.

CALL FOR BEST PRICE



MSC69372

R134a/R1234yf

Complete A/C Recovery Set

Approved for all A/C refrigerants including A2L & A3 flammable refrigerants. Built with the safest spark-free components. Includes all hoses and couplers needed to recover, cleanse and remove the oil from R134a and R1234yf automotive A/C systems as well as an extra filter dryer for replacement.

Sale \$2,249.94 **Tool Club \$1,799.95**

NEW!



FJC9281YF

Vacuum Pump & Gauge Set - R-1234YF

Includes R-1234yf aluminum manifold gauge set with anti-flutter design, manual couplers & adapters, & 72" hoses. Sparkproof 5.0 CFM Twin Port 1/3 HP vacuum pump.

Sale \$424.94 **Tool Club \$339.95**



FJC9281

Vacuum Pump & Manifold Gauge Kit - R134A

Includes brass manifold gauge set and 3.0 CFM twin port vacuum pump. Anti-flutter design gauges. Micron Rating: 75. 1/3 HP motor.

Sale \$249.89 **Tool Club \$199.91**



RA34724

Recycling Filter-Driers

Spin-on filter for Robinair 34788 machine.

Sale \$93.69 **Tool Club \$74.95**



LANG13800

Digital Pocket Thermometer

Measures -58°F to 572°F.

Sale \$30.31 **Tool Club \$24.25**



MSC52220

Pocket Analog Thermometer

Measures 0 to 220° F. Sale \$9.94

Tool Club \$7.95



MSC52223A

Dial Pocket Digital Thermometer

Measures 58° to 302° F.

Sale \$26.19 **Tool Club \$20.95**



TOPDON

TOP-TD52110063

TOPDON Phoenix MAX

- Connect to the newest vehicles & technology.
- 13.3" LCD Screen, 8-Core 2.0 GHz Processor & Android 9.
- All data in one view. Topology map granting a clear picture of related vehicle systems & status.
- Clearly defined CAN network layout. Diagnose communication issues in one glance.
- Step-by-step guided diagnostics process, based on code, for VAG Vehicles.
- Expand coverage to include ADAS Calibrations by upgrading your tablet.
- The included Phoenix Scope allows you to diagnose component and circuit faults with even more precision. With its color-coded channels, you can analyze and compare multiple components with ease.
- Vehicle Auto VIN & Autodetect
- Automatically capture the vehicles VIN number & determine all relevant information to auto populate the vehicle.

Sale \$3,937.44 **Tool Club \$3,149.95**

NEW!



DIAGNOSTICS

H.D./TRUCK DIAGNOSTIC SCANNERS

AUTEL

ATLMS909CV

H.D. Scan Tool Kit

- Compatible with over 80 light, medium, and heavy duty commercial vehicles.
- 9.7" Wireless Android-based touchscreen diagnostics tablet.
- Octa-core Processor with 128GB of Internal Storage.
- Wireless Vehicle Communication Interface (VCI).
- J2534 Passthru Programming Device.
- Topology Module Mapping, Guided Repair, Detailed Repair information including TSB and OE Campaigns.
- Performs Starting and Charging Systems Analysis with included MaxiBAS B200 tester with alligator clamps.
- Includes Multimeter & Amp Clamp.
- ADAS Calibration Software for Class 3-5 vehicles and Class 6 to 8 Vehicles with Dynamically Calibrated Systems.
- Rapid Vehicle Identification via VINscan and AutoVin.
- Includes One Year Limited Warranty and Free Software Updates

Sale \$5,743.75 **Tool Club \$4,595.00**



CANDOHD CODE II HD Code II Heavy Duty Code Reader



- Covers Class 4-8 HD Trucks
- Access Engine, Transmission & Brakes
- Automatic protocol search
- Capabilities for Caterpillar, International, Hino, Isuzu and Hybrid HD trucks
- Read & clear DTCs
- Special tests include: I/M Readiness, MIL Status, O2 Sensor Test, On-Board Monitor Test and EVAP System Test.
- Easy-to-read Large Screen

Sale \$474.94 **Tool Club \$379.95**



ATLMS906CV MaxiSys MS906CV

- 8" LED touch screen with Android
- 32GB solid state drive
- Rechargeable li-ion battery
- Coverage for 80+ vehicles
- Smart AutoVIN technology
- Instant remote control tech support
- Automatic software updates
- Code, live data, active test, etc.

Sale \$1,749.94 **Tool Club \$1,399.95**

AUTEL



AUTEL

ATLAL529HD

AutoLink HD Code Reader w/ Deutsch-9 and Deutsch-6 Adapters For Heavy Duty Vehicles

- Compatible with H.D. Vehicles utilizing SAE-J1939 and SAE-J1708 protocols
- Compatible with Domestic, Asian and European vehicles
- AutoVIN function for quick manufacturer-specific code identification
- Reads enhanced codes in Powertrain system for Ford, GM & Chrysler
- Enhanced OBDII Mode 6 access
- Reads, stores & plays back live sensor data.

Sale \$187.44 **Tool Club \$149.95**



TOPDON

NEW!

HD KIT

TOP-HDKIT

Heavy-Duty Software & Cable Set

Turn your Phoenix Smart, Remote, or Max into a robust heavy duty diagnostic tool with this kit. With the TOPDON truck, bus, and machinery software you can expand your offering and revenue.

- 1 Year Heavy Duty Software
 - 6 Pin Connector
 - 9 Pin Connector (Type 1 & Type 2 Compatible)
- Sale \$624.94

Tool Club \$499.95



ATLAL329
Autolink CAN OBDII
Code Reader/Scan Tool
 Works on ALL 1996+ domestic and import vehicles (OBD II & CAN).
 Sale \$74.94 **Tool Club \$59.95**



ATLMD808PRO
MaxiDiag MD808 Pro
 Support read / clear codes and live data functions for ALL systems.
 Test BMS / Oil Reset / SRS / EPB / DPF.
 Oil service reset.
 Battery registration and reset.
 Diesel particulate service.
 Reset service mileage and service intervals.
 Reset SAS functionality.
 Relearn parking brake pad.
 All OBDII protocols.
 Sale \$399.94 **Tool Club \$319.95**



ATLMF2534
MaxiFlash Pro - J2534
 Fully compatible with both SAE J2534-1 and J2534-2 reprogramming standards.
 Performs the standard PassThru J2534 functionality.
 Compatible with Toyota Techstream, Volvo VIDA, Honda HDS, Jaguar, Land Rover IDS and BMW 3G for OEM diagnostics
 Sale \$1,249.94 **Tool Club \$999.95**



ATLMFVCM1
MaxiFLASH VCM1
 Built-In 4 channel Oscilloscope, Multimeter, Signal Generator, and OBD Bus Check Functions.
 Supports D-PDU, RP1210, CANFD, J2534 & DoIP protocols.
 Sale \$1,624.94 **Tool Club \$1,299.95**



AUTEL **NEW!**

ATLMX900
ADVANCED SERVICE + ALL SYSTEM DIAGNOSTICS
 8" corded Wi-Fi-enabled touchscreen table
 Compatible with U.S., Asian, and European vehicles, 1996 and newer. Read and erase codes, view and graph Live Data, view Freeze Frame data. Perform bi-directional Active Tests and Special Functions Extensive, 40-plus Service Menu. Android 11OS, 1.8 Ghz processor, and 7 hours of continuous battery life
 Update firmware and coverage software wirelessly
 One Year Limited Warranty
 Sale \$624.38 **Tool Club \$499.50**



TOP-AD800BT
Wireless Bluetooth Mid-Level Diagnostic Scan Tool

- Engine, Transmission, Airbag, ABS, ESP, TPMS, Immobilizer, Gateway, Steering, Radio, Air Conditioning, etc.
- This OBD2 scanner uses AutoVIN technology
- Oil light reset, Throttle matching, SAS calibration, DPF reset for diesel engine and many other maintenance services, brands covered are continuously updated.

Sale \$562.44 **Tool Club \$449.95**



TOP-TD52110042
TOPDON Phoenix Elite

- Connect to the newest vehicles & technology.
- 10.1" LCD Screen, 4-Core 2.0 GHz Processor & Android 10.
- All data in one view. Topology map granting a clear picture of related vehicle systems & status.
- Clearly defined CAN network layout. Diagnose communication issues in one glance.
- Step-by-step guided diagnostics process, based on code, for VAG Vehicles.
- Expand coverage to include ADAS Calibrations by upgrading your tablet.
- The Pre-Scan & Post Scan feature allows the technician the ability to record the codes prior to repair. This allows submission the customer or insurance company for repair approval.
- Vehicle Auto VIN & Autodetect
- Automatically capture the vehicles VIN number & determine all relevant information to auto populate the vehicle.

Sale \$1,687.44 **Tool Club \$1,349.95**



EPY'S SELLS ADAS EQUIPMENT! OTHER MODELS AVAILABLE! CALL FOR DETAILS.

ATLIA900WA
Wheel Alignment and ADAS calibration

- Frame capable of performing 4-Wheel alignment and ADAS calibration
- Six high-resolution positioning and tracking cameras in frame
- Includes 24" touchscreen display that attaches to frame unit
- MaxiSYS software interface monitors and displays alignment measurements
- Cameras automatically track vehicle height on shop lift
- Robotic frame movement
- Alignment coverage includes U.S., Asian and European vehicles, 1996 and newer Illustrated alignment instructions, live readings, required tools and adjustment locations display on a single screen.
- Includes four-wheel clamps with camera targets, steering wheel lock and wheel chocks.
- Other targets available for purchase.

CALL FOR BEST PRICE





AUTEL®

DIAGNOSTICS

ATLMS-ULTRA

MaxiSYS ULTRA with MaxiFLASH VCMi

- Features a 13" touchscreen tablet with Android 7.0 OS
- Powered by an Octa-core processor (2.3GHz Quad + 1.7GHz Quad)
- Substantial 256GB built-in memory
- Combined with the dynamic topology module mapping, enhanced AutoSCAN features and Intelligent Diagnostics options, the Ultra offers the technicians step-by-step repair guidance.
- The new MaxiFlash VCMi functions as a 4-channel oscilloscope, waveform generator, multimeter, and CAN BUS tester.
- The convenient docking station featured ensures you always have the power to scan.
- Autel updates provide latest OE level coverage for more than 80 US Domestic, Asian and European vehicles, including supercar.
- One-stop multitasking designed for ideal management of workshop operations to keep all data files, customer info, and vehicle records well organized
- Includes 1 year warranty / 1 year FREE software updates



5-IN-1 VCMi

Sale \$6,249.94 Tool Club \$4,999.⁹⁵

ATLMS909

MaxiSYS MS909 with MaxiFLASH VCI

- Features a 9.7" touchscreen tablet with Android 7.0 OS
- Powered by an Octa-core processor (2.3GHz Quad + 1.7GHz Quad)
- Substantial 128GB built-in memory
- Features vehicle diagnostics for passenger/light duty vehicles
- Basic & special functions for US, Asian & European vehicles 1996 & newer
- OBDII Test Modes live & freeze frame/enhanced mode 6
- 26 service reset features
- Resets diesel emissions on light & medium duty vehicles
- Bi-directional control & advanced coding & adaptations
- Covers all domestic, Asian and European vehicle manufacturers (1996 to present).
- TPMS antenna triggers all known sensors / clone and program Autel MX-Sensors.
- Oil service reset, TPMS relearn, EPB, ABS/ SRS, SAS.
- Includes 1 year warranty / 1 year FREE software updates



Sale \$4,062.44 Tool Club \$3,249.⁹⁵

ATLMS906PRO-TS

MaxiSYS MS906Pro-TS with Bluetooth VCI

- Features an 8" touchscreen tablet with Android 10.0 OS
- Powered by a Qualcomm 660 Octa-Core Processor
- Substantial 128GB built-in memory
- MaxiVCI V200 wireless Bluetooth vehicle communication interface supporting the latest communication protocols
- Comprehensive diagnostics on 1996 & newer U.S., Asian & European vehicles
- Scan all available systems, including ADAS identification
- Read/Erase codes, view freeze frame & live data
- Perform active tests (bi-directional controls), coding & adaptations
- AutoVIN/Scan VIN for rapid vehicle identification
- Performs ADAS Calibrations with software upgrade & frame system purchase
- Comprehensive TPMS service, including the ability to activate & relearn all known sensors, & program the Autel 1-Sensor to replace 99% of TPMS sensors on the road today



NEW!

Sale \$2,474.94 Tool Club \$1,979.⁹⁵

ATLMS906PRO

MaxiSYS MS906Pro

- Features an 8" touchscreen tablet with Android 10.0 OS
- Powered by a Qualcomm 660 Octa-Core Processor.
- Substantial 128GB built-in memory
- MaxiVCI V200 wireless Bluetooth vehicle communication interface supporting the latest communication protocols
- Comprehensive diagnostics on 1996 & newer U.S., Asian & European vehicles
- Scan all available systems, including ADAS identification
- Read/Erase codes, view freeze frame & live data
- Perform Active Tests (bi-directional controls), Coding & adaptations
- AutoVIN/Scan VIN for rapid vehicle identification
- Perform ADAS Systems calibrations with additional purchase.



NEW!

Sale \$1,937.44 Tool Club \$1,549.⁹⁵



ATLIM608PROIHKPA

- Powerful combination of advanced key programming/all systems diagnostics/ advanced maintenance services • Professional key programming equipped with XP400 key programmer & MaxiFlash • ECU programmer for complete Immo coverage • Smart mode for guided & automated key learning
 - Expert mode for advanced key learning • Read PIN/CS (all key lost), generate key, key learning, remote learning • IMMO ECU reset/adaptation, refresh/coding
 - Read/write transponder data, ECU/MCU/EEPROM data (eg. 9S12 encryption chip), IC card, detect remote frequency • Powerful OE level diagnostics for more than 80 US, Asian and European makes and models • All special functions, EPB, DPF, SAS, Oil reset, BMS, TPMS sensor ID relearn, etc.
 - 10.1-inch LED capacitive touch screen with 128 GB On-Board Memory
- Sale \$4,744.94 **Tool Club \$3,795.95**



ATLKM100

MaxiIM Universal Key Generator Kit

An advanced key and immobilizer touch-screen tablet capable of smart key creation and IMMO learning via OBD. This 5.5-inch, Android touchscreen tablet with Bluetooth VCI can program the Autel IKEY as a smart key replacement for more than 700 vehicles and offers IMMO programming capability (Autel Universal Only).
 Transponder Reading/Writing/Cloning
 Frequency detection & ignition coil detection.
 Key Renewal: supporting 36 vehicle makes.
 Transponder Editing: Supporting 20 categories. Dual-Band, High Frequency
 Transmitter 315m/434m or 868m/915m supporting certification requirements of various regions. Supporting PLC V200.
 Sale \$624.94 **Tool Club \$499.95**



ATLOTOWATCHBV

**OTOFIX Smart Watch with VCI - Black
 ATLOTOWATCHHW**

OTOFIX Smart Watch with VCI - White

- Wearable smart key that does everything your vehicle's smart key does.
 - Performs smart key functions including Lock, Unlock, and Remote Start when programmed to vehicle.
 - Comes with VCI to program Smart Watch to the vehicle & use smart key functions.
 - Make and receive calls and texts when paired with a phone (iOS and Android).
 - Health monitoring and reminder apps inc. sleep, heart rate, pulse oxygen, stand and breathe.
 - More than 12 exercise and sports apps inc. running, walking, hiking, yoga, cycling – 45 mm high-definition touchscreen, white case, and band.
 - Voice Control: Tell Watch to Remotely Start Car, Lock, Unlock Doors and Trunk
 - Free Autel Link app tracks health and exercise history.
- Sale \$374.94 **Tool Club \$299.95**



KEY CUTTING & PROGRAMMER

XTO-NITRO-XT-SYS

Master Key Making System

This Complete Key Making System comes with everything you need to stock, build and program keys.

- Covers over 80% of the North American market.
- The key making process can be explained in 3 easy steps.
- Identify the Correct Product Go to nitrouskeys.com.
- Pick the desired remote from your Nitrous Keys remote bundle or MFK set.
- Cut the Key Blade Use the Triton Key Cutting Machine to decode and duplicate the existing key.
- Nitro XT Diagnostic Scan Tool (XTU-NITRO-XT)
- Triton Key Cutting Machine (XTU-TRM1)
- Nitrous Keys Remotes - Complete Bundle for remote fobs, remote head keys and proximity smart keys (XTU-27301238)
- Nitrous Keys Full MFK Set Includes Heads, Blades and Chips for building transponder keys (XTU-27801294)

Sale \$12,000.00 **Tool Club \$9,600.00**



XTO-27801294

Nitrous Keys Full MFK Set (Heads, Blades & Chips)

- One single kit will provide the flexibility to create hundreds of mechanical keys in 24 of the most common keyways
 - Combine it with MFK Heads and a handful of chips and now you've got the power to create TONS of different transponder keys
 - Use as TEST KEYS : Using the reusable, blue universal head, cut these inexpensive blades and test in the lock before duplicating onto a more expensive transponder key or remote head key
- Sale \$955.31 **Tool Club \$764.25**



XTO-20201002

Key Making System

- Cuts 99% of contemporary automotive keys, right out of the box!
 - Brand-new, completely overhauled direct-drive motor
 - Integrated, proprietary key code database supports key cutting directly by code for most automotive keys, streamlining your workflow and eliminating the need to reference other code sources.
 - Comprehensive database of automotive, commercial & residential keys & can even generate dimple-cut keys.
 - Unlimited, free updates for the life of your machine via Wi-Fi.
- Sale \$5,368.75 **Tool Club \$4,295.00**



EPHY'S INDEX

A DJUSTABLE WRENCHES	42,43	FLARING TOOLS	103	PULLERS	71,78,79,82
AIR ACCESSORIES	26,27,28	FLARENUT WRENCHES	4	PUMPS AND RAMS	86,87
AIR COMPRESSORS	29	FLASHLIGHTS	23,24,25	PUNCHES	65
AIR COOLERS	26	FLOOR JACKS	59,60	R ADIATOR TOOLS	94,95
AIR CONDITIONING	116,117,118	FLUID EVACUATORS	96,98	RELAY TESTERS	108
AIR TOOLS	30,31,32,33,34	FILES	66	RIVET TOOLS	89
ALLEN/HEX KEYS	14,15,16	FRONT END	34,70	S AFETY / PPE	52
AXLE JACKS	60	FUEL INJECTION	69	SANDERS AND POLISHERS	32,88,91,90
AXLE SOCKETS	17,68	FUEL LOCK RING TOOLS	76	SCAN TOOLS	38,119,120,121,122
B ALL JOINT	70	FUEL TRANSFER	96	SCRAPERS	14,38,39,40
BATTERY CHARGERS	113	FUNNELS	77,104	SCREWDRIVERS	38,39
BATTERY TESTERS	112	G LOVES	52	SENSOR TOOLS	78
BATTERY TOOLS	110-115	GOJACK	59	SERPENTINE BELT	81
BEARING / SEAL TOOLS	78	GREASE GUNS / PUMPS	96,97,104	SHOP ASSORTMENTS	51,52,90,89
BEARING SPLITTERS	82	H AMMERS	64,84	SLACK ADJUSTERS	69,83
BENCH GRINDERS	63	HARMONIC BALANCER	79	SLAP HAMMERS	82,85
BIT SETS	14,15,16,40	HEAT GUNS	90	SMOKE MACHINES	50
BODY AIR TOOLS	32,33,90,91	HOOK AND PICK	38	SNAP RING PLIERS	43
BODY CLIP SETS	85	HOSE CLAMP PLIERS	94	SOLDERING	92
BODY HAMMERS	84	I MPACT SOCKETS	17,18,19,20,21	SPANNER WRENCH	81
BODY SHOP TOOLS	84-92	IMPACT ADAPTERS	21,40	SPARK PLUG TOOLS	46
BOOSTER CABLES	115	IMPACT EXTENSIONS	21	SPINDLE NUT SOCKETS	17
BOOSTER PACS	114,115	IMPACT TOOLS	30-37	SPRAY GUNS	88
BOROSCOPES	106	INSPECTION CAMERAS	106	STRUT TOOLS	71
BOTTLE JACKS	56,59	INSULATED TOOLS	44	T AP & DIE SETS	47
BRAKE SERVICE TOOLS	98,102,103	J ACK STANDS	58	TERMINAL TOOLS	106
BREAKER BARS	10	JUMP STARTERS	114,115	TEST LEADS	110
BUDD WHEELS	17	K EY PROGRAMMER	123	TEST LIGHTS	110
C AMSHAFT TOOLS	72,73,74	L IFTING EQUIPMENT	56,57,58,59	THERMAL IMAGING	106
CAR DOLLIES	59,91	LIGHTING	23,24,25	THERMOMETERS	106
C-CLAMP	63	LOCK OUT TOOLS	81	THREAD REPAIR	46,47,48,49,50
CHISELS	65	LUBRICATION	96-101	TIE ROD	83
CHROME ACCESSORIES	12,13	LUG SOCKETS	17	TIRE INFATORS	27,36
CHROME RATCHETS	9,10,11	M AGNETS AND MIRRORS	41	TIRE REPAIR	67
CHROME SOCKET SETS	6,7,8	MANIFOLD DRILL TEMPLATE	50	TOOL BOXES / CARTS	54,55,62
COME ALONGS	84	MEASURING TOOL	13	TOOL STORAGE	53
CORDLESS TOOLS	35,36,37	MEMORY SAVERS	108	TORQUE WRENCHES	11
CREEPERS	61	MILWAUKEE TOOLS	35,36,37,88,89	TORX	14,15,16
CRIMPERS	109	MO-CLAMP	84	TPMS	105
CROWSFOOT	4	MULTIMETERS	107,111	TRANSMISSION JACKS	57
D AMAGED LUG REMOVERS	48,49	O IL DRAINS	98,99	TRIPLE SQUARE	14,15,16
DIAGNOSTIC	106-115, 118-122	OIL SERVICE TOOLS	98,99,100,101	TRUCK JACKS AND STANDS	58,60
DIESEL PRESSURE TESTERS	76	OSCILLOSCOPE	111	TRUCK TOOLS	67,68,69
DISCONNECT TOOLS	97,100	P AINT GUNS	88	U NDERHOIST STAND	57
DRILL BITS	48,49,50	PLIERS	42,44,45,94	UNIBITS	49
DRILLS	36	PIPE WRENCHES	42	V ACUUMS	86
DRIVE LINE SOCKETS	22	POLISHERS	88	VALVE TOOLS	75
E LECTRIC TOOLS	44	PORTO-POWERS	86,87	WISE	63
ENGINE LIFT EQUIPMENT	56	POWER INVERTERS	112,115	WISEGRIP	45
ENGINE TOOLS	71-81	POWER PROBE	107	W ATER PUMP	81
EVACUATORS	98	POWER SUPPLY	112-115	WELDING	91,92,93
EXHAUST HOSE	83	POWER TOOLS	35,36,37,88	WHEEL / TIRE TOOLS	67,105
EXTENSIONS	12	PRESSES	62	WHEEL SOCKETS	17
EXTRACTORS	47,48,49	PRESSURE TESTERS	76,77	WINDSHIELD TOOLS	90
F AN CLUTCH	81	PRY BARS	66	WRENCHES	3,4,5,6

Eppy's Tool & Equipment Warehouse Inc.

809 E 42nd St
Brooklyn, NY 11210
718-434-7878
www.eppys.com

2777 Rt 9 N
Howell, NJ 07731
732-942-3700
sales@eppys.com

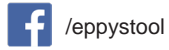

PRESORTED
STANDARD
U.S. Postage Paid
Aberdeen, SD
Permit #200

PRICES GOOD THROUGH MARCH 31, 2024

Due to the Ongoing Material Inflation Some Catalog Prices are Subject to Change before 3/31/2024. Shop at our NY/NJ showrooms! Eppy's offers a broad range of tools & equipment with over 100,000 quality products and quick local truck delivery! Some quantities limited. Not responsible for typographical errors.



PG.37



PG.120



PG.8



PG.115



PG.99



PG.113



PG.117



PG.93